

## Features

- Low THD, 10% Max up to 240 Vac
- High Efficiency (Up to 92%)
- Input Surge Protection: 4kV line-line, 6kV line-earth
- High Reliability & Long Lifetime: 97,000 hrs. at 70°C Case Temperature
- Suitable for Independent Use and Class I Luminaires
- Input UVP and Input OVP
- Waterproof (IP67)
- 5 Years Warranty

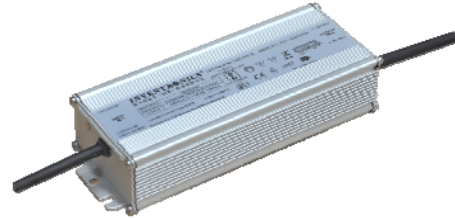

## Description

The EDC-150S105SV-000x is a 150W, constant-current, IP67 LED driver that operates from 140-305 Vac input with excellent power factor. It is created for high bay, tunnel and street lights. The high efficiency of these drivers and compact metal case enable them to run cooler, significantly improving reliability and extending product life. To ensure trouble-free operation, protection is provided against input surge, input under voltage, input over voltage, output over voltage, short circuit, and over temperature.

## Models

Output Current Range	Input Voltage Range(1)	Output Voltage Range	Max. Output Power	Typical Efficiency (2)	Power Factor (2)	Model Number
700 mA	140 ~ 305 Vac	107 ~ 214 Vdc	150 W	92.0%	0.96	EDC-150S105SV-0007
860 mA	140 ~ 305 Vac	97 ~ 174 Vdc	150 W	92.0%	0.96	EDC-150S105SV-0004
1050 mA	140 ~ 305 Vac	97 ~ 143 Vdc	150 W	91.0%	0.96	EDC-150S105SV

**Notes:** (1) Certified input voltage range: 220-240Vac.

(2) Measured at full load and 220Vac input.

## Input Specifications

Parameter	Min.	Typ.	Max.	Notes
Input Voltage	140 Vac	-	305 Vac	
Input Frequency	47 Hz	-	63 Hz	
Leakage Current	-	-	0.70 mA	IEC60598-1; 240Vac/ 60Hz
Input AC Current	-	-	1.0 A	Measured at full load and 220 Vac input.
Inrush Current(I <sup>2</sup> t)	-	-	0.54 A <sup>2</sup> s	At 220Vac input, 25°C cold start, duration=200 us, 10%lpk-10%lpk. See Inrush Current Waveform for the details.
PF	0.90	-	-	At 200-277Vac, 50-60Hz, 75%-100%load (112.5-150W)
THD	-	-	20%	

## Input Specifications (Continued)

Parameter	Min.	Typ.	Max.	Notes
THD	-	-	10%	At 220-240Vac, 50-60Hz, 75%-100%load (112.5~150W)

## Output Specifications

Parameter	Min.	Typ.	Max.	Notes
Output Current Tolerance	-8%Io	-	8%Io	Without power derating and full load condition
Startup Overshoot Current	-	-	10%Iomax	At full load condition
No Load Output Voltage EDC-150S105SV-0007 EDC-150S105SV-0004 EDC-150S105SV	- - -	- - -	250 V 250 V 250 V	
Line Regulation	-	-	± 5.0%	Measured at full load
Load Regulation	-	-	± 5.0%	
Turn-on Delay Time	-	-	0.5 s	Measured at 220Vac input, 75%-100% Load
Temperature Coefficient of Iomax	-	0.04%/°C	-	Case temperature = 0°C~Tc max

**Note:** All specifications are tested by Cree XLamp XP-G2 and typical measured at 220Vac and 25°C unless otherwise stated.

## General Specifications

Parameter	Min.	Typ.	Max.	Notes
Efficiency at 220 Vac input: EDC-150S105SV-0007 EDC-150S105SV-0004 EDC-150S105SV	90.0% 90.0% 89.0%	92.0% 92.0% 91.0%	- - -	Measured at full load and steady-state temperature in 25°C ambient; (Efficiency will be about 2.0% lower if measured immediately after startup.)
MTBF	-	616,000 Hours	-	Measured at 220Vac input, 80%Load and 25°C ambient temperature (MIL-HDBK-217F)
Lifetime	-	97,000 Hours	-	Measured at 220Vac input, 80%Load and 70°C case temperature; See lifetime vs. Tc curve for the details
Operating Case Temperature for Safety Tc_s	-40 °C	-	+90 °C	
Operating Case Temperature for Warranty Tc_w	-40 °C	-	+75 °C	Case temperature for 5 years warranty. Humidity: 10%RH to 100%RH
Storage Temperature	-40 °C	-	+85 °C	Humidity: 5%RH to 100%RH
Dimensions Inches (L x W x H) Millimeters (L x W x H)	6.54 x 2.66 x 1.56 166 x 67.5 x 39.7			With mounting ear 7.36 x 2.66 x 1.56 187 x 67.5 x 39.7
Net Weight	-	905 g	-	

**Note:** All specifications are tested by Cree XLamp XP-G2 and typical at 25°C unless otherwise stated.

## Safety & EMC Compliance

Safety Category	Standard
BIS	IS 15885(PART2/SEC13)
CCC	GB 19510.1, GB 19510.14
CE	EN 61347-1, EN61347-2-13
KS	KS C 7655
EMI Standards	Notes
EN 55015 <sup>(1)</sup>	Conducted emission Test & Radiated emission Test
EN 61000-3-2	Harmonic current emissions
EN 61000-3-3	Voltage fluctuations & flicker
EMS Standards	Notes
EN 61000-4-2	Electrostatic Discharge (ESD): 8 kV air discharge, 4 kV contact discharge
EN 61000-4-3	Radio-Frequency Electromagnetic Field Susceptibility Test-RS
EN 61000-4-4	Electrical Fast Transient / Burst-EFT
EN 61000-4-5	Surge Immunity Test: AC Power Line: line to line 4 kV, line to earth 6 kV
EN 61000-4-6	Conducted Radio Frequency Disturbances Test-CS
EN 61000-4-8	Power Frequency Magnetic Field Test
EN 61000-4-11	Voltage Dips
EN 61547	Electromagnetic Immunity Requirements Applies To Lighting Equipment

**Note:** (1) This LED driver meets the EMI specifications above, but EMI performance of a luminaire that contains it depends also on the other devices connected to the driver and on the fixture itself.

## Derating

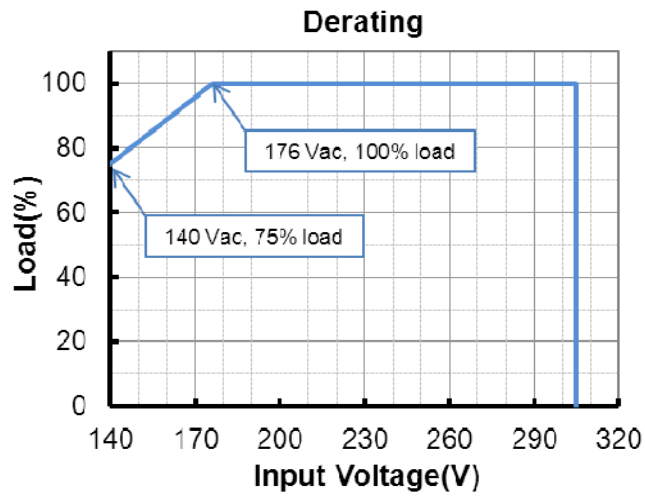

## Lifetime vs. Case Temperature

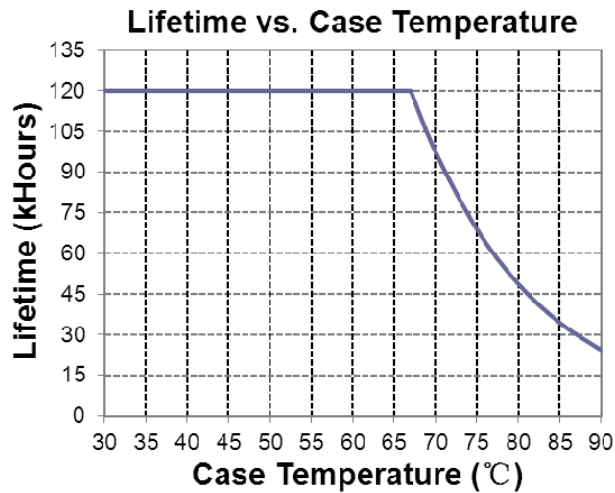

## Inrush Current Waveform

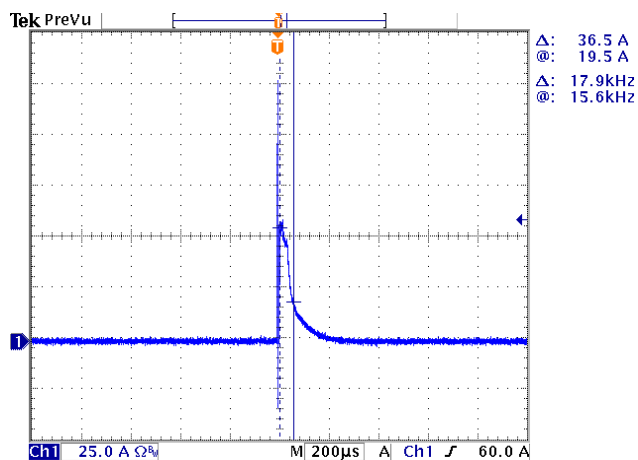

## Efficiency vs. Load

EDC-150S105SV( $I_o=1050mA$ )  
Efficiency vs. Output Voltage

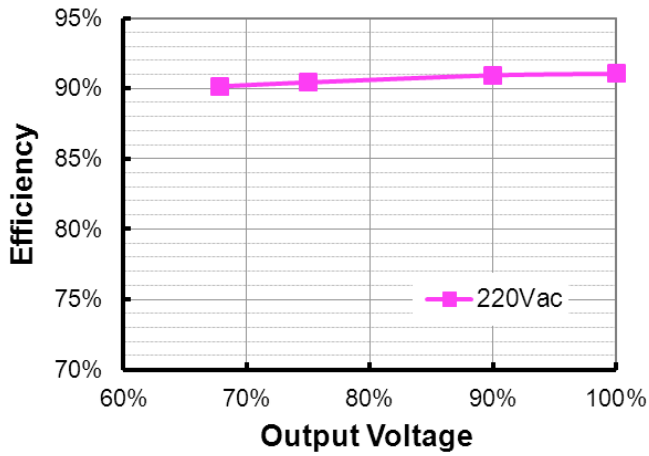

EDC-150S105SV-0004( $I_o=860mA$ )  
Efficiency vs. Output Voltage

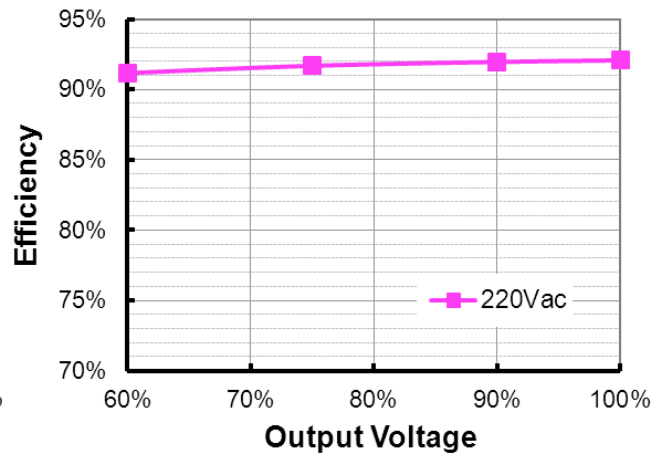

EDC-150S105SV-0007( $I_o=700mA$ )  
Efficiency vs. Output Voltage

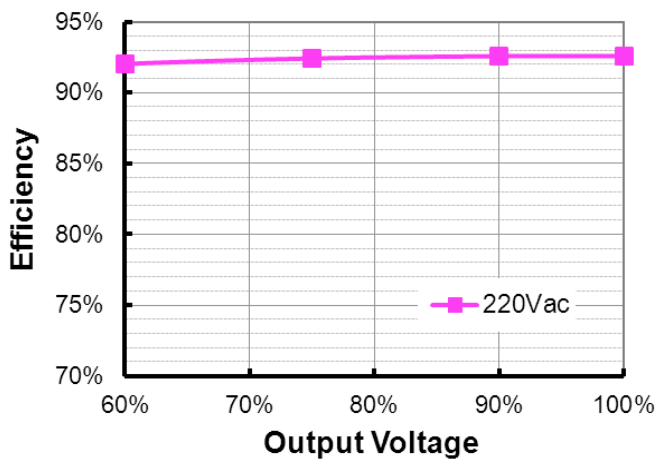

## Power Factor

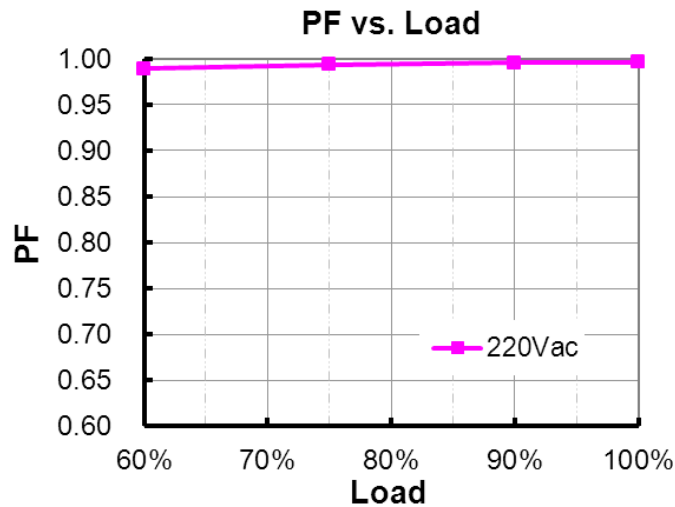

## Total Harmonic Distortion

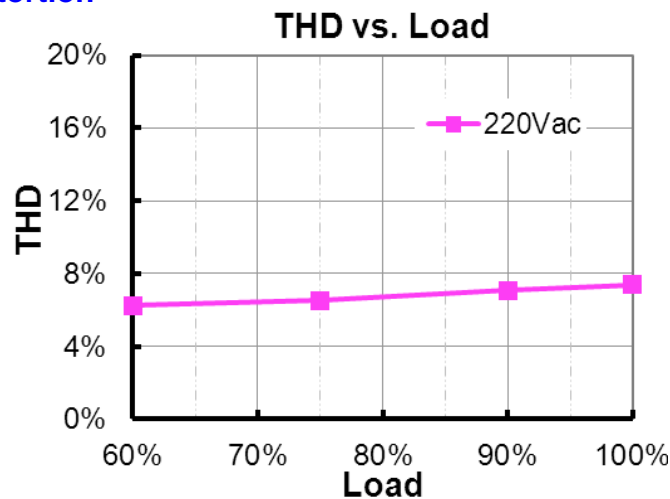

## Protection Functions

Parameter		Min.	Typ.	Max.	Notes
Over Voltage Protection		Limits output voltage at no load and in case the normal voltage limit fails.			
Short Circuit Protection		Auto Recovery. No damage will occur when any output is short circuited. The output shall return to normal when the fault condition is removed.			
Over Temperature Protection		Decreases output current, returning to normal after over temperature is removed.			
Input Under Voltage Protection		Auto Recovery. Turn off the output when the input voltage falls below 120V ± 15V. And the driver will restart when the input voltage is in normal.			
Input Over Voltage Protection	Input Over Voltage Protection	320 Vac	340 Vac	360 Vac	Turn off the output when the input voltage exceeds protection voltage.
	Input Over Voltage Recovery	300 Vac	320 Vac	340 Vac	Auto Recovery. The driver will restart when the input voltage falls below recovery voltage.

## Protection Functions (Continued)

Parameter		Min.	Typ.	Max.	Notes
Input Over Voltage Protection	Max. of Input Over Voltage	-	-	440 Vac	The driver can survive for 48 hours with input over-voltage of 440Vac.

### ● Input Over Voltage Protection Diagram

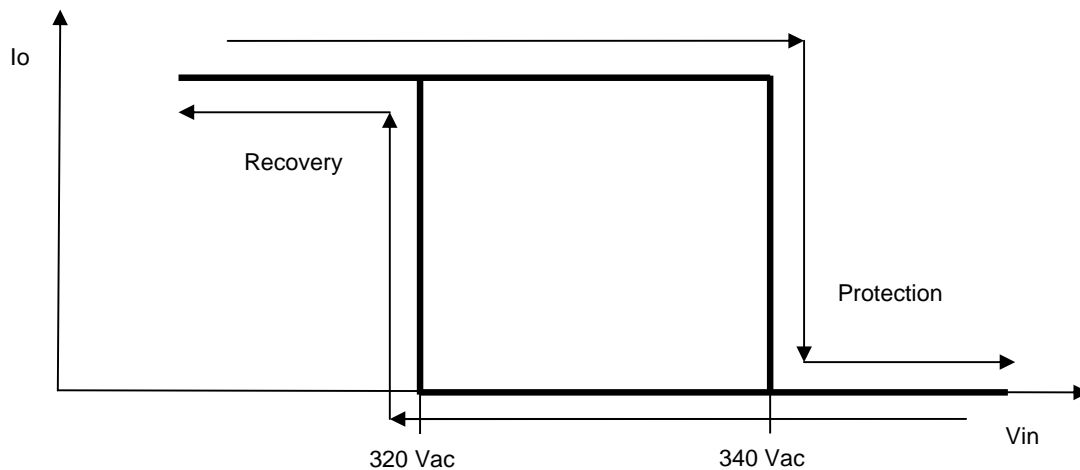

## Mechanical Outline

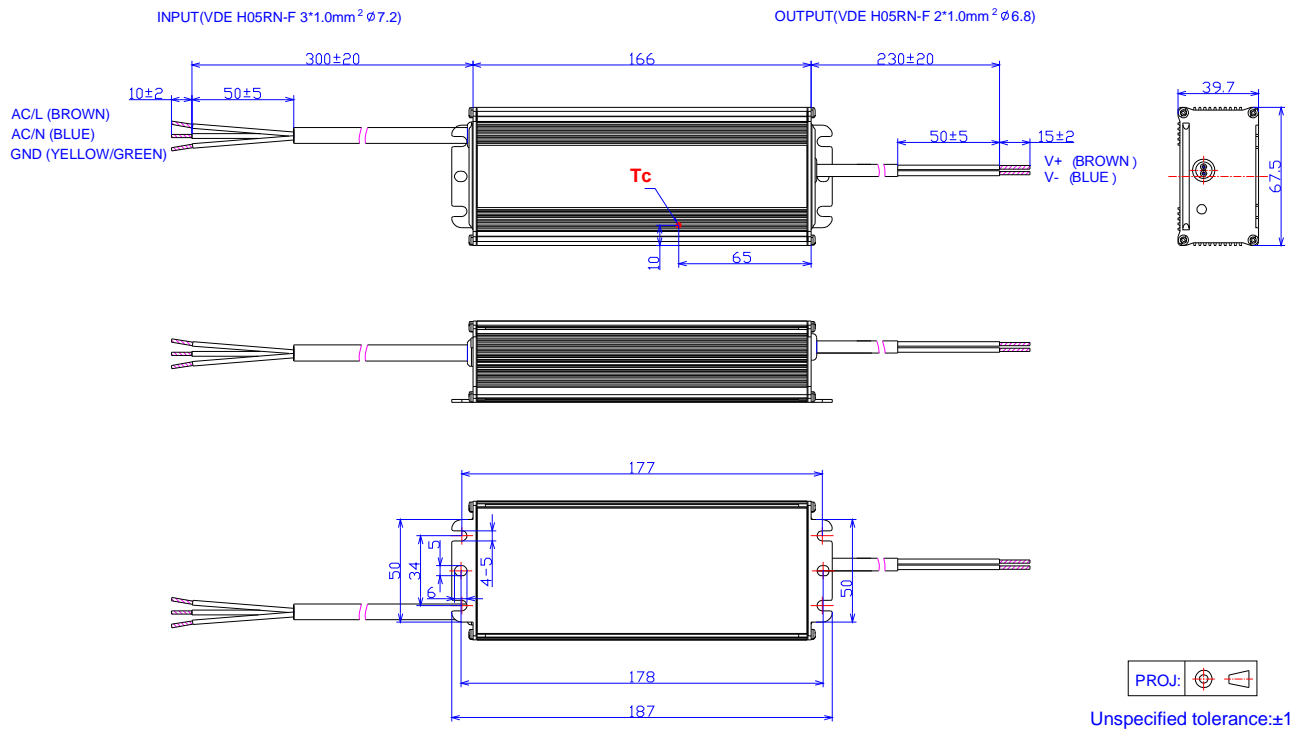

## RoHS Compliance

Our products comply with the European Directive 2011/65/EC, calling for the elimination of lead and other hazardous substances from electronic products.



## Revision History

Change Date	Rev.	Description of Change		
		Item	From	To
2017-03-03	A	Datasheet Release	/	/