

## Features

- High Efficiency (Up to 91%)
- Active Power Factor Correction (0.99 Typical)
- Constant Current Output
- 0-10V Dimming Control
- Input surge protection: 4kV line-line, 6kV line-earth
- All-Around Protection: OVP, SCP, OTP
- Waterproof (IP67)
- SELV



## Description

The EUC-085SxxxDV(SV) series is a 85W, constant-current LED driver that operates from 90-305 Vac input with excellent power factor. It is created for low bay, tunnel and street lights. The high efficiency of these drivers and compact metal case enables them to run cooler, significantly improving reliability and extending product life. To ensure trouble-free operation, protection is provided against input surge, output over voltage, short circuit, and over temperature.

## Models

Output Current	Input Voltage Range	Output Voltage Range	Max. Output Power	Typical Efficiency (1)	Power Factor		Model Number (2,3)
					120Vac	220Vac	
350 mA	90 ~ 305 Vac	121~243Vdc	85 W	91%	0.99	0.95	EUC-085S035DV(SV)
450 mA	90 ~ 305 Vac	94~189Vdc	85 W	91%	0.99	0.95	EUC-085S045DV(SV)
700 mA	90 ~ 305 Vac	61~121 Vdc	85 W	90%	0.99	0.95	EUC-085S070DV(SV)
1050 mA	90 ~ 305 Vac	40~81 Vdc	85 W	90%	0.99	0.95	EUC-085S105DV(SV)(4)
1400 mA	90 ~ 305 Vac	30~61 Vdc	85 W	90%	0.99	0.95	EUC-085S140DV(SV)(4)
1750 mA	90 ~ 305 Vac	24~49 Vdc	85 W	90%	0.99	0.95	EUC-085S175DV(SV)(4)
2000 mA	90 ~ 305 Vac	21~43 Vdc	85 W	90%	0.99	0.95	EUC-085S200DV(SV)(4)
2450 mA	90 ~ 305 Vac	17~35 Vdc	85 W	89%	0.99	0.95	EUC-085S245DV(SV)(4)
2800 mA	90 ~ 305 Vac	15~30 Vdc	85 W	89%	0.99	0.95	EUC-085S280DV(SV)(4)

**Notes:** (1) Measured at full load and 220 Vac input.

(2) The DV suffix may be changed to SV to omit the dimming function and remove the two wires associated with that function.

(3) All the models are certificated to KS, except EUC-085S035DV(SV)

(4) SELV Output

## Input Specifications

Parameter	Min.	Typ.	Max.	Notes
Input Voltage	90 Vac	-	305 Vac	
Input Frequency	47 Hz	-	63 Hz	
Leakage Current	-	-	0.75 mA	At 277Vac 60Hz input

## Input Specifications (Continued)

Parameter	Min.	Typ.	Max.	Notes
Input AC Current	-	-	1.1 A	Measured at full load and 100 Vac input.
	-	-	0.5 A	Measured at full load and 220 Vac input.
Inrush Current	-	-	60 A	At 220Vac input, 25°C cold start, duration=1 ms, 10%l <sub>pk</sub> -10%l <sub>pk</sub> .
Inrush Current(I <sup>2</sup> t)	-	-	1 A <sup>2</sup> s	
Power Factor	0.90	-	-	At 100Vac-277Vac,100% Load
THD	-	-	20%	

## Output Specifications

Parameter	Min.	Typ.	Max.	Notes
Output Current Range	-5%	-	5%	
Ripple and Noise (pk-pk)	-	-	3% V <sub>O</sub>	Measured by 20 MHz bandwidth oscilloscope and the output paralleled a 0.1 uF ceramic capacitor and a 10 uF electrolytic capacitor.
Output Current Ripple at < 200 Hz (pk-pk)	-	1%I <sub>O</sub>	-	At full load condition. Only this component of ripple is associated with visible flicker.
Output Overshoot / Undershoot	-	-	10%	When power on or off.
No-load Output Voltage				
I <sub>O</sub> = 350 mA	-	-	255V	
I <sub>O</sub> = 450 mA	-	-	198V	
I <sub>O</sub> = 700 mA	-	-	129V	
I <sub>O</sub> = 1050 mA	-	-	87V	
I <sub>O</sub> = 1400 mA	-	-	67V	
I <sub>O</sub> = 1750 mA	-	-	54V	
I <sub>O</sub> = 2000 mA	-	-	48V	
I <sub>O</sub> = 2450 mA	-	-	39V	
I <sub>O</sub> = 2800 mA	-	-	33V	
Line Regulation	-	-	±2%	
Load Regulation	-	-	±3%	
Turn-on Delay Time	-	2.0 s	3.0 s	Measured at 120Vac input.
	-	0.6 s	1.0 s	Measured at 220Vac input.
Temperature Coefficient	-	-	0.06%/°C	Case temperature = 0°C ~T <sub>c</sub> max

**Note:** All specifications are typical at 25 °C unless otherwise stated.

## Protection Functions

Parameter	Min.	Typ.	Max.	Notes
Over Temperature Protection-T <sub>c</sub>	-	100 °C	-	Latch mode. The power supply shall return to normal operation only after the power is turn-on again.
Short Circuit Protection	No damage shall occur when any output operating in a short circuit condition. The power supply shall be self-recovery when the fault condition is removed.			

## General Specifications

Parameter	Min.	Typ.	Max.	Notes
Efficiency $I_o = 350 \text{ mA}$ $I_o = 450 \text{ mA}$ $I_o = 700 \text{ mA}$ $I_o = 1050 \text{ mA}$ $I_o = 1400 \text{ mA}$ $I_o = 1750 \text{ mA}$ $I_o = 2000 \text{ mA}$ $I_o = 2450 \text{ mA}$ $I_o = 2800 \text{ mA}$	88% 88% 87% 87% 87% 87% 87% 86% 86%	89% 89% 88% 88% 88% 88% 88% 87% 87%	- - - - - - - - -	Measured at full load, 120Vac input, 25°C ambient temperature, after the unit is thermally stabilized. It will be lower about 2%, if measured immediately after startup.
Efficiency $I_o = 350 \text{ mA}$ $I_o = 450 \text{ mA}$ $I_o = 700 \text{ mA}$ $I_o = 1050 \text{ mA}$ $I_o = 1400 \text{ mA}$ $I_o = 1750 \text{ mA}$ $I_o = 2000 \text{ mA}$ $I_o = 2450 \text{ mA}$ $I_o = 2800 \text{ mA}$	90% 90% 89% 89% 89% 89% 89% 88% 88%	91% 91% 90% 90% 90% 90% 90% 89% 89%	- - - - - - - - -	Measured at full load, 220Vac input, 25°C ambient temperature, after the unit is thermally stabilized. It will be lower about 2%, if measured immediately after startup.
MTBF	-	237,000 hours	-	Measured at 120Vac input, 80%Load and 25°C ambient temperature (MIL-HDBK-217F)
Lifetime	-	101,000 hours	-	Measured at 120Vac input, 80%Load ; Case temperature=60°C @ Tc point. See life time vs. Tc curve for the details
Operating Case Temperature for Safety Tc_s	-40 °C	-	+90 °C	
Operating Case Temperature for Warranty Tc_w	-40 °C	-	+70 °C	
Storage Temperature	-40 °C	-	+85 °C	Humidity: 5% RH to 100% RH
Dimensions Inches (L x W x H) Millimeters (L x W x H)	5.91 x 2.66 x 1.44 150 x 67.5 x 36.5			With mounting ear 6.97 x 2.66 x 1.44 177 x 67.5 x 36.5
Net Weight	-	780 g	-	

**Note:** All specifications are typical at 25 °C unless otherwise stated.

## Safety & EMC Compliance

Safety Category	Standard
CE	EN61347-1, EN61347-2-13
KS	KS C 7655 : 2011
EMI Standards	Notes
EN 55015 <sup>(1)</sup>	Conducted emission Test & Radiated emission Test
EN 61000-3-2	Harmonic current emissions
EN 61000-3-3	Voltage fluctuations & flicker

## Safety & EMC Compliance (Continued)

EMS Standards	Notes
EN 61000-4-2	Electrostatic Discharge (ESD): 8 kV air discharge, 4 kV contact discharge
EN 61000-4-3	Radio-Frequency Electromagnetic Field Susceptibility Test-RS
EN 61000-4-4	Electrical Fast Transient / Burst-EFT
EN 61000-4-5	Surge Immunity Test: AC Power Line: line to line 4 kV, line to earth 6 kV
EN 61000-4-6	Conducted Radio Frequency Disturbances Test-CS
EN 61000-4-8	Power Frequency Magnetic Field Test
EN 61000-4-11	Voltage Dips
EN 61547	Electromagnetic Immunity Requirements Applies to Lighting Equipment

**Note:** (1) This LED driver meets the EMI specifications above, but EMI performance of a luminaire that contains it depends also on the other devices connected to the driver and on the fixture itself.

## Derating Curve

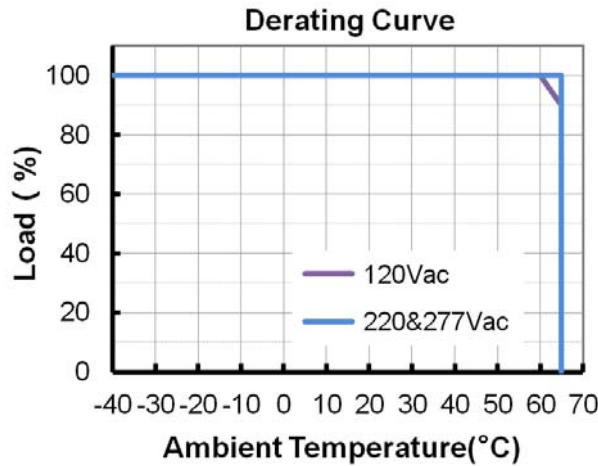

## Lifetime vs. Case Temperature Curve

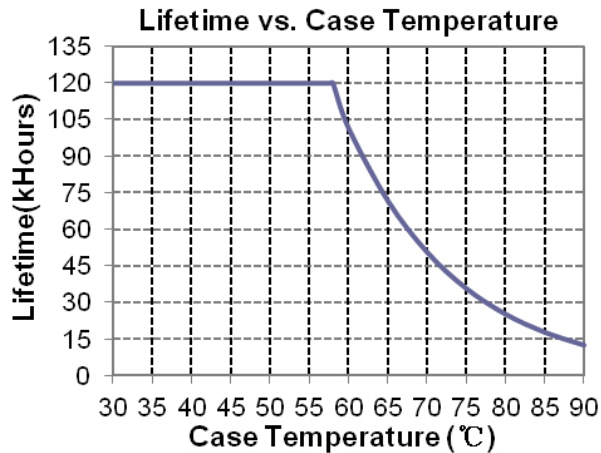

## Efficiency vs. Load

EUC-085S035DV(SV)

Efficiency vs. Output Voltage

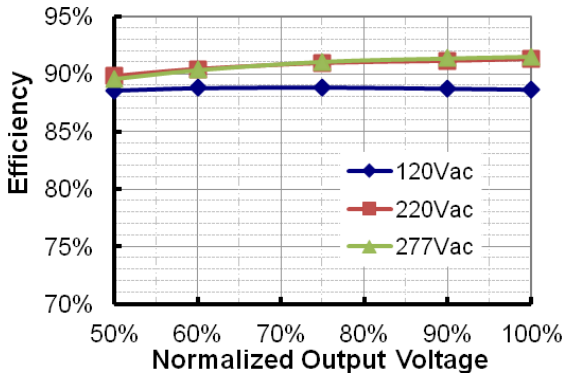

EUC-085S045DV(SV)

Efficiency vs. Output Voltage

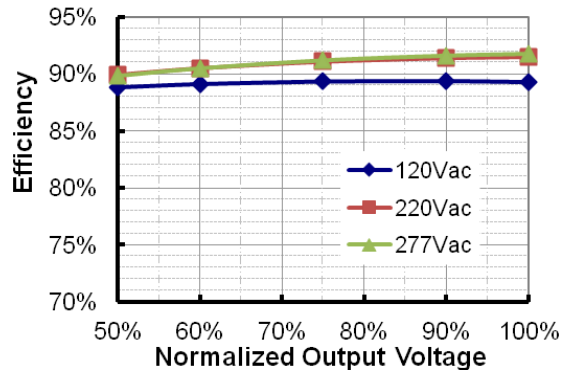

EUC-085S070DV(SV)

Efficiency vs. Output Voltage

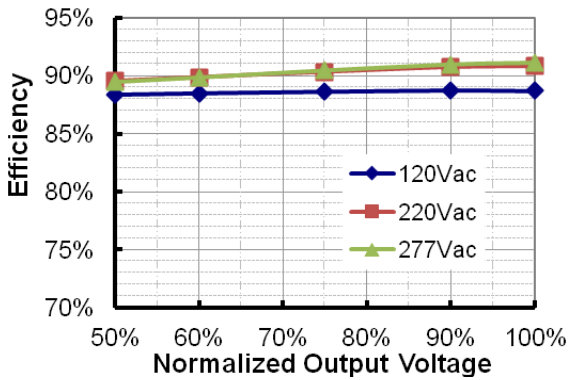

EUC-085S105DV(SV)

Efficiency vs. Output Voltage

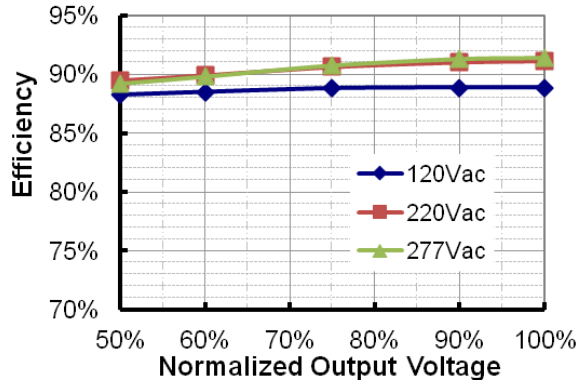

EUC-085S140DV(SV)

Efficiency vs. Output Voltage

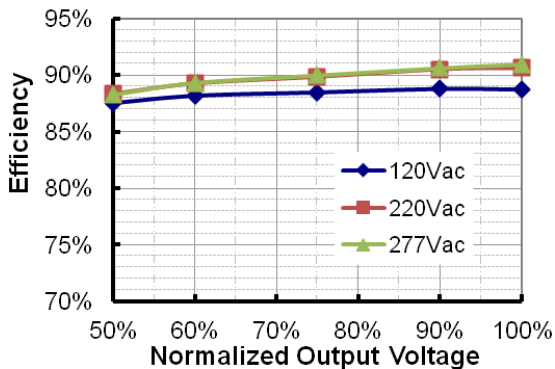

EUC-085S175DV(SV)

Efficiency vs. Output Voltage

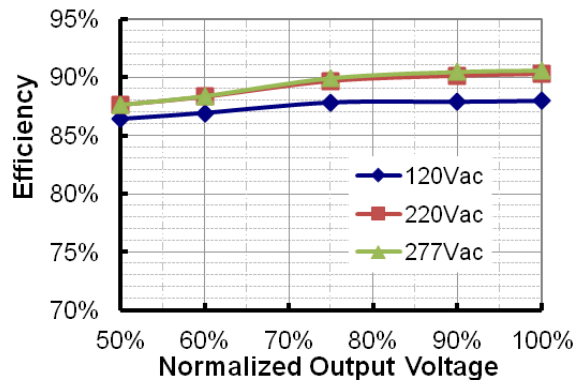

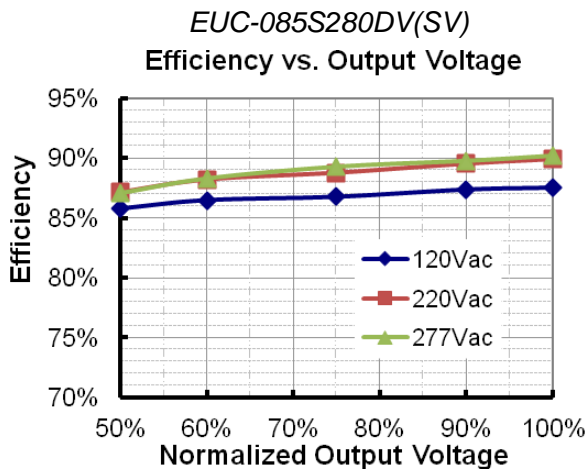
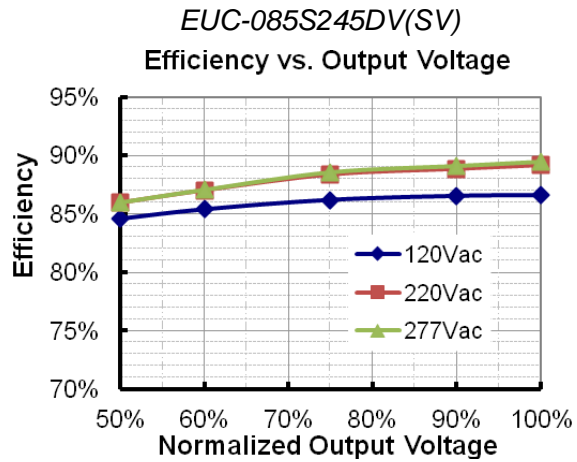
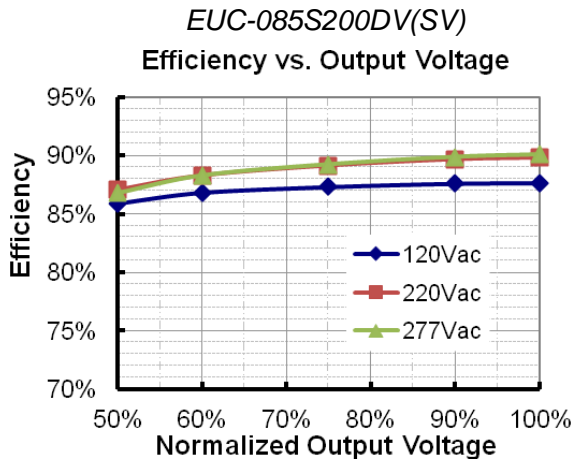

### Dimming Control (On secondary side)

Parameter	Min.	Typ.	Max.	Notes
Absolute maximum voltage on 1-10V input pin	-2 V	-	12 V	
Source current on 1~10V input pin	0 mA	-	0.5 mA	

The dimmer control may be operated from either a potentiometer or from an input signal of 1 – 10 Vdc. Two recommended implementations are provided below.

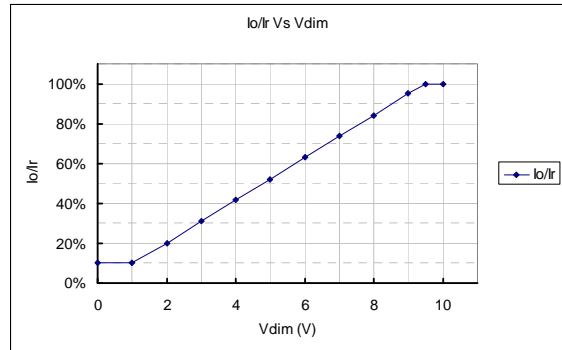
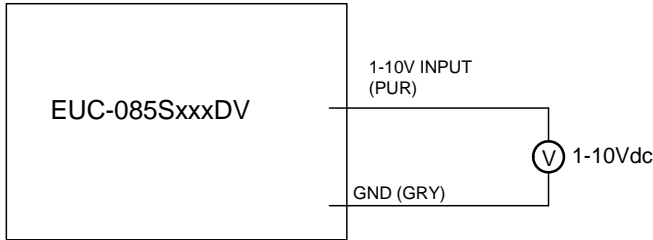

Implementation 1: DC input

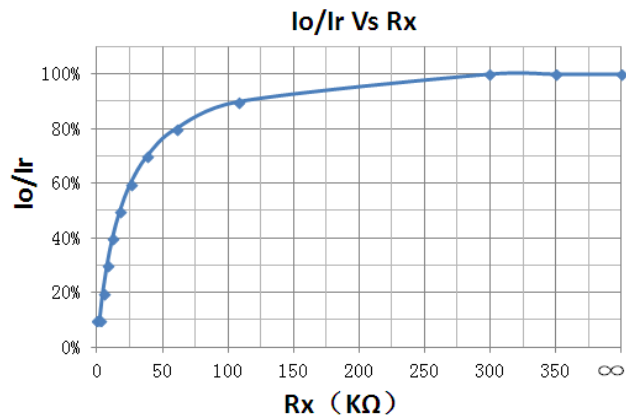
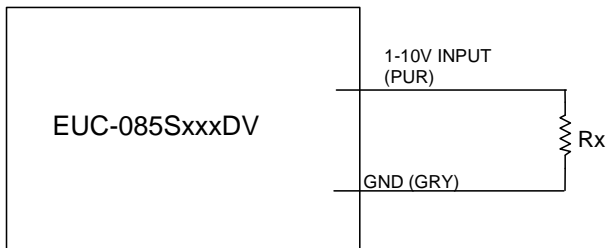

Implementation 2: External resistor

**Notes:**

1. Io is actual output current and Ir is rated current without dimming control.
2. For the driver to operate properly, the load voltage must be maintained above the minimum voltage threshold (approx. 50% of the max. output voltage for any given model).
3. If the output voltage is maintained above 50% of the maximum output voltage, the dimming control may be operated over the entire 1-10V range with output current varying from 100% down to practically 10%.
4. The dimming signal is allowed to be less than 1V, however, when it for 0-1V, the output current is 10%Io.
5. Do not connect the GND of dimming to the output; otherwise, the LED driver can not work normally.

## Mechanical Outline

### EUC-085SxxxDV (Old Product)

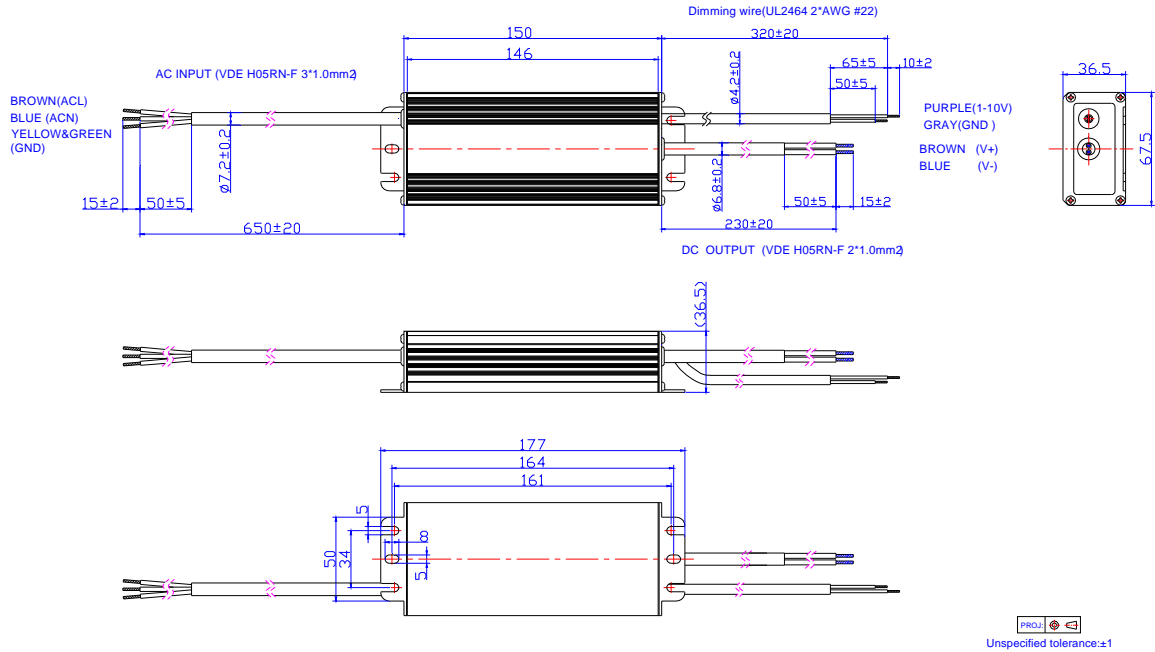

### EUC-085SxxxDV (New Product)

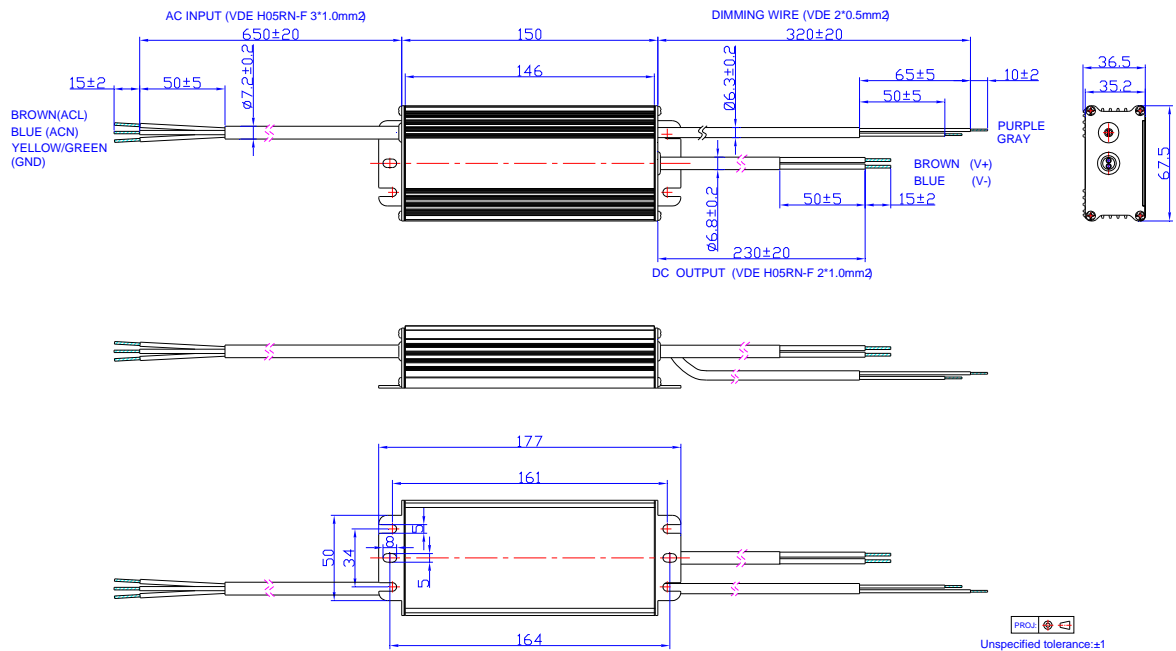



EUC-085SxxxSV

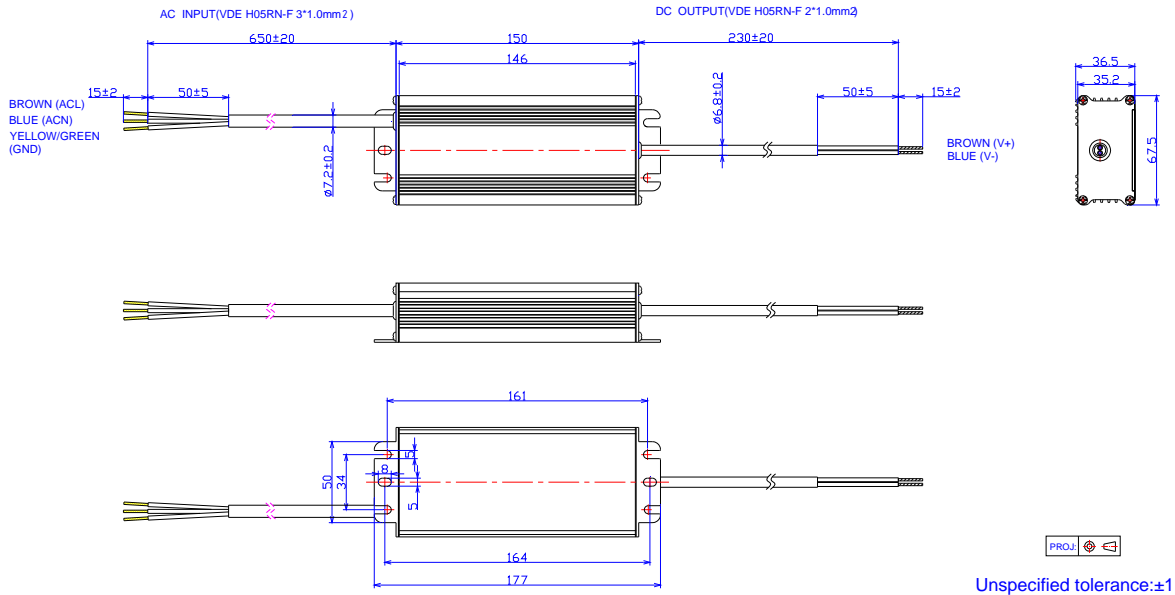

## RoHS Compliance

Our products comply with the European Directive 2011/65/EC, calling for the elimination of lead and other hazardous substances from electronic products.

## Revision History

Change Date	Rev.	Description of Change		
		Item	From	To
2010-09-01	A	Add EUC-085SxxxST Series	EUC-085SxxxDT	EUC-085SxxxST/DT
		Add notes of UL1310 Class 2 for all models.	/	(4) (5) (6)
		Add No-load Output Voltage	/	The typ. value of every model.
		Change Ripple and Noise (pk-pk)	5% V <sub>O</sub>	1% V <sub>O</sub>
		Change Line Regulation	1%	2%
		Change efficiency for all models	/	/
		Change MTBF	498,000 hours	300,000 hours
		Change Life Time	90,000 hours	63,000 hours
		Change Net Weight	750 g	770 g
		Delete the Dimming Implementation-- External zener diodes	Implementation 2: External zener diodes	/
		Change Mechanical Outline The dimming control Wire The output Wire	Purple / Green Red / Black	Purple / Gray Red / Blue

2010-9-29	B	Change Output Voltage Range I <sub>o</sub> = 350 mA I <sub>o</sub> = 450 mA I <sub>o</sub> = 700 mA I <sub>o</sub> = 1050 mA I <sub>o</sub> = 1400 mA I <sub>o</sub> = 1750 mA I <sub>o</sub> = 2000 mA I <sub>o</sub> = 2450 mA I <sub>o</sub> = 2800 mA	Min. 121 V 94 V 61 V 40 V 30 V 24 V 21 V 17 V 15 V	Min. 122 V 95 V 61 V 41 V 31 V 25 V 22 V 18 V 16 V
		Change Ripple and Noise (pk-pk)	Max. 1% Vo	Max. 3% Vo
2010-11-17	C	Add Derating Curve	/	/
2012-02-23	D	Mechanical Outline	the position of the wire outing hole	Changed
		OTP	120°C	110°C
2012-06-19	E	Life time curve	/	Added
		EN61000-4-5	line to line 2 kV, line to earth 4 kV	line to line 4 kV, line to earth 6 kV
		Max of No-load Output Voltage	/	Added
2012-7-5	F	Inrush Current	50 A	60 A
2012-7-17	G	Max Case Temperature	/	Updated
2012-9-27	H	Min PF, Max THD	/	Added
		Temperature coefficient	/	Added
		MTBF, Life time Typical Value	/	Added
		Life Time Curve	/	Updated
		Operating Temperature	-35°C	-40°C
		Derating Curve	/	Updated
2013-06-06	I	Product photo	/	Updated
		Min Output Voltage	/	Corrected
		Leakage current	1mA	0.75mA
		Typical value of OTP	110°C	100°C
		MTBF	320,000 hours	237,000 hours
		Derating Curve	/	Updated
		Efficiency curve	/	Added
		Mechanical outline	/	Updated
2016-04-20	J	CCC, KS	/	Added
		Features	/	Updated
		Description	/	Updated
		Models	/	Updated
		Output Specifications	Output Current Ripple at < 200 Hz (pk-pk)	Added
		General Specifications	Case Temperature	Operating Case Temperature for Safety T <sub>c_s</sub>
		General Specifications	Operating Case	Added

			Temperature for Warranty Tc_w	
		General Specifications	Storage Temperature	Added
		General Specifications	With mounting ear	Added
		General Specifications	Net Weight	Updated
		Environmental Specifications	/	Delete
		Safety & EMC Compliance	/	Updated
		Mechanical Outline	/	Updated