

## Features

- High Efficiency (Up to 91.0%)
- Full Power at Wide Output Current Range (Constant Power)
- Adjustable Output Current (AOC) with Dip-switch
- Non-dimming Control
- Input Surge Protection: 6 kV line-line, 10 kV line-earth
- All-Around Protection: OVP, SCP, OTP
- Waterproof (IP67) and UL Dry / Damp / Wet Location
- Class 2 & SELV Output
- TYPE HL, for use in a Class I, Division 2 hazardous (Classified) location



## Description

The EUP-075SxxxST series is a 75W, constant-current, AOC LED driver that operates from 90-305 Vac input with excellent power factor. It is created for street, tunnel and bay lights. The high efficiency of these drivers and compact metal case enables them to run cooler, significantly improving reliability and extending product life. To ensure trouble-free operation, protection is provided against input surge, output over voltage, short circuit, and over temperature.

## Models

Adjustable Output Current Range	Full-Power Current Range (1)	Default Output Current	Input Voltage Range(2)	Output Voltage Range	Max. Output Power	Typical Efficiency (3)	Power Factor		Model Number
							120Vac	220Vac	
350-700mA	450-700mA	550 mA	90~305 Vac/ 127~300 Vdc	54~167Vdc	75 W	91.0%	0.98	0.96	EUP-075S070ST
700-1050mA	700-1050mA	700 mA	90~305 Vac/ 127~300 Vdc	36~107Vdc	75 W	91.0%	0.98	0.96	EUP-075S105ST <sup>(4)</sup>
1050-1750mA	1190-1750mA	1400 mA	90~305 Vac/ 127~300 Vdc	22 ~ 63Vdc	75 W	90.5%	0.98	0.96	EUP-075S175ST <sup>(4)</sup>
1700-2800mA	1900-2800mA	2100 mA	90~305 Vac/ 127~300 Vdc	14 ~ 39Vdc	75 W	89.5%	0.98	0.96	EUP-075S280ST <sup>(5)</sup>

- Notes:** (1) Output current range with constant power at 75W  
 (2) UL, FCC certified input voltage range: 100-277Vac or 127-300Vdc; other certified input voltage range except UL & FCC: 100-240Vac or 127-250Vdc (except KS)  
 (3) Measured at full load and 220Vac input (see below "General Specifications" for details).  
 (4) SELV Output.  
 (5) Class 2 & SELV Output.

## Input Specifications

Parameter	Min.	Typ.	Max.	Notes
Input Voltage	90 Vac	-	305 Vac	127~300 Vdc
Input Frequency	47 Hz	-	63 Hz	
Leakage Current	-	-	0.75 MIU	UL8750; 277Vac/ 60Hz
	-	-	0.70 mA	IEC60598-1; 240Vac/ 60Hz

## Input Specifications (Continued)

Parameter	Min.	Typ.	Max.	Notes
Input AC Current	-	-	1.05 A	Measured at full load and 100 Vac input.
	-	-	0.45 A	Measured at full load and 220 Vac input.
Inrush Current(I <sup>2</sup> t)	-	-	0.54 A <sup>2</sup> s	At 220Vac input, 25°C cold start, duration=164 us, 10%lpk-10%lpk. See Inrush Current Waveform for the details.
PF	0.9	-	-	At 100-277Vac, 75%-100% Load (56-75W)
THD	-	-	20%	
THD	-	8%	-	At 220-240Vac, 50-60Hz, 80%-100%Load Please evaluate with LEDs to insure THD<10%.

## Output Specifications

Parameter	Min.	Typ.	Max.	Notes
Output Current Tolerance	-5%loset	-	5%loset	At full load condition
Output Current Setting(loset) Range				
EUP-075S070ST	350 mA	-	700 mA	
EUP-075S105ST	700 mA	-	1050 mA	
EUP-075S175ST	1050 mA	-	1750 mA	
EUP-075S280ST	1700 mA	-	2800 mA	
Output Current Setting Range with Constant Power				
EUP-075S070ST	450 mA	-	700 mA	
EUP-075S105ST	700 mA	-	1050 mA	
EUP-075S175ST	1190 mA	-	1750 mA	
EUP-075S280ST	1900 mA	-	2800 mA	
Total Output Current Ripple (pk-avg)	-	50%lomax	100%lomax	At full load condition. 20 MHz BW
Startup Overshoot Current	-	-	10%lomax	At full load condition
No Load Output Voltage				
EUP-075S070ST	-	-	200 V	
EUP-075S105ST	-	-	119 V	
EUP-075S175ST	-	-	78 V	
EUP-075S280ST	-	-	59 V	
Line Regulation	-	-	±0.5%	Measured at full load
Load Regulation	-	-	±1.5%	
Turn-on Delay Time	-	-	1.0 s	Measured at 120Vac input, 75%-100% Load
	-	-	0.5 s	Measured at 220Vac input, 75%-100% Load
Temperature Coefficient of loset	-	0.03%/°C	-	Case temperature = 0°C ~Tc max

**Note:** All specifications are typical at 25°C unless otherwise stated.

## General Specifications

Parameter	Min.	Typ.	Max.	Notes
Efficiency at 120 Vac input: EUP-075S070ST Io= 450 mA Io= 700 mA EUP-075S105ST Io= 700 mA Io=1050 mA EUP-075S175ST Io=1190 mA Io=1750 mA EUP-075S280ST Io=1900 mA Io=2800 mA	87.0% 86.0% 87.5% 86.0% 86.5% 84.5% 85.0% 83.0%	89.0% 88.0% 89.5% 88.0% 88.5% 86.5% 87.0% 85.0%	- - - - - - - -	Measured at full load and steady-state temperature in 25°C ambient; (Efficiency will be about 2.0% lower if measured immediately after startup.)
Efficiency at 220 Vac input: EUP-075S070ST Io= 450 mA Io= 700 mA EUP-075S105ST Io= 700 mA Io=1050 mA EUP-075S175ST Io=1190 mA Io=1750 mA EUP-075S280ST Io=1900 mA Io=2800 mA	89.0% 88.5% 89.0% 88.0% 88.5% 86.5% 87.5% 85.0%	91.0% 90.5% 91.0% 90.0% 90.5% 88.5% 89.5% 87.0%	- - - - - - - -	Measured at full load and steady-state temperature in 25°C ambient; (Efficiency will be about 2.0% lower if measured immediately after startup.)
Efficiency at 277 Vac input: EUP-075S070ST Io= 450 mA Io= 700 mA EUP-075S105ST Io= 700 mA Io=1050 mA EUP-075S175ST Io=1190 mA Io=1750 mA EUP-075S280ST Io=1900 mA Io=2800 mA	88.5% 88.5% 89.0% 88.5% 88.5% 87.0% 87.5% 85.5%	90.5% 90.5% 91.0% 90.5% 90.5% 89.0% 89.5% 87.5%	- - - - - - - -	Measured at full load and steady-state temperature in 25°C ambient; (Efficiency will be about 2.0% lower if measured immediately after startup.)
MTBF	-	548,000 Hours	-	Measured at 220Vac input, 80%Load and 25°C ambient temperature (MIL-HDBK-217F)
Lifetime	-	79,000 Hours	-	Measured at 220Vac input, 80%Load and 70°C case temperature; See lifetime vs. Tc curve for the details
Operating Case Temperature for Safety Tc_s	-40°C	-	+88°C	
Operating Case Temperature for Warranty Tc_w	-40°C	-	+75°C	
Storage Temperature	-40°C	-	+85°C	Humidity: 5%RH to 100%RH
Dimensions Inches (L x W x H) Millimeters (L x W x H)	5.71 x 2.37 x 1.44 145 x 60 x 36.5			With mounting ear 6.54 x 2.37 x 1.44 166 x 60 x 36.5
Net Weight	-	650 g	-	

**Note:** All specifications are typical at 25°C unless otherwise stated.

## Safety & EMC Compliance

Safety Category	Standard
UL/CUL	UL 8750, UL 1310, CAN/CSA-C22.2 No. 250.13, CAN/CSA-C22.2 No. 223-M91
CE	EN 61347-1, EN61347-2-13
KS	KS C 7655
EMI Standards	Notes
EN 55015 <sup>(1)</sup>	Conducted emission Test & Radiated emission Test
EN 61000-3-2	Harmonic current emissions
EN 61000-3-3	Voltage fluctuations & flicker
FCC Part 15 <sup>(1)</sup>	ANSI C63.4 Class B
	This device complies with Part 15 of the FCC Rules. Operation is subject to the following two conditions: [1] this device may not cause harmful interference, and [2] this device must accept any interference received, including interference that may cause undesired Operation.
EMS Standards	Notes
EN 61000-4-2	Electrostatic Discharge (ESD): 8 kV air discharge, 4 kV contact discharge
EN 61000-4-3	Radio-Frequency Electromagnetic Field Susceptibility Test-RS
EN 61000-4-4	Electrical Fast Transient / Burst-EFT
EN 61000-4-5	Surge Immunity Test: AC Power Line: line to line 6 kV, line to earth 10 kV <sup>(2)</sup>
EN 61000-4-6	Conducted Radio Frequency Disturbances Test-CS
EN 61000-4-8	Power Frequency Magnetic Field Test
EN 61000-4-11	Voltage Dips
EN 61547	Electromagnetic Immunity Requirements Applies To Lighting Equipment

**Note:** (1) This LED driver meets the EMI specifications above, but EMI performance of a luminaire that contains it depends also on the other devices connected to the driver and on the fixture itself.

(2) To perform electric strength (hi-pot) testing, the "GDT ground disconnect" (nut and metal lock sheet) on the driver end-cap should be removed temporarily to prevent the internal gas discharge tube from conducting (as allowed by IEC 60598-1 Clause 10.2). After testing is completed, these items must be reinstalled to restore line-to-earth surge protection and secure the end cap.

## Derating

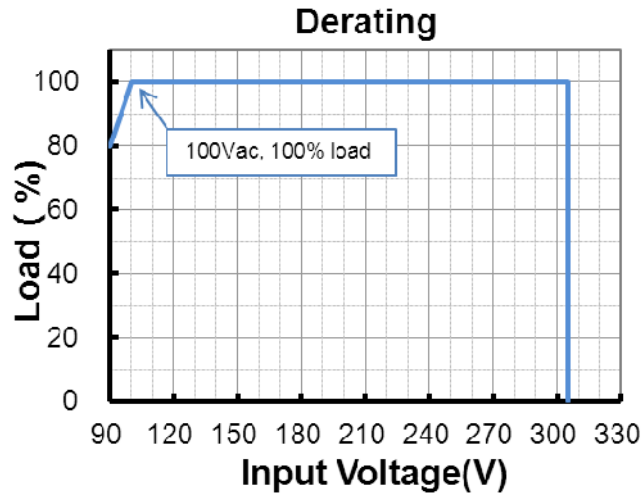

## Lifetime vs. Case Temperature

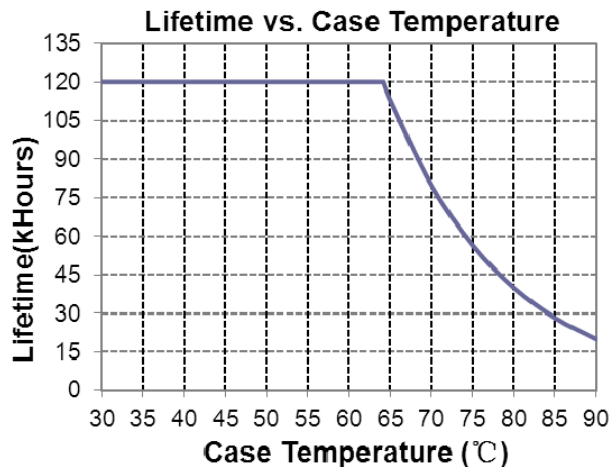

## Inrush Current Waveform

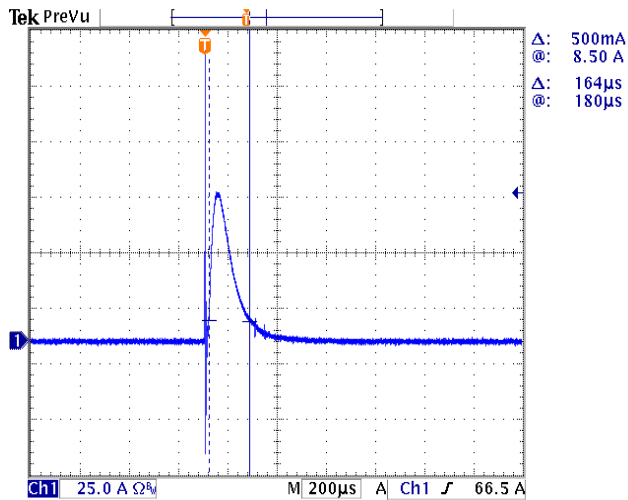

## Efficiency vs. Load

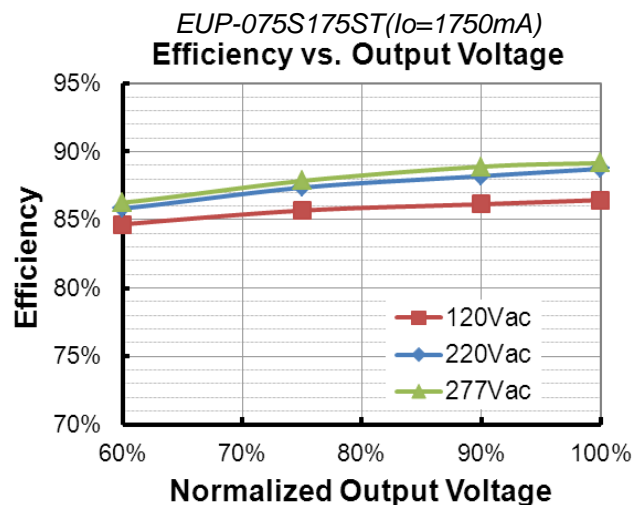
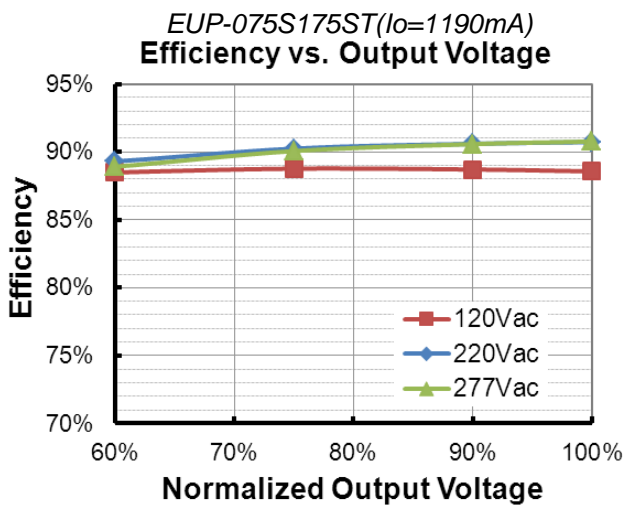
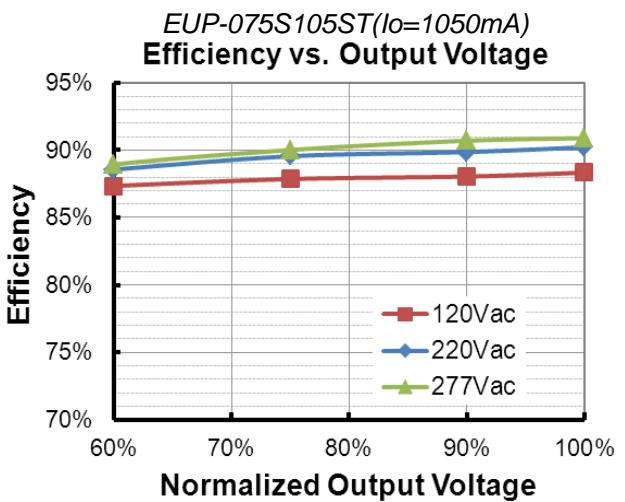
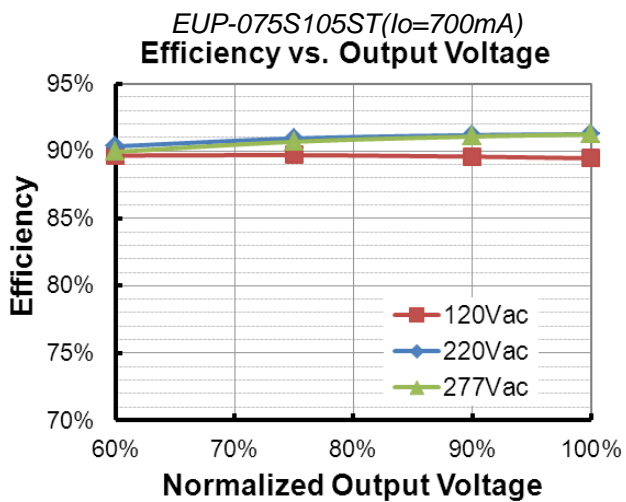
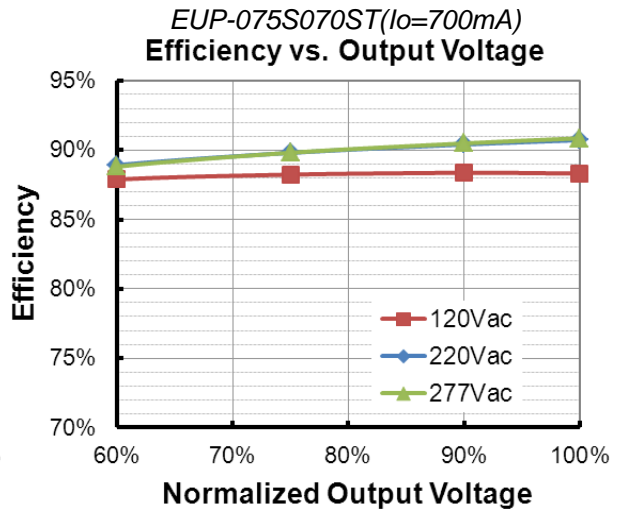
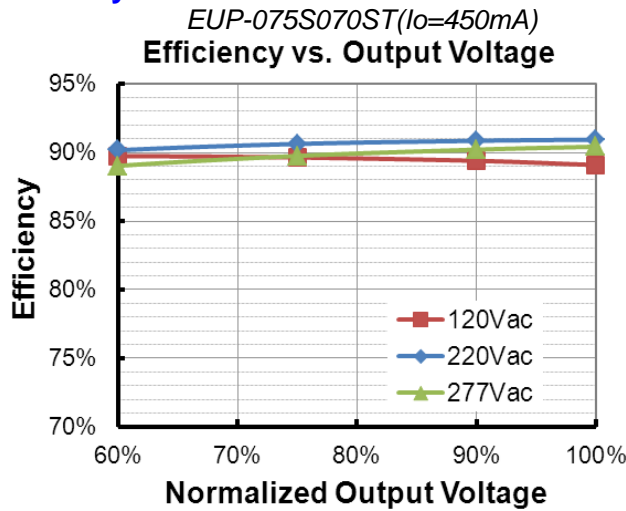

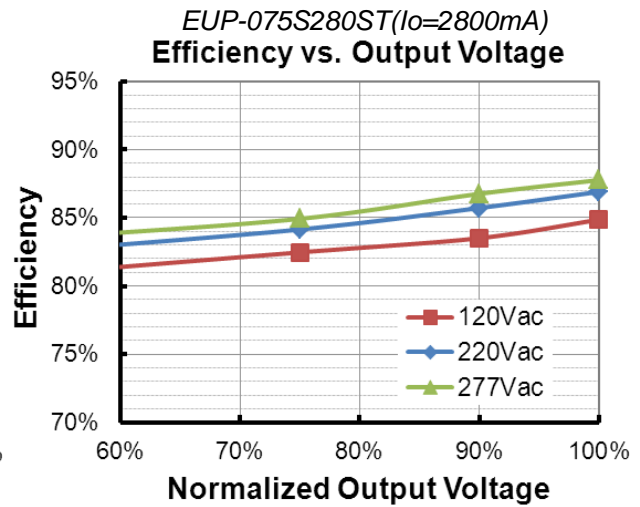
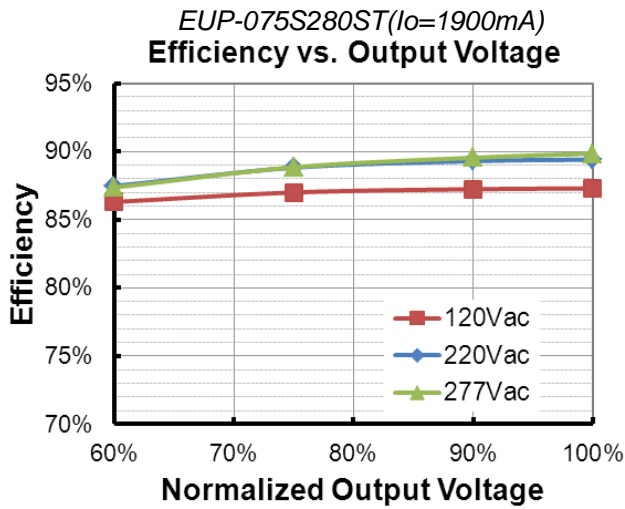

## Power Factor

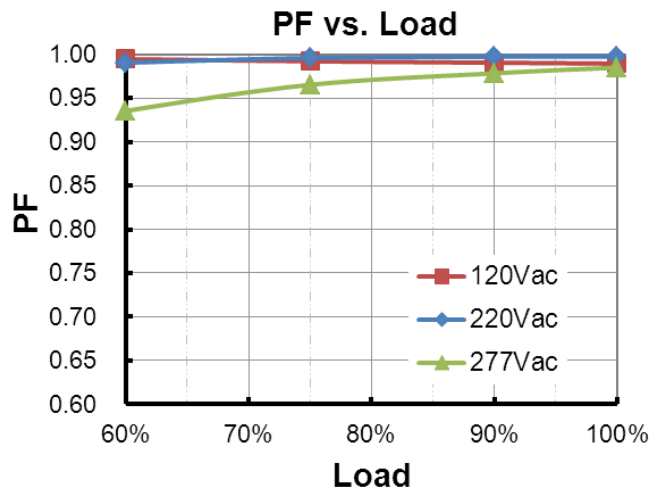

## Total Harmonic Distortion (Based on Cree XP-G2 LEDs)

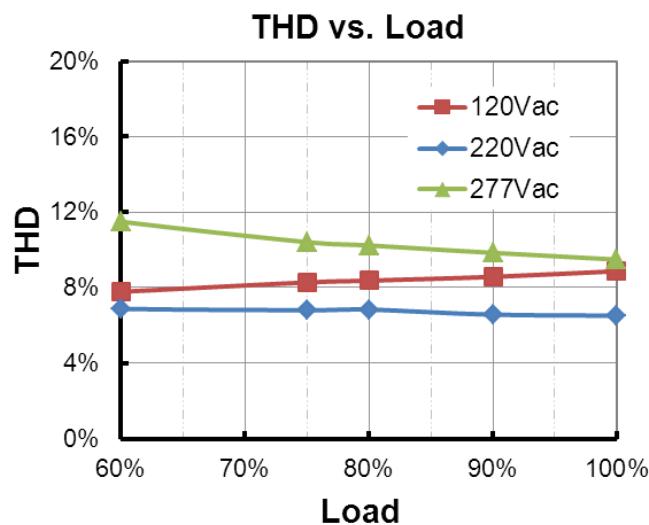



## Protection Functions

Parameter	Notes
Over Temperature Protection	Decreases output current, returning to normal after over temperature is removed.
Short Circuit Protection	Auto Recovery. No damage will occur when any output is short circuited. The output shall return to normal when the fault condition is removed.
Over Voltage Protection	Limits output voltage at no load and in case the normal voltage limit fails.

## Output Current vs. Dip-Switch Setting

### ● EUP-075S070ST

Dip Switch Setting				Output Current Setting(loset)	Output Voltage Range		Notes
1	2	3	4	Typ.	Min.	Max.	/
OFF	ON	ON	ON	700mA	54V	107V	Output Current Setting with Constant Power.
OFF	ON	ON	OFF	650mA	58V	115V	
OFF	ON	OFF	ON	600mA	63V	125V	
OFF	ON	OFF	OFF	550mA	68V	136V	
OFF	OFF	ON	ON	500mA	75V	150V	
OFF	OFF	ON	OFF	450mA	84V	167V	
OFF	OFF	OFF	ON	400mA	94V	167V	Output Current Setting with Power Derating.
OFF	OFF	OFF	OFF	350mA	107V	167V	

### ● EUP-075S105ST

Dip Switch Setting				Output Current Setting(loset)	Output Voltage Range		Notes
1	2	3	4	Typ.	Min.	Max.	/
ON	ON	ON	ON	1050mA	36V	71V	Output Current Setting with Constant Power.
ON	ON	ON	OFF	1000mA	38V	75V	
ON	ON	OFF	ON	950mA	40V	79V	
ON	ON	OFF	OFF	900mA	42V	83V	
ON	OFF	ON	ON	850mA	44V	88V	
ON	OFF	ON	OFF	800mA	47V	93V	
ON	OFF	OFF	ON	750mA	50V	100V	
ON	OFF	OFF	OFF	700mA	54V	107V	



● EUP-075S175ST

Dip Switch Setting				Output Current Setting(loset)	Output Voltage Range		Notes
1	2	3	4	Typ.	Min.	Max.	/
ON	ON	ON	ON	1750mA	22V	42.5V	Output Current Setting with Constant Power.
ON	ON	ON	OFF	1680mA	23V	44.5V	
ON	ON	OFF	ON	1610mA	24V	46.5V	
ON	ON	OFF	OFF	1540mA	25V	48.5V	
ON	OFF	ON	ON	1470mA	26V	51V	
ON	OFF	ON	OFF	1400mA	27V	53.5V	
ON	OFF	OFF	ON	1330mA	28V	56V	
ON	OFF	OFF	OFF	1260mA	30V	59.5V	
OFF	ON	ON	ON	1190mA	32V	63V	
OFF	ON	ON	OFF	1120mA	34V	63V	Output Current Setting with Power Derating.
OFF	ON	OFF	ON	1050mA	36V	63V	

● EUP-075S280ST

Dip Switch Setting				Output Current Setting(loset)	Output Voltage Range		Notes
1	2	3	4	Typ.	Min.	Max.	/
ON	ON	ON	ON	2800mA	14V	26.5V	Output Current Setting with Constant Power.
ON	ON	ON	OFF	2700mA	14V	27.5V	
ON	ON	OFF	ON	2600mA	15V	28.5V	
ON	ON	OFF	OFF	2500mA	15V	30V	
ON	OFF	ON	ON	2400mA	16V	31V	
ON	OFF	ON	OFF	2300mA	17V	32.5V	
ON	OFF	OFF	ON	2200mA	17V	34V	
ON	OFF	OFF	OFF	2100mA	18V	35.5V	
OFF	ON	ON	ON	2000mA	19V	37.5V	
OFF	ON	ON	OFF	1900mA	20V	39V	Output Current Setting with Power Derating.
OFF	ON	OFF	ON	1800mA	21V	39V	
OFF	ON	OFF	OFF	1700mA	22V	39V	

**Notes:**

1. Dip switch must be set in the setting range as specified to insure the driver operates as expected.
2. Endcap covering dip switch must be tight to insure IP67 rating.

**Mechanical Outline**

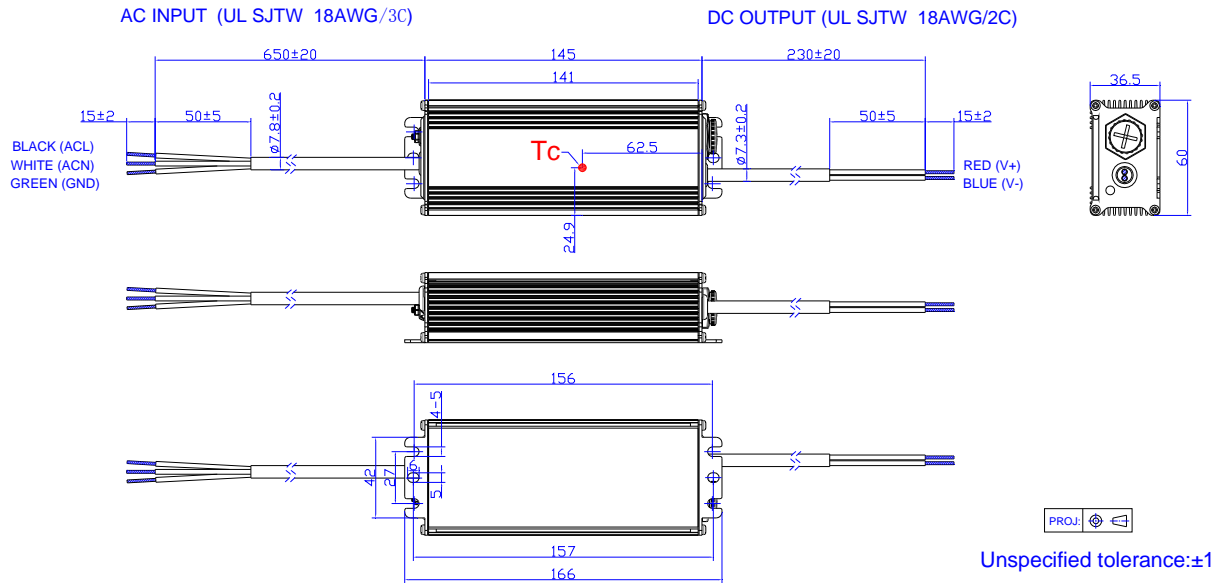

**RoHS Compliance**

Our products comply with the European Directive 2011/65/EC, calling for the elimination of lead and other hazardous substances from electronic products.

## Revision History

Change Date	Rev.	Description of Change		
		Item	From	To
2016-08-10	A	Datasheets Release	/	/
2016-08-30	B	Models	Adjustable Output Current Range	Updated
		Output Specifications	Output Current Setting(loset) Range	Updated
		Output Current vs. Dip Switch Setting	/	Updated
2017-06-02	C	Output Specifications	Total Output Current Ripple (pk-pk)	Total Output Current Ripple (pk-avg)
		Output Specifications	Temperature Coefficient of loset	Updated
		Safety &EMC Compliance	/	Updated