

## Features

- High Efficiency (Up to 90.5%)
- Isolated 0-10V Dimmable(DVA models)  
Non-Dimmable (SVA models)
- Deep Dimming down to 0.1%
- Constant Voltage PWM Output Frequency up to 1.5kHz
- Dim-to-Off with Standby Power  $\leq 0.5$  W
- Input Surge Protection: 4kV line-line, 6kV line-earth
- All-Around Protection: OCP, OVP, SCP, OTP
- Waterproof (IP67)
- SELV Output
- Suitable for Independent Use
- 5 Years Warranty

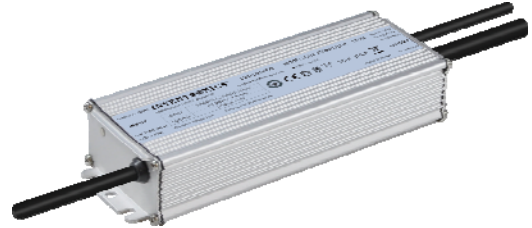

## Description

The EUV-150SxxxDVA(SVA) series is a 150W, constant-voltage IP67 LED driver that operates from 90-305 Vac input with excellent power factor. It is created for many lighting applications including LED strip, architectural, decorative and signage. The high efficiency of the driver and compact metal case enables them to run cooler, significantly improving reliability and extending product life. To ensure trouble-free operation, protection is provided against input surge, over current, output over voltage, over temperature, and short circuit.

## Models

Output Voltage	Input Voltage Range (1)	Output Current Range	Max. Output Power	Typical Efficiency (2)	Power Factor		Model Number(3)
					120Vac	220Vac	
12 V	90~305 Vac 127~250 Vdc	0 ~ 12.5 A	150 W	90.0%	0.99	0.96	EUV-150S012DVA(SVA)
24 V	90~305 Vac 127~250 Vdc	0 ~ 6.25 A	150 W	90.5%	0.99	0.96	EUV-150S024DVA(SVA)

- Notes:** (1) Certified input Voltage range: 100-240Vac or 127-250Vdc (except CCC and KS).  
 (2) Measured at 100% load and 220Vac input (see below "General Specifications" for details).  
 (3) SELV output.

## Input Specifications

Parameter	Min.	Typ.	Max.	Notes
Input Voltage	90 Vac	-	305 Vac	127~250Vdc
Input Frequency	47 Hz	-	63 Hz	
Leakage Current	-	-	0.70 mA	IEC60598-1; 240Vac/60Hz
Input AC Current	-	-	1.6 A	Measured at 100% load and 120Vac input.
	-	-	0.9 A	Measured at 100% load and 220Vac input.

## Input Specifications (Continued)

Parameter	Min.	Typ.	Max.	Notes
Inrush Current(I <sup>2</sup> t)	-	-	2.56 A <sup>2</sup> s	At 220Vac input, 25°C cold start, duration=760 μs, 10%Ipk-10%Ipk. See Inrush Current Waveform for the details.
PF	0.90	-	-	At 100-240Vac, 50-60Hz, 60%-100% load(90-150W)
THD	-	-	20%	
THD	-	-	10%	At 220-240Vac, 50-60Hz, 75%-100% load(112.5-150W)

## Output Specifications

Parameter	Min.	Typ.	Max.	Notes
Output Voltage Tolerance	-2.5%Vo	-	2.5%Vo	At 100% load condition
Output Voltage EUV-150S012DVA(SVA) EUV-150S024DVA(SVA)	- -	12.5 V 24.2 V	- -	At 100% load condition
Total Output Voltage Ripple (pk-pk)	-	-	2%Vo	Measured by 20 MHz bandwidth oscilloscope and the output paralleled a 0.1 uF ceramic capacitor and a 10 uF electrolytic capacitor.
Startup Overshoot/ Undershoot	-	-	5%Vo	At 100% load condition
Line Regulation	-	-	±0.5%	Measured at 100% load
Load Regulation	-	-	±1.5%	
Turn-on Delay Time	-	-	1.0 s	Measured at 120Vac input, 60%-100%load
	-	-	0.5 s	Measured at 220Vac input, 60%-100%load
Hold up Time	-	15 ms	-	Measured at 220Vac input, 100%load
Load Dynamic Response	Output Deviation	-	5%Vo	R/S: 1A/μs Load: 25% ~ 75% load
	Settling Time	-	10 ms	
Temperature Coefficient of Vo	-	0.03%/°C	-	Case temperature = 0°C~Tc max

**Note:** All specifications are typical at 25°C unless otherwise stated.

## General Specifications

Parameter	Min.	Typ.	Max.	Notes
Efficiency at 120Vac input: EUV-150S012DVA(SVA) EUV-150S024DVA(SVA)	85.5% 85.5%	87.5% 87.5%	- -	Measured at 100% load and steady-state temperature in 25°C ambient; (Efficiency will be about 2.0% lower if measured immediately after startup.)

## General Specifications (Continued)

Parameter	Min.	Typ.	Max.	Notes
Efficiency at 220Vac input: EUV-150S012DVA(SVA) EUV-150S024DVA(SVA)	88.0% 88.5%	90.0% 90.5%	- -	Measured at 100% load and steady-state temperature in 25°C ambient; (Efficiency will be about 2.0% lower if measured immediately after startup.)
Efficiency at 277Vac input: EUV-150S012DVA(SVA) EUV-150S024DVA(SVA)	88.5% 88.5%	90.5% 90.5%	- -	Measured at 100% load and steady-state temperature in 25°C ambient; (Efficiency will be about 2.0% lower if measured immediately after startup.)
Standby Power	-	-	0.5 W	Measured at 230Vac/50Hz; Dimming off
MTBF	-	258,000 Hours	-	Measured at 220Vac input, 80%Load and 25°C ambient temperature (MIL-HDBK-217F)
Lifetime	-	89,000 Hours	-	Measured at 220Vac input, 80%load and 70°C case temperature; See lifetime vs. Tc curve for the details
Operating Case Temperature for Safety Tc_s	-40°C	-	+90°C	
Operating Case Temperature for Warranty Tc_w	-40°C	-	+75°C	Case temperature for 5 years warranty
Storage Temperature	-40°C	-	+85°C	Humidity: 5%RH to 100%RH
Dimensions Inches (L x W x H) Millimeters (L x W x H)	7.08 x 2.66 x 1.44 180 x 67.5 x 36.5			With mounting ear 7.91 x 2.66 x 1.44 201 x 67.5 x 36.5
Net Weight	-	950 g	-	

**Note:** All specifications are typical at 25°C unless otherwise stated.

## Dimming Specifications

Parameter	Min.	Typ.	Max.	Notes
Absolute Maximum Voltage on the Vdim (+) Pin	-20 V	-	20 V	
Source Current on Vdim (+)Pin	135 µA	150 µA	165 µA	Vdim(+) = 0 V
Dimming Output Range	0.1%	-	100%	
Recommended Dimming Input Range	0 V	-	10 V	
Dim off Voltage	0.35 V	0.5 V	0.65 V	
Dim on Voltage	0.55 V	0.7 V	0.85 V	
Hysteresis	-	0.2 V	-	

**Note:** All specifications are typical at 25 °C unless stated otherwise.

● **Dimming Principle for PWM Style Output**

Parameter	Min.	Typ.	Max.	Notes
Output PWM frequency	-	0 Hz	-	Vdim(+) =9.0-10.0 V
	-	1.5 kHz	-	Vdim(+) =1.4-9.0 V
	300 Hz	-	1.5 kHz	Vdim(+) = 1.0-1.4 V

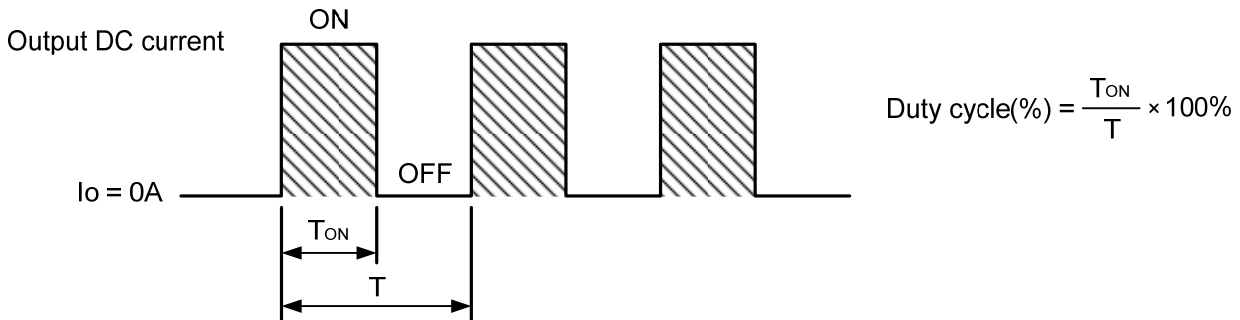

**Note:** Dimming is achieved by varying the duty cycle of the output current when driving LED strips.

**Safety & EMC Compliance**

Safety Category	Standard
CE	EN 61347-1, EN61347-2-13
CCC	GB 19510.1, GB 19510.14
KS	KS C 7655
EMI Standards	Notes
EN 55015 <sup>(1)</sup>	Conducted emission Test & Radiated emission Test
EN 61000-3-2	Harmonic current emissions
EN 61000-3-3	Voltage fluctuations & flicker
EMS Standards	Notes
EN 61000-4-2	Electrostatic Discharge (ESD): 8 kV air discharge, 4 kV contact discharge
EN 61000-4-3	Radio-Frequency Electromagnetic Field Susceptibility Test-RS
EN 61000-4-4	Electrical Fast Transient / Burst-EFT
EN 61000-4-5	Surge Immunity Test: AC Power Line: line to line 4 kV, line to earth 6 kV
EN 61000-4-6	Conducted Radio Frequency Disturbances Test-CS
EN 61000-4-8	Power Frequency Magnetic Field Test
EN 61000-4-11	Voltage Dips
EN 61547	Electromagnetic Immunity Requirements Applies To Lighting Equipment

**Note:** (1) This LED driver meets the EMI specifications above, but EMI performance of a luminaire that contains it depends also on the other devices connected to the driver and on the fixture itself.

## Derating

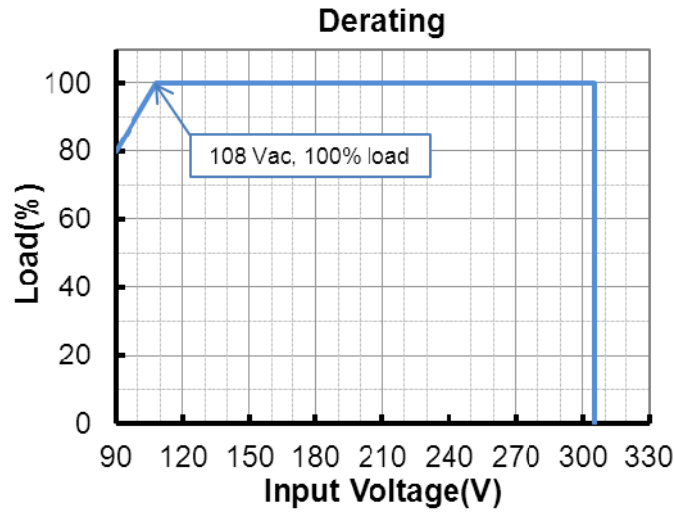

## Lifetime vs. Case Temperature

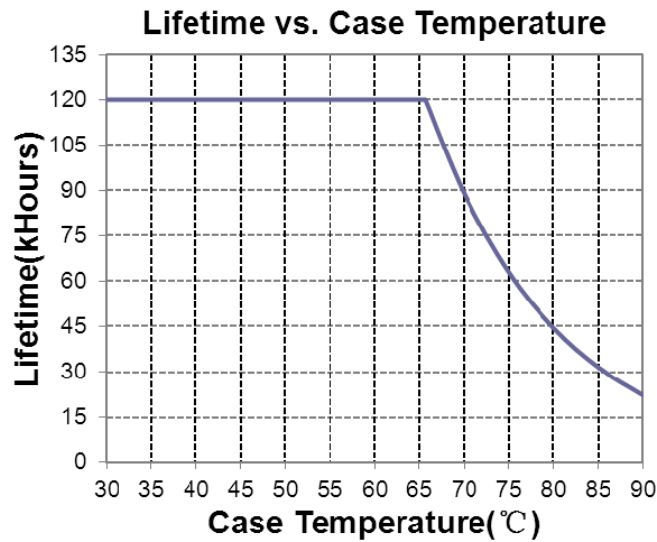

## Inrush Current Waveform

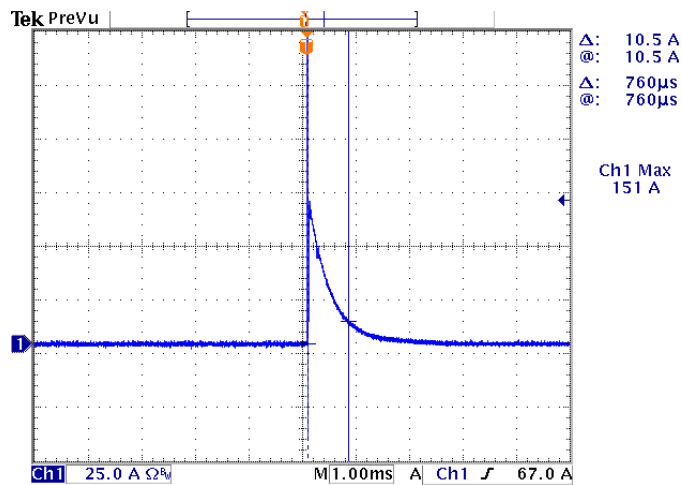

## Efficiency vs. Load

EUV-150S012DVA(SVA)

Efficiency vs. Output Current

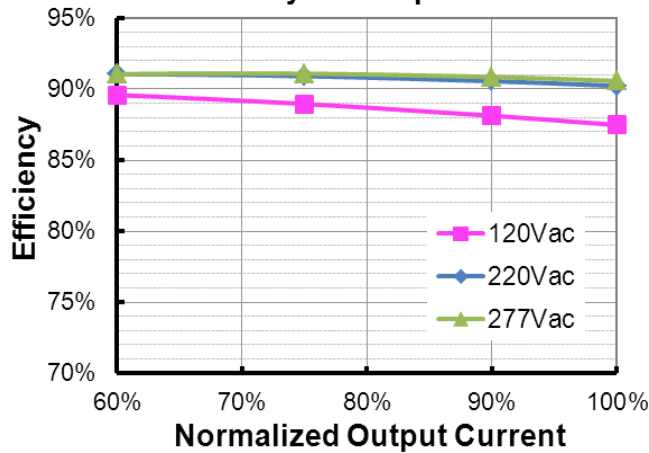

EUV-150S024DVA(SVA)

Efficiency vs. Output Current

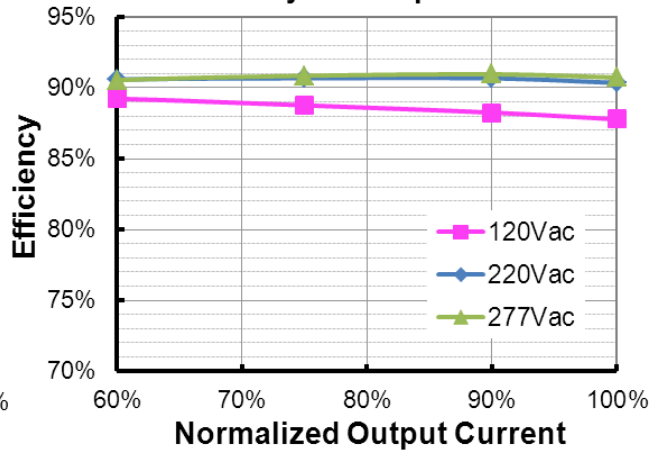

## Power Factor

PF vs. Load

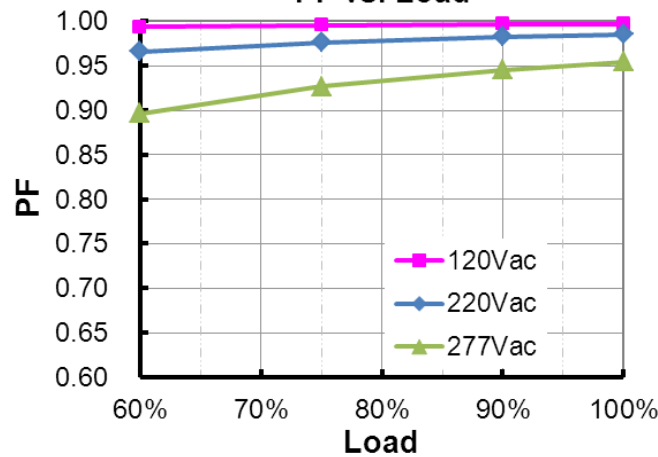

## Total Harmonic Distortion

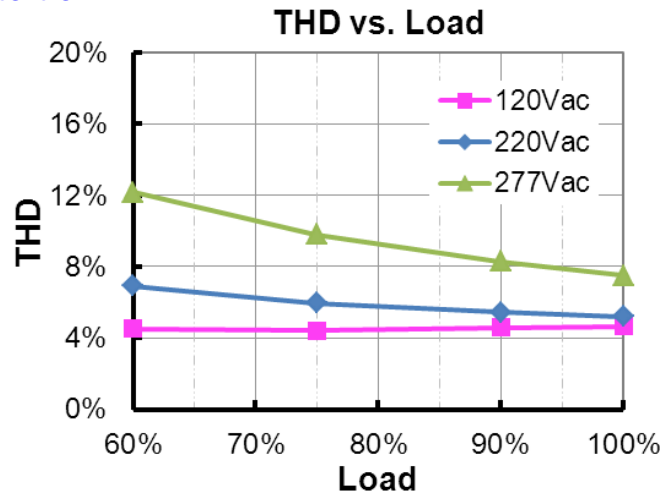

## Protection Functions

Parameter	Notes
Over Current Protection	Auto Recovery. The driver shall be self-recovery when the fault condition is removed.
Over Voltage Protection	Limits output voltage at no load and in case the normal voltage limit fails.
Short Circuit Protection	Auto Recovery. No damage will occur when any output is short circuited. The output shall return to normal when the fault condition is removed.
Over Temperature Protection	Auto Recovery. Returning to normal after over temperature is removed.

## Dimming

### ● 0-10V Dimming

The recommended implementation of the dimming control is provided below.

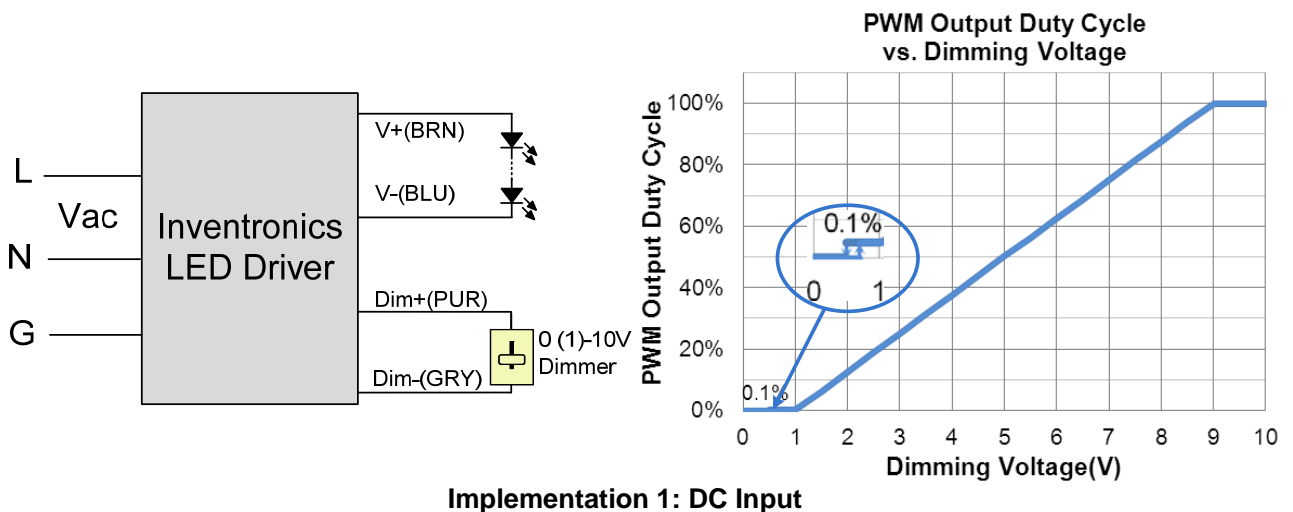

**Notes:**

1. The dimmer can also be replaced by an active 0-10V voltage source signal or passive components like resistors and zener diode.
2. Do NOT connect Dim- to the output V- or V+, otherwise the driver will not work properly.
3. If 0-10V dimming is not used, Dim + should be open.

● **Resister Dimming**

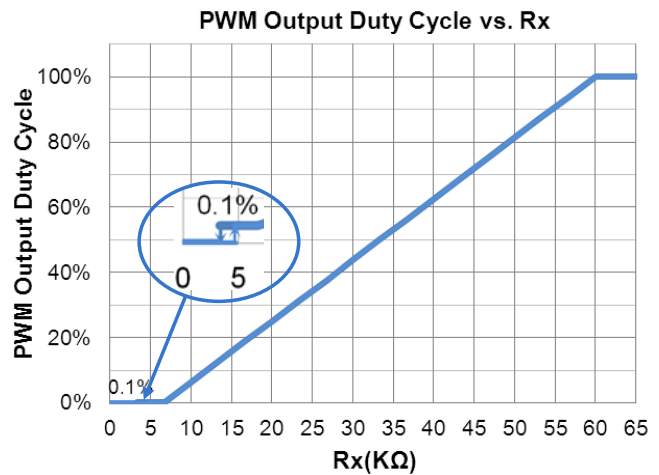
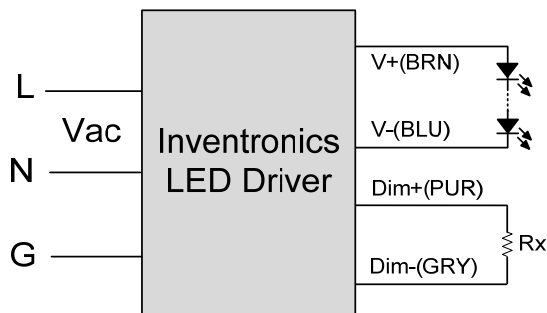

Implementation 2: External Resistor

**Mechanical Outline**

EUV-150S012DVA

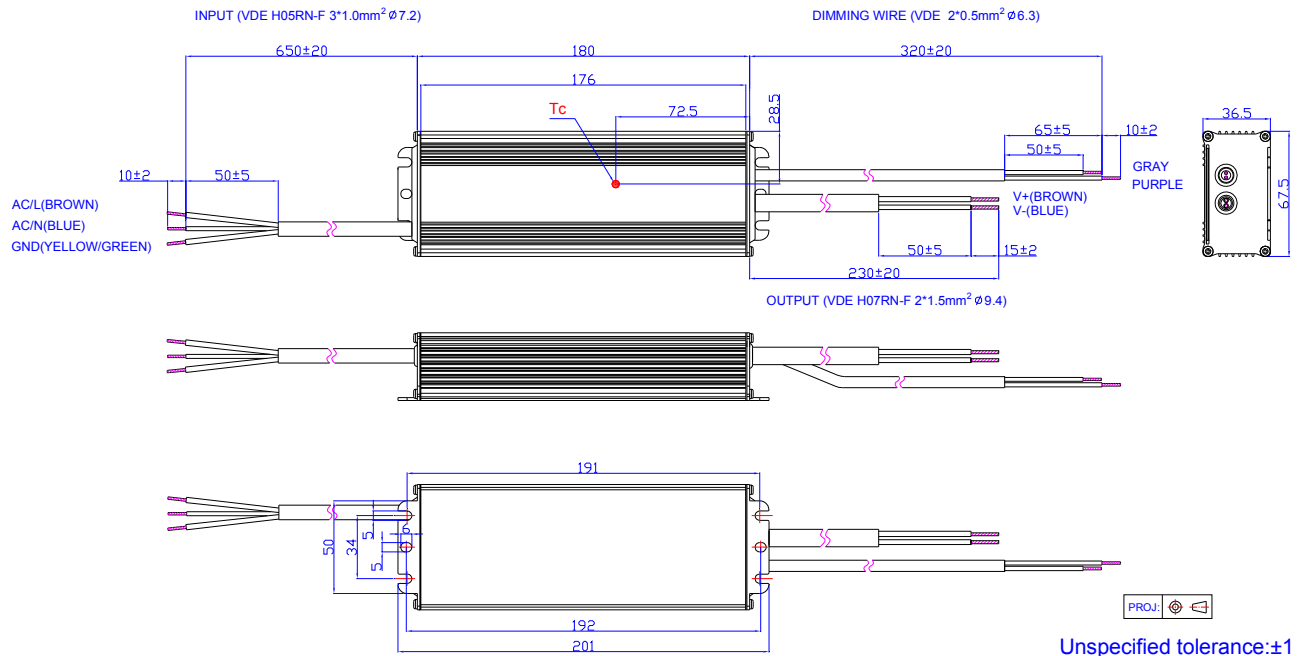



**EUV-150S024DVA**

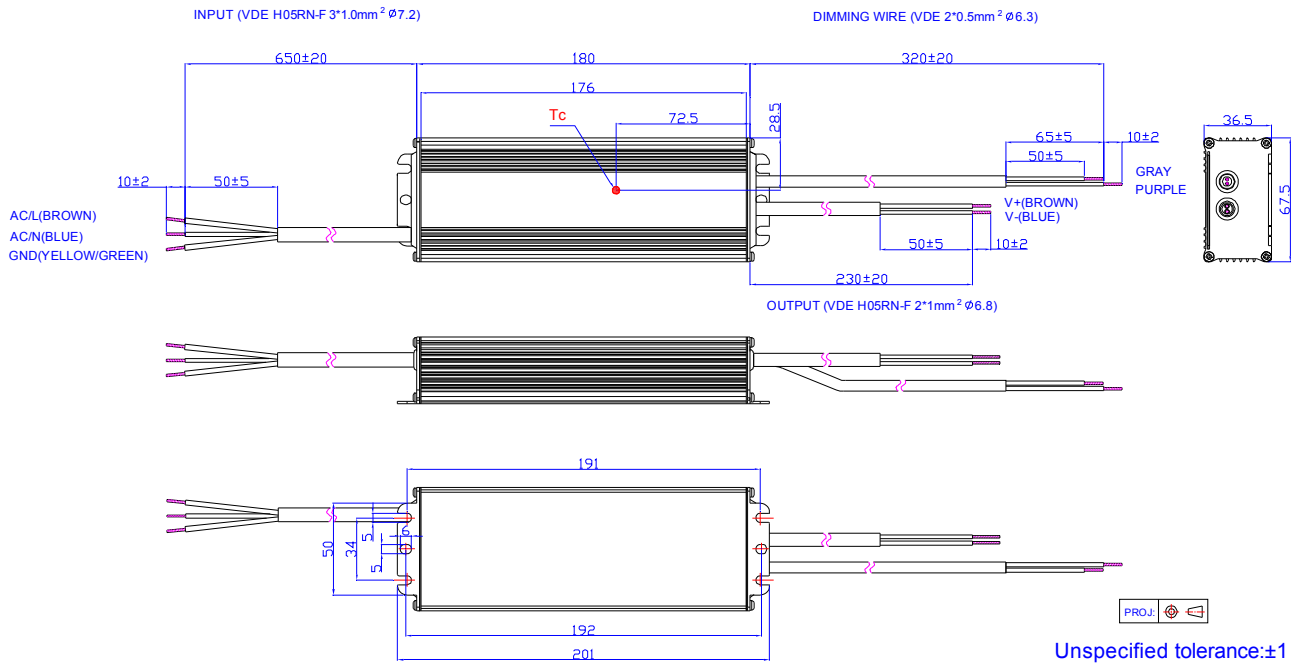

**EUV-150S012SVA**

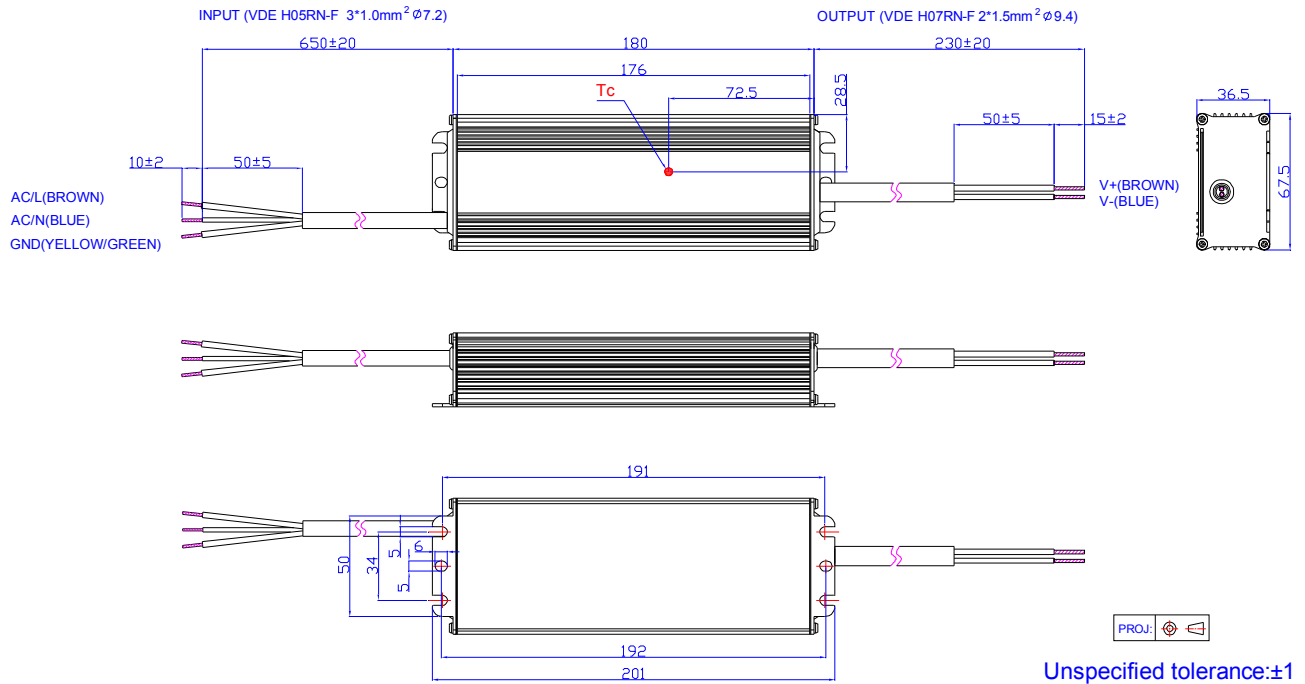

**EUV-150S024SVA**

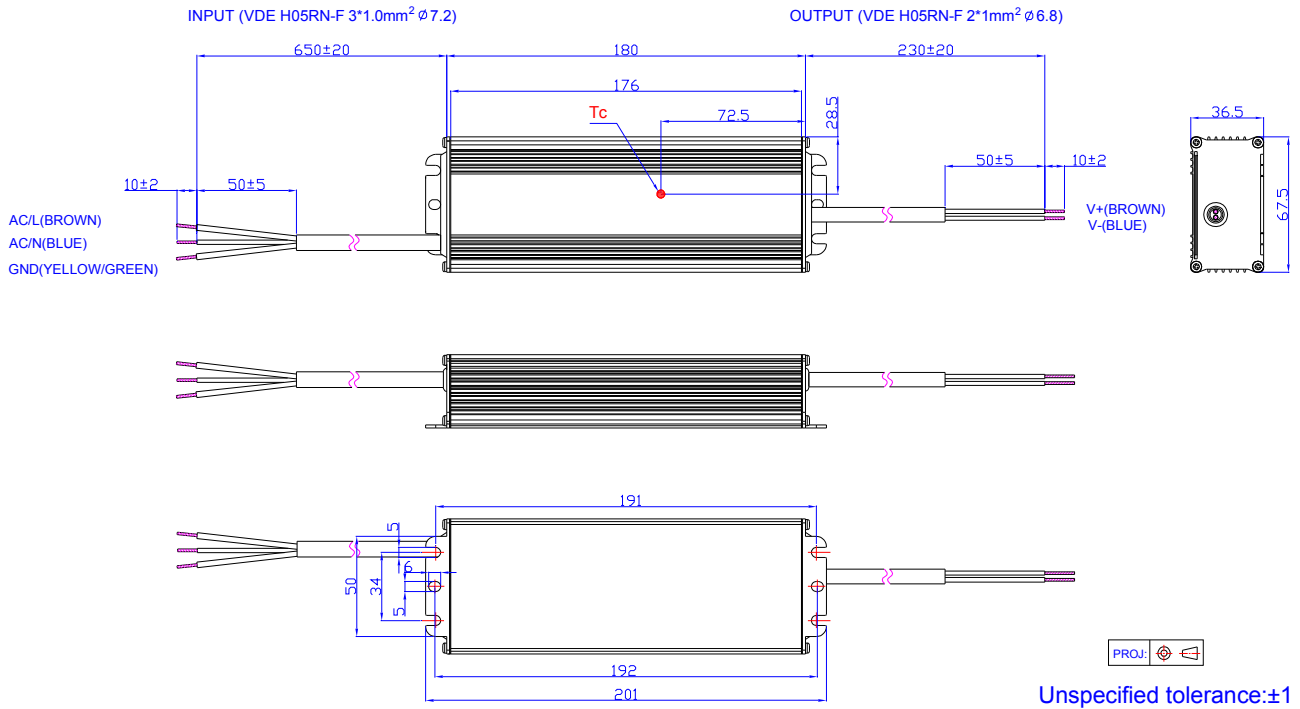

**RoHS Compliance**

Our products comply with the European Directive 2011/65/EU, calling for the elimination of lead and other hazardous substances from electronic products.

## Revision History

Change Date	Rev.	Description of Change		
		Item	From	To
2018-02-05	A	Datasheet Release	/	/
2018-03-09	B	Features	/	Updated
		Note of Dimming Specifications - Dimming Output Range	/	Deleted
2018-07-12	C	ENEC Certificate	/	Added