

Features

- High Efficiency (Up to 90.5%)
- Full Power at Wide Output Current Range (Constant Power)
- Compact Package Design
- 0-5V/0-10V/PWM/Timer Dimmable
- Input Surge Protection: DM 6 kV, CM 10 kV
- All-Around Protection: OVP, SCP, OTP
- Waterproof (IP67)
- SELV Output



Description

The EBD-075SxxxDV series is a 75W, constant-current, programmable LED driver that operates from 176-305 Vac input with excellent power factor. It is created for many lighting applications including low bay, tunnel and street, etc. The high efficiency of these drivers and compact metal case enables them to run cooler, significantly improving reliability and extending product life. To ensure trouble-free operation, protection is provided against input surge, output over voltage, short circuit, and over temperature.

Models

Output Current Range	Full-Power Current Range (1)	Default Output Current	Input Voltage Range(2)	Output Voltage Range	Max. Output Power	Typical Efficiency (3)	Power Factor (3)	Model Number (4)
70-1050 mA	700-1050 mA	700 mA	176~305 Vac	43~107 Vdc	75 W	90.5%	0.98	EBD-075S105DV
170-2500 mA	1700-2500 mA	2100 mA	176~305 Vac	18~ 44 Vdc	75 W	89.5%	0.98	EBD-075S250DV

- Notes:** (1) Output current range with constant power at 75W
 (2) CCC certified input voltage range: 220/230/240Vac; otherwise: 200-240Vac
 (3) Measured at 100% load and 220Vac input (see below "General Specifications" for details).
 (4) SELV output

I-V Operation Area

EBD-075S105DV

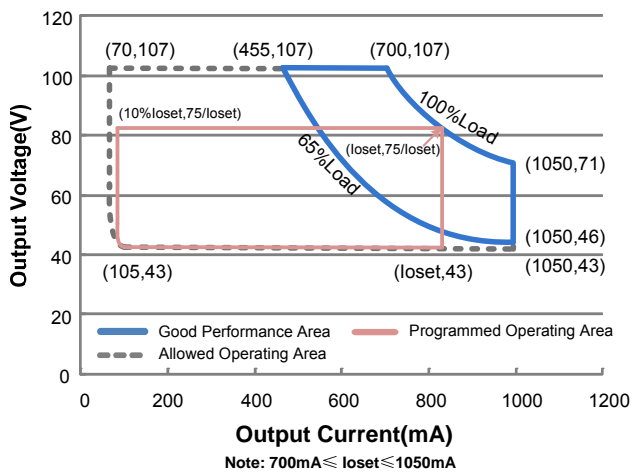

EBD-075S250DV

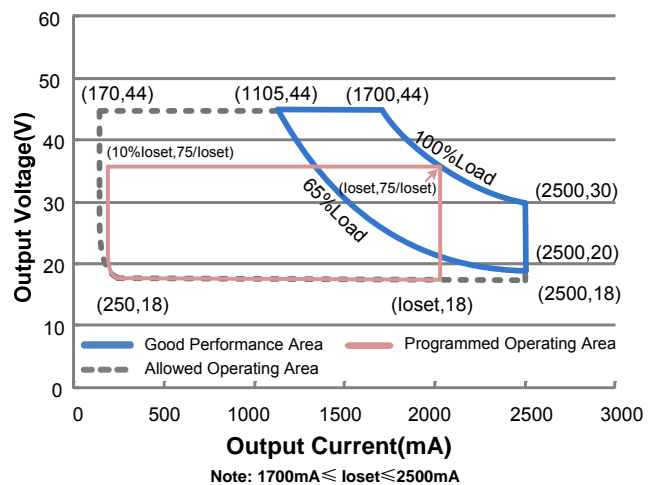

Input Specifications

Parameter	Min.	Typ.	Max.	Notes
Input Voltage	176 Vac	-	305 Vac	
Input Frequency	47 Hz	-	63 Hz	
Leakage Current	-	-	0.70 mA	IEC60598-1; 240Vac/ 60Hz
Input AC Current	-	-	0.46 A	Measured at 100% load and 220 Vac input.
Inrush Current(I ² t)	-	-	1.3 A ² s	At 220Vac input, 25°C cold start, duration=584 us, 10%l _{pk} -10%l _{pk} . See Inrush Current Waveform for the details.
PF	0.9	-	-	At 220-240Vac, 50-60Hz, 65%-100% Load (49-75W)
THD	-	-	20%	

Output Specifications

Parameter	Min.	Typ.	Max.	Notes
Output Current Tolerance	-5%loset	-	5%loset	At 100% load condition
Output Current Setting(loset) Range				
EBD-075S105DV	70 mA	-	1050 mA	
EBD-075S250DV	170 mA	-	2500 mA	
Output Current Setting Range with Constant Power				
EBD-075S105DV	700 mA	-	1050 mA	
EBD-075S250DV	1700 mA	-	2500 mA	
Total Output Current Ripple (pk-pk)	-	5%l _{omax}	10%l _{omax}	At 100% load condition, 20 MHz BW
Output Current Ripple at < 200 Hz (pk-pk)	-	1%l _{omax}	-	At 100% load condition. Only this component of ripple is associated with visible flicker.
Startup Overshoot Current	-	-	10%l _{omax}	At 100% load condition
No Load Output Voltage				
EBD-075S105DV	-	-	117 V	
EBD-075S250DV	-	-	59 V	
Line Regulation	-	-	±0.5%	Measured at 100% load
Load Regulation	-	-	±1.5%	
Turn-on Delay Time	-	0.5 s	1.5 s	Measured at 220Vac input. 65%-100% Load
Temperature Coefficient	-	0.03%/°C	-	Case temperature = 0°C ~T _c max
12V Auxiliary Output Voltage	10.8 V	12 V	13.2 V	
12V Auxiliary Output Source Current	0 mA	-	20 mA	Return terminal is "Dim"

Note: All specifications are typical at 25°C unless otherwise stated.

General Specifications

Parameter	Min.	Typ.	Max.	Notes
Efficiency at 220 Vac input: EBD-075S105DV I _o =700 mA I _o =1050 mA EBD-075S250DV I _o =1700 mA I _o =2500 mA	88.5% 88.5%	90.5% 90.5%	- -	Measured at 100% load and steady-state temperature in 25°C ambient; (Efficiency will be about 2.0% lower if measured immediately after startup.)
MTBF	-	346,000 Hours	-	Measured at 220Vac input, 80%Load and 25°C ambient temperature (MIL-HDBK-217F)
Lifetime	-	73,000 Hours	-	Measured at 220Vac input, 80%Load and 70°C case temperature; See lifetime vs. T _c curve for the details
Operating Case Temperature for Safety T _{c_s}	-40°C	-	+90°C	
Operating Case Temperature for Warranty T _{c_w}	-40°C	-	+75°C	
Storage Temperature	-40°C	-	+85°C	Humidity: 5%RH to 100%RH
Dimensions Inches (L × W × H) Millimeters (L × W × H)	5.91 × 2.66 × 1.44 150 × 67.5 × 36.5			With mounting ear 6.97 × 2.66 × 1.44 177 × 67.5 × 36.5
Net Weight	-	785 g	-	

Note: All specifications are typical at 25°C unless otherwise stated.

Dimming Specifications

Parameter	Min.	Typ.	Max.	Notes	
Absolute Maximum Voltage on the V _{dim} (+) Pin	-20 V	-	20 V		
Source Current on V _{dim} (+)Pin	200 uA	300 uA	450 uA	V _{dim} (+) = 0 V	
Dimming Output Range	EBD-075S105DV EBD-075S250DV	10%loset	-	loset	700mA ≤ I _o set ≤ 1050mA 1700mA ≤ I _o set ≤ 2500mA
	EBD-075S105DV EBD-075S250DV	70mA 170mA	-	loset	70mA ≤ I _o set < 700mA 170mA ≤ I _o set < 1700mA
Recommended Dimming Range for 0-5V	0 V	-	5 V	Dimming mode set to 0-5V in PC interface.	
Recommended Dimming Range for 0-10V	0 V	-	10 V	Default 0-10V dimming mode with positive logic.	
PWM_in High Level	3 V	-	10 V	Dimming mode set to PWM in PC interface.	
PWM_in Low Level	-0.3 V	-	0.6 V		
PWM_in Frequency Range	200 Hz	-	2 KHz		
PWM_in Duty Cycle	1%	-	99%		

Note: All specifications are typical at 25°C unless otherwise stated.

Safety & EMC Compliance

Safety Category	Standard
TUV & CE	EN 61347-1, EN61347-2-13
CB	IEC 61347-1, IEC 61347-2-13
CCC	GB 19510.1, GB 19510.14
KS	KS C 7655
EMI Standards	Notes
EN 55015/GB 17743 ⁽¹⁾	Conducted emission Test & Radiated emission Test
EN 61000-3-2/GB 17625.1	Harmonic current emissions
EN 61000-3-3	Voltage fluctuations & flicker
EMS Standards	Notes
EN 61000-4-2	Electrostatic Discharge (ESD): 8 kV air discharge, 4 kV contact discharge
EN 61000-4-3	Radio-Frequency Electromagnetic Field Susceptibility Test-RS
EN 61000-4-4	Electrical Fast Transient / Burst-EFT
EN 61000-4-5	Surge Immunity Test: AC Power Line: Differential Mode 6 kV, Common Mode 10 kV ⁽²⁾
EN 61000-4-6	Conducted Radio Frequency Disturbances Test-CS
EN 61000-4-8	Power Frequency Magnetic Field Test
EN 61000-4-11	Voltage Dips
EN 61547	Electromagnetic Immunity Requirements Applies To Lighting Equipment

- Note:** (1) This LED driver meets the EMI specifications above, but EMI performance of a luminaire that contains it depends also on the other devices connected to the driver and on the fixture itself.
 (2) To perform electric strength (hi-pot) testing, the “GDT ground disconnect” (screw and metal lock sheet) on the driver end-cap should be removed temporarily to prevent the internal gas discharge tube from conducting (as allowed by IEC 60598-1 Clause 10.2). After testing is completed, these items must be reinstalled to restore line-to-earth surge protection and secure the end cap.

Lifetime vs. Case Temperature

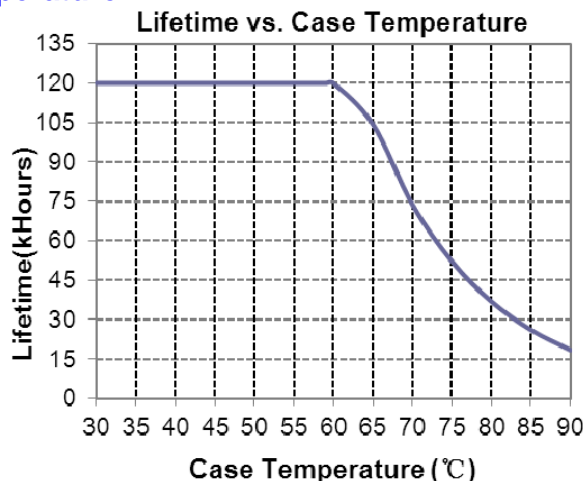

Inrush Current Waveform

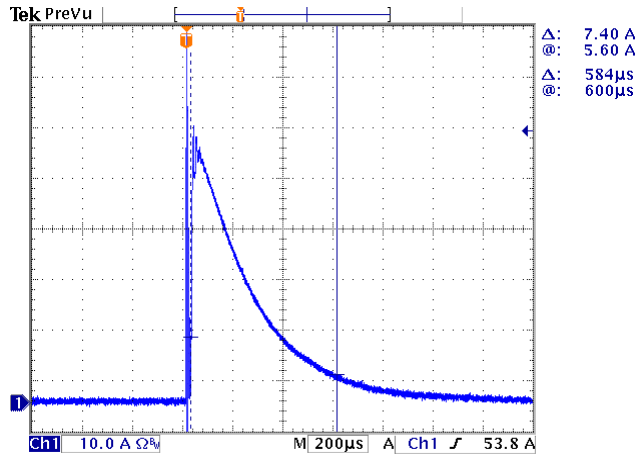

Efficiency vs. Load

EBD-075S105DV($I_o=700mA$)
Efficiency vs. Output Voltage

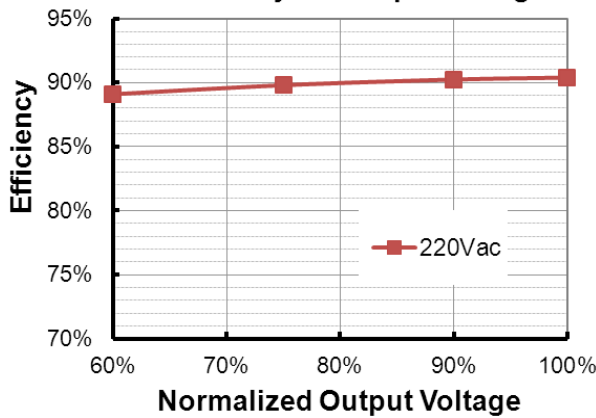

EBD-075S105DV($I_o=1050mA$)
Efficiency vs. Output Voltage

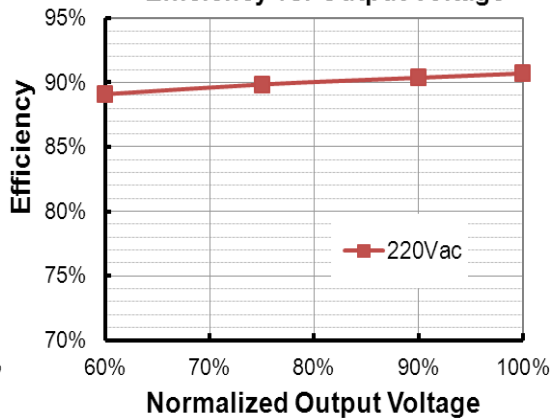

EBD-075S250DV($I_o=1700mA$)
Efficiency vs. Output Voltage

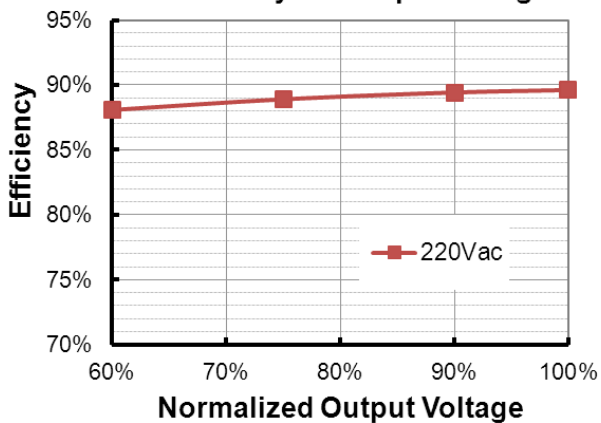

EBD-075S250DV($I_o=2500mA$)
Efficiency vs. Output Voltage

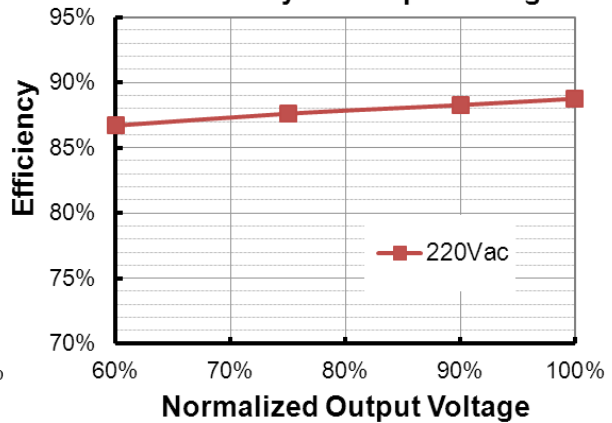

Power Factor

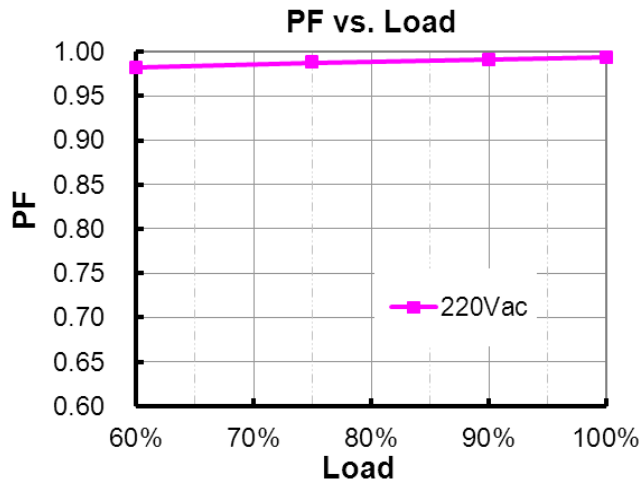

Total Harmonic Distortion

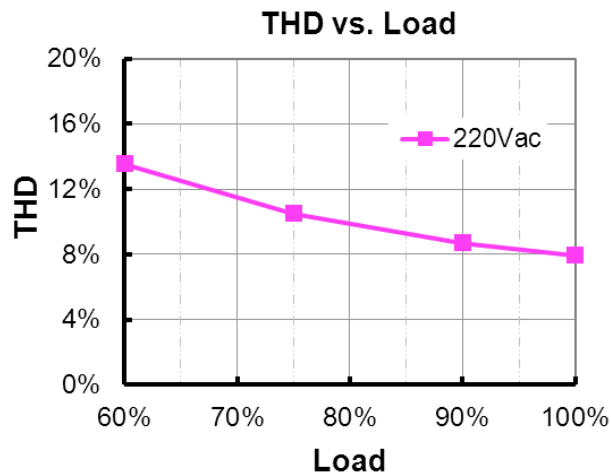

Protection Functions

Parameter	Notes
Over Temperature Protection	Decreases output current, returning to normal after over temperature is removed.
Short Circuit Protection	Auto Recovery. No damage will occur when any output is short circuited. The output shall return to normal when the fault condition is removed.
Over Voltage Protection	Limits output voltage at no load and in case the normal voltage limit fails.

Dimming

● 0-5V Dimming

The recommended implementation of the dimming control is provided below.

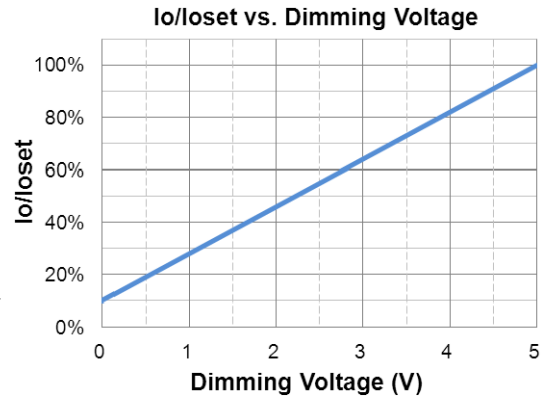
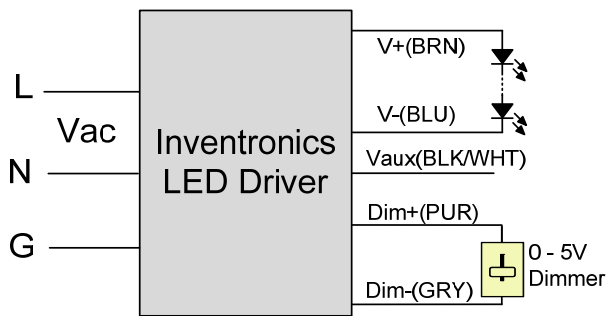

Implementation 1: Positive logic

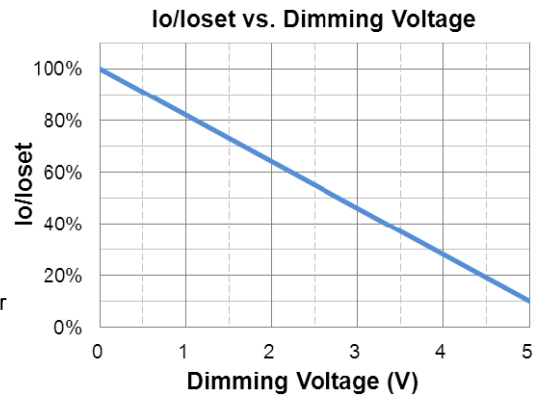
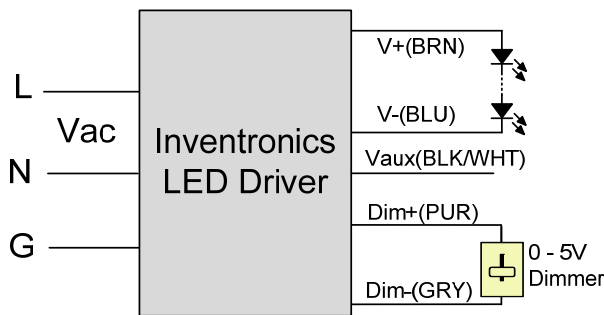

Implementation 2: Negative logic

Notes:

1. The dimmer can also be replaced by an active 0-5V voltage source signal or passive components like resistors and zener.
2. Do NOT connect Dim- to the output V- or V+, otherwise the driver will not work properly.
3. If 0-5V dimming is not used, Dim + should be open.
4. When 0-5V negative logic dimming mode and Dim+ is open, the driver will output maximum current.

● **0-10V Dimming**

The recommended implementation of the dimming control is provided below.

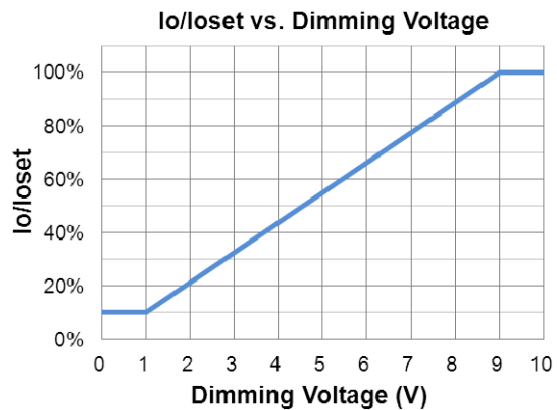
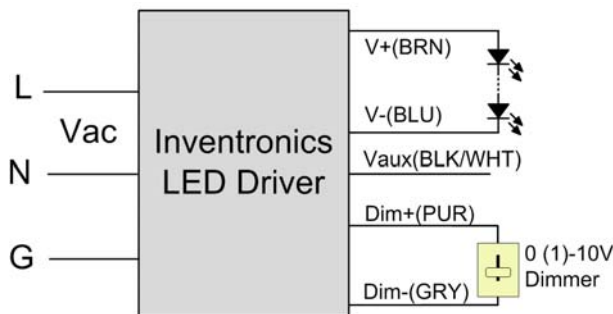

Implementation 3: Positive logic

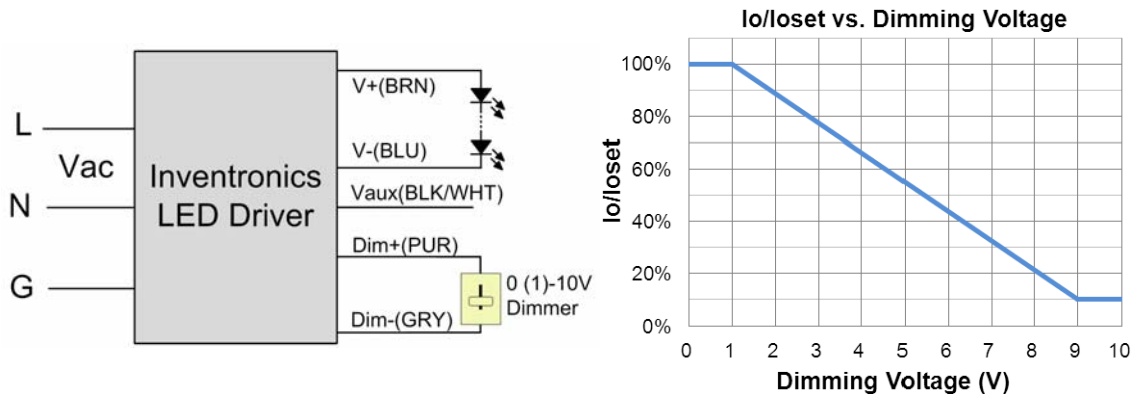

Implementation 4: Negative logic

Notes:

1. The dimmer can also be replaced by an active 0-10V voltage source signal or passive components like resistors and zener.
2. Do NOT connect Dim- to the output V- or V+, otherwise the driver will not work properly.
3. If 0-10V dimming is not used, Dim + should be open.
4. When 0-10V negative logic dimming mode and Dim+ is open, the driver will output minimum current.

● **PWM Dimming**

The recommended implementation of the dimming control is provided below.

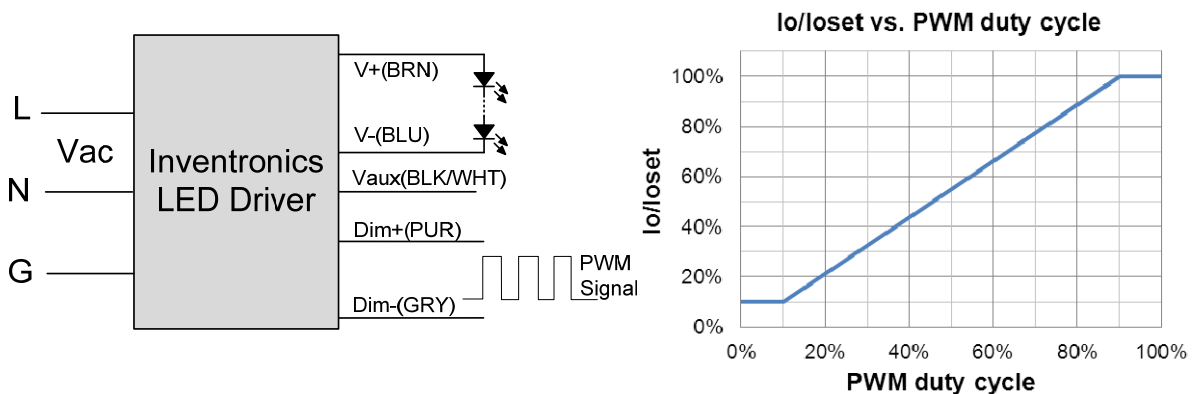

Implementation 5: Positive logic

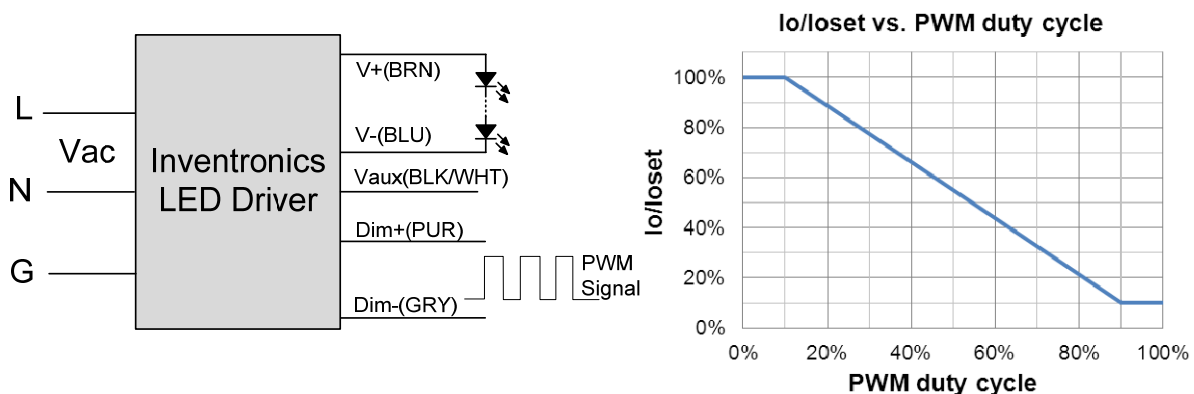

Implementation 6: Negative logic

Notes:

1. Do NOT connect Dim- to the output V- or V+, otherwise the driver will not work properly.
2. If PWM dimming is not used, Dim + should be open.
3. When PWM negative logic dimming mode and Dim+ is open, the driver will output minimum current.

● **Time Dimming**

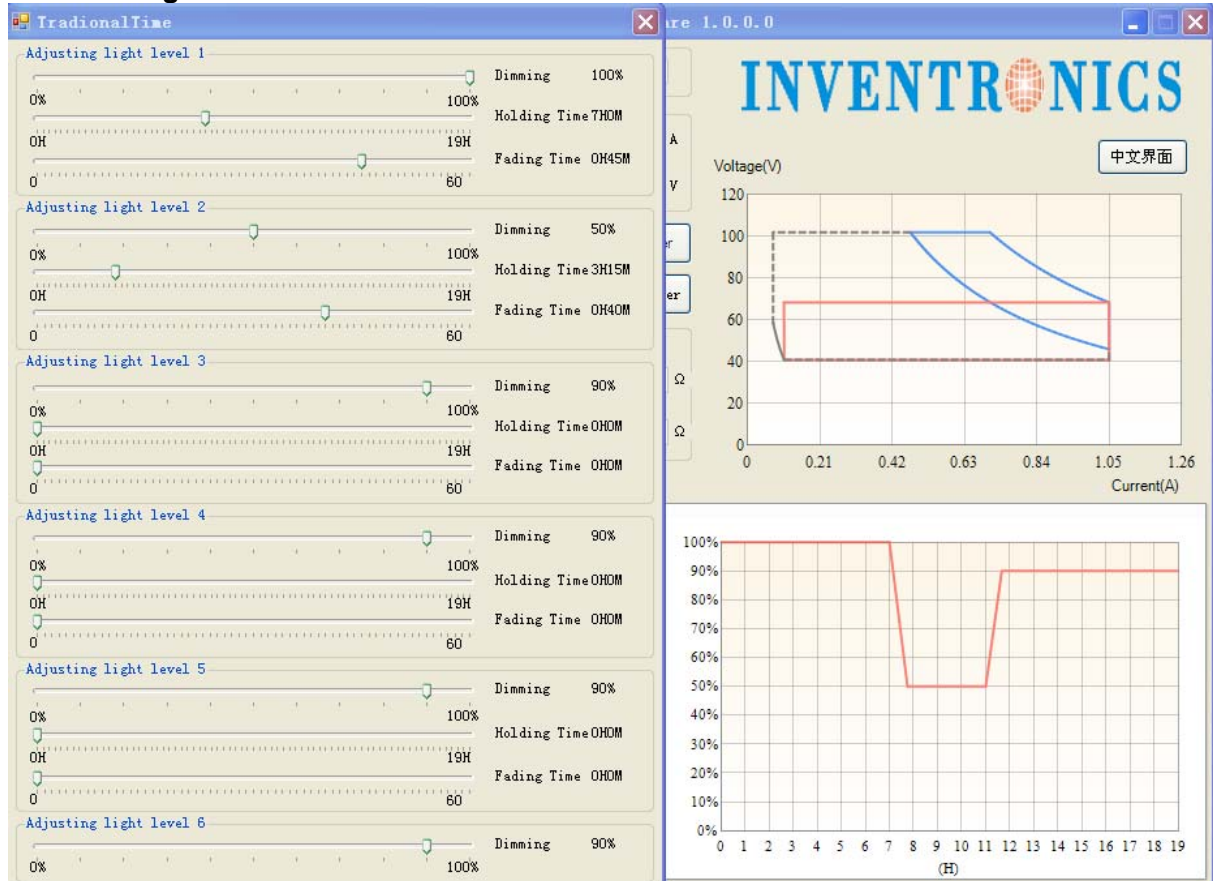

Set the timing curve by pulling the sliders.

Programming Connection Diagram

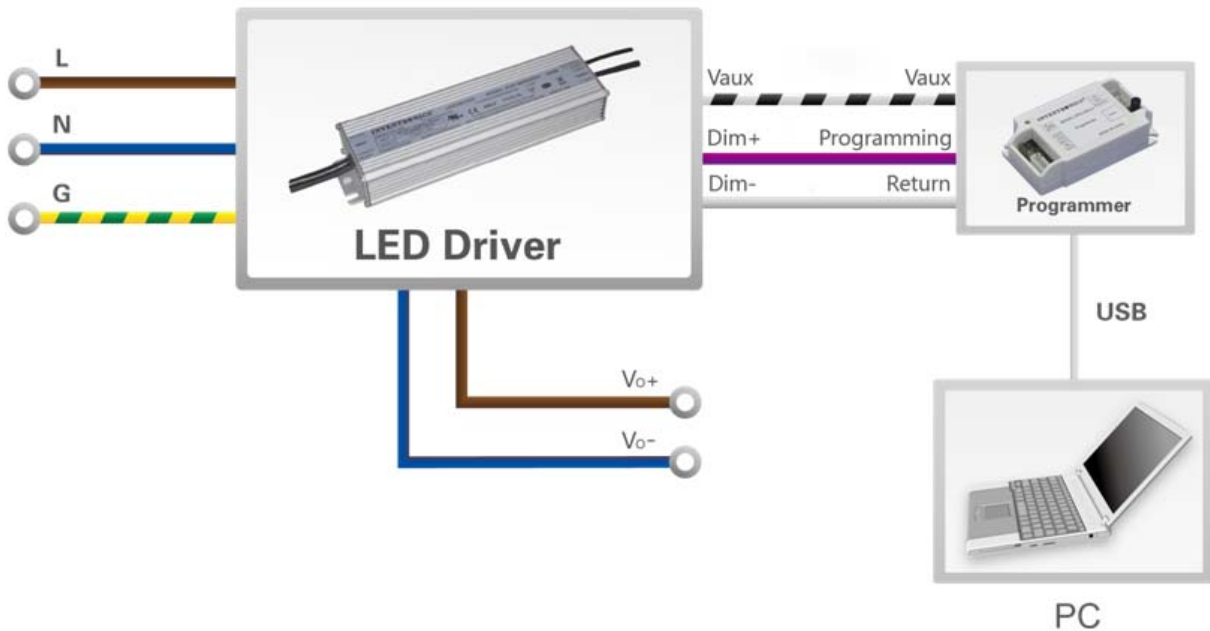

Note: The driver does not need to be powered on during the programming process.

- Please refer to [PRG-MUL2](#) Multi-Programmer datasheet for details.

Mechanical Outline

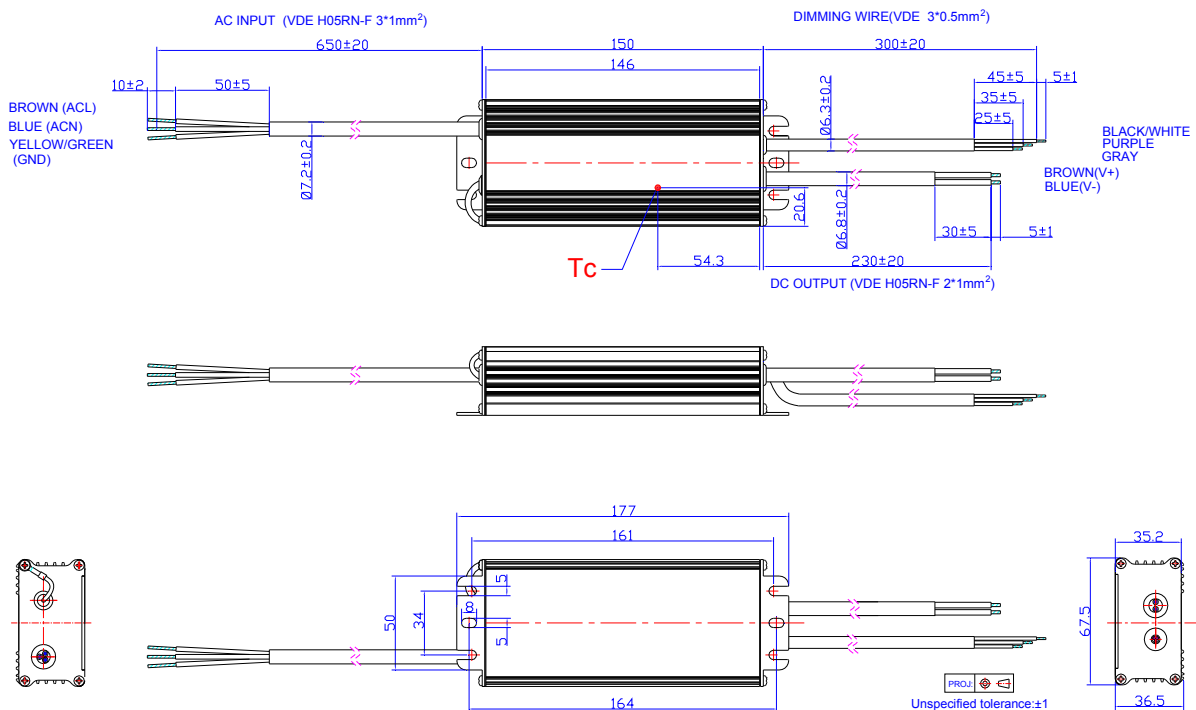

Note: Waterproof connectors certified to CCC & CE are also available for these drivers; please contact Inventronics Sales.

RoHS Compliance

Our products comply with reference to RoHS Directive (EU) 2015/863 amending 2011/65/EU, calling for the elimination of lead and other hazardous substances from electronic products.

Revision History

Change Date	Rev.	Description of Change		
		Item	From	To
2015-04-14	A	Datasheets Release	/	/
2015-12-08	B	KS	/	Added
		Input surge protection	/	Updated
2016-03-31	C	General Specifications	Lifetime	Updated
		General Specifications	With mounting ear	Added
		General Specifications	Net Weight	Updated
		Safety &EMC Compliance	/	Updated
		Mechanical Outline	/	Updated
2019-08-09	D	Features	Input surge protection	Updated
		TUV	/	Updated
		Features	Suitable for Independent Use	Independent Logo
		Description	/	Updated
		Input Specifications(PF/THD)	50-60Hz	Added
		Output Specifications (Turn-on Delay Time)	65%-100% Load	Added
		Safety &EMC Compliance	TUV	Added
		Safety &EMC Compliance	CB	Added
		Safety &EMC Compliance	KS	Updated
		Safety &EMC Compliance	EN 61000-4-5	Updated
		RoHS Compliance	/	Updated