

Features

- Ultra High Efficiency (Up to 94.5%)
- Full Power at Wide Output Current Range (Constant Power)
- Thermal Sensing and Protection for LED Module
- 0-10V/PWM/3-Timer-Modes Dimmable
- Dim-to-Off with Standby Power ≤ 1.5 W
- Output Lumen Compensation
- Input Surge Protection: DM 6kV, CM 10kV
- All-Around Protection: OVP, SCP, OTP
- IP67 and UL Dry / Damp / Wet Location
- SELV Output
- TYPE HL, for use in a Class I, Division 2 hazardous (Classified) location
- 5 Years Warranty



Description

The ESD-150SxxxDT series is a 150W, constant-current, programmable LED driver that operates from 249-528 Vac input with excellent power factor. Created for many lighting applications including high bay, tunnel and roadway, it provides a dim-off mode with low standby power. The high efficiency of these drivers and compact metal case enables them to run cooler, significantly improving reliability and extending product life. To ensure trouble-free operation, protection is provided against input surge, output over voltage, short circuit, and over temperature.

Models

Adjustable Output Current Range	Full-Power Current Range (1)	Default Output Current	Input Voltage Range (2)	Output Voltage Range	Max. Output Power	Typical Efficiency (3)	Typical Power Factor		Model Number
							277Vac	480Vac	
70-1050mA	700-1050mA	700 mA	249~528 Vac 352~500 Vdc	75~214Vdc	150 W	94.5%	0.96	0.95	ESD-150S105DT
140-2100mA	1400-2100mA	1400 mA	249~528 Vac 352~500 Vdc	38~107Vdc	150 W	94.0%	0.96	0.95	ESD-150S210DT
245-3500mA	2450-3500mA	2800 mA	249~528 Vac 352~500 Vdc	22 ~ 61Vdc	150 W	93.0%	0.96	0.95	ESD-150S350DT ⁽⁴⁾
385-5600mA	3850-5600mA	4200 mA	249~528 Vac 352~500 Vdc	14 ~ 39Vdc	150 W	93.0%	0.96	0.95	ESD-150S560DT ⁽⁴⁾

- Notes:** (1) Output current range with constant power at 150W
 (2) Certified input voltage range: 277-480Vac or 352-500Vdc
 (3) Measured at 100% load and 480Vac input (see below "General Specifications" for details).
 (4) SELV Output

I-V Operating Area

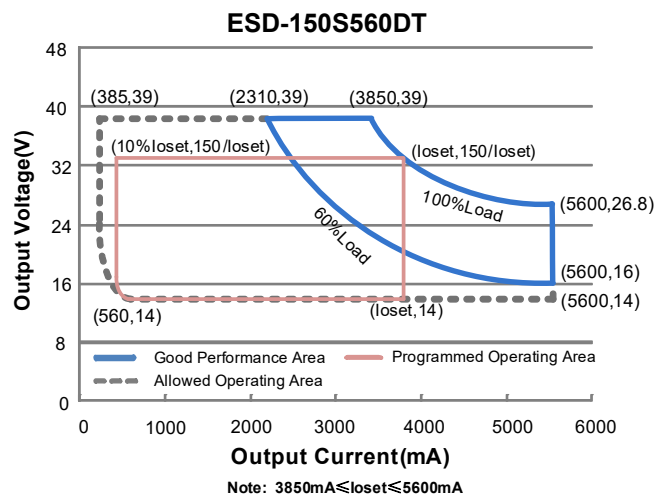
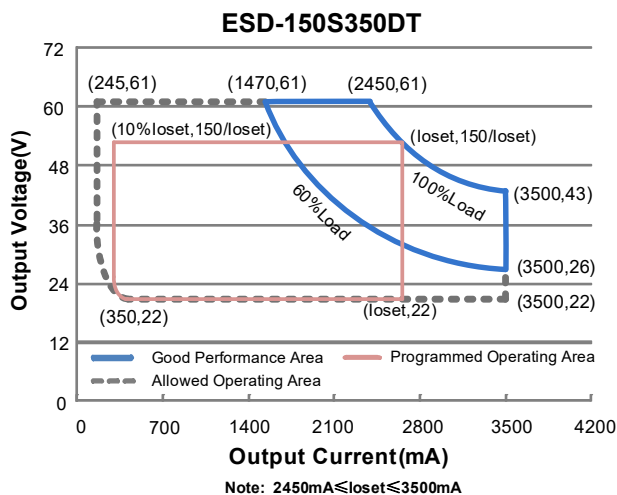
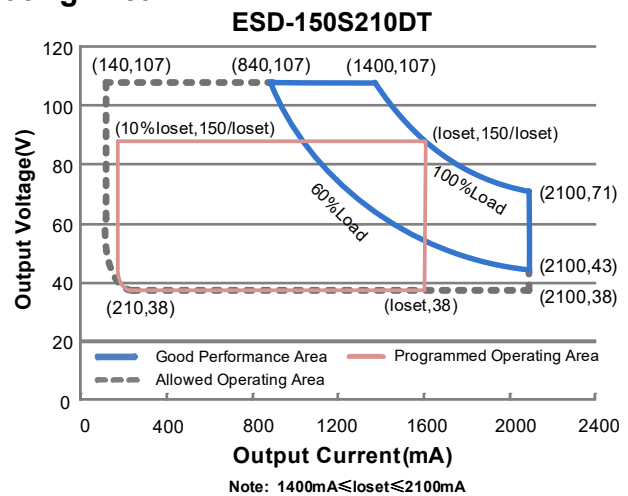
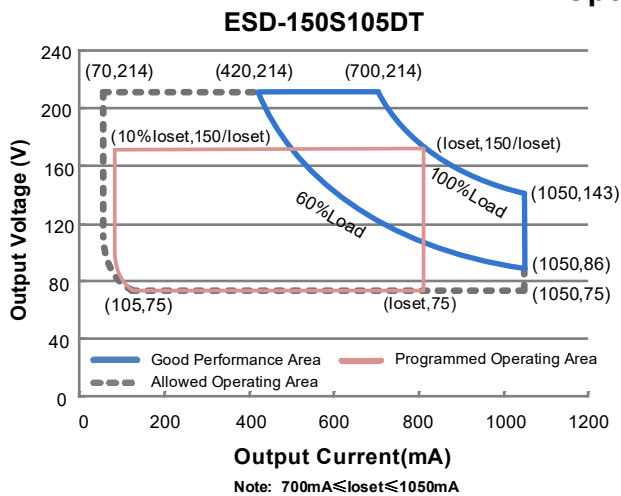

Input Specifications

Parameter	Min.	Typ.	Max.	Notes
Input AC Voltage	249 Vac	-	528 Vac	
Input DC Voltage	352 Vdc	-	500 Vdc	
Input Frequency	47 Hz	-	63 Hz	
Leakage Current	-	-	0.75 MIU	UL8750; 480Vac/ 60Hz, grounding effectively
	-	-	0.70 mA	IEC60598-1; 480Vac/ 60Hz, grounding effectively
Input AC Current	-	-	0.70 A	Measured at 100% load and 277 Vac input.
	-	-	0.40 A	Measured at 100% load and 480 Vac input.
Inrush Current(I ² t)	-	-	7.6 A ² s	At 480Vac input, 25°C Cold Start, Duration=680 μs, 10%Ipk-10%Ipk. See Inrush Current Waveform for the details.

Input Specifications (Continued)

Parameter	Min.	Typ.	Max.	Notes
PF	0.90	-	-	At 277-480Vac, 50-60Hz, 60%-100% Load (90-150W)
THD	-	-	20%	

Output Specifications

Parameter	Min.	Typ.	Max.	Notes
Output Current Tolerance	-5%loset	-	5%loset	At 100% load condition
Output Current Setting(loset) Range				
ESD-150S105DT	70 mA	-	1050 mA	
ESD-150S210DT	140 mA	-	2100 mA	
ESD-150S350DT	245 mA	-	3500 mA	
ESD-150S560DT	385 mA	-	5600 mA	
Output Current Setting Range with Constant Power				
ESD-150S105DT	700 mA	-	1050 mA	
ESD-150S210DT	1400 mA	-	2100 mA	
ESD-150S350DT	2450 mA	-	3500 mA	
ESD-150S560DT	3850 mA	-	5600 mA	
Total Output Current Ripple (pk-pk)	-	5%lomax	10%lomax	At 100% load condition, 20 MHz BW
Output Current Ripple at < 200 Hz (pk-pk)	-	2%lomax	-	At 100% load condition. Only this component of ripple is associated with visible flicker.
Startup Overshoot Current	-	-	10%lomax	At 100% load condition
No Load Output Voltage				
ESD-150S105DT	-	-	223 V	
ESD-150S210DT	-	-	116 V	
ESD-150S350DT	-	-	64 V	
ESD-150S560DT	-	-	43 V	
Line Regulation	-	-	±0.5%	Measured at 100% load
Load Regulation	-	-	±1.5%	
Turn-on Delay Time	-	0.5 s	0.75 s	Measured at 277Vac and 480Vac input, 60%-100% Load
Temperature Coefficient of loset	-	0.03%/°C	-	Case temperature = 0°C ~Tc max
12V Auxiliary Output Voltage (Vaux)	10.8 V	12 V	13.2 V	
12V Auxiliary Output Source Current (Iaux)	0 mA	-	200 mA	Return terminal is "Dim-"

General Specifications

Parameter	Min.	Typ.	Max.	Notes
Efficiency at 277 Vac input: ESD-150S105DT				Measured at 100% load and steady-state temperature in 25°C ambient; (Efficiency will be about 2.0% lower if measured immediately after startup.)
I _o = 700mA	91.5%	93.5%	-	
I _o =1050mA	89.5%	91.5%	-	
ESD-150S210DT				
I _o =1400mA	91.0%	93.0%	-	
I _o =2100mA	90.0%	92.0%	-	
ESD-150S350DT				
I _o =2450mA	91.0%	93.0%	-	
I _o =3500mA	89.0%	91.0%	-	
ESD-150S560DT				
I _o =3850mA	90.5%	92.5%	-	
I _o =5600mA	88.0%	90.0%	-	
Efficiency at 347 Vac input: ESD-150S105DT				Measured at 100% load and steady-state temperature in 25°C ambient; (Efficiency will be about 2.0% lower if measured immediately after startup.)
I _o = 700mA	92.0%	94.0%	-	
I _o =1050mA	90.5%	92.5%	-	
ESD-150S210DT				
I _o =1400mA	91.5%	93.5%	-	
I _o =2100mA	90.5%	92.5%	-	
ESD-150S350DT				
I _o =2450mA	91.5%	93.5%	-	
I _o =3500mA	89.5%	91.5%	-	
ESD-150S560DT				
I _o =3850mA	90.5%	92.5%	-	
I _o =5600mA	88.5%	90.5%	-	
Efficiency at 480 Vac input: ESD-150S105DT				Measured at 100% load and steady-state temperature in 25°C ambient; (Efficiency will be about 2.0% lower if measured immediately after startup.)
I _o = 700mA	92.5%	94.5%	-	
I _o =1050mA	91.0%	93.0%	-	
ESD-150S210DT				
I _o =1400mA	92.0%	94.0%	-	
I _o =2100mA	91.0%	93.0%	-	
ESD-150S350DT				
I _o =2450mA	91.0%	93.0%	-	
I _o =3500mA	90.0%	92.0%	-	
ESD-150S560DT				
I _o =3850mA	91.0%	93.0%	-	
I _o =5600mA	89.0%	91.0%	-	
Standby power	-	-	1.5 W	Measured at 480Vac/50Hz; Dimming off
MTBF	-	203,000 Hours	-	Measured at 480Vac input, 80%Load and 25°C ambient temperature (MIL-HDBK-217F)
Lifetime	-	99,000 Hours	-	Measured at 480Vac input, 80%Load and 70°C case temperature with I _{aux} =100mA; See lifetime vs. T _c curve for the details
Operating Case Temperature for Safety T _{c_s}	-40°C	-	+88°C	
Operating Case Temperature for Warranty T _{c_w}	-40°C	-	+75°C	Humidity: 10%RH to 95%RH
Storage Temperature	-40°C	-	+85°C	Humidity: 5%RH to 95%RH
Dimensions				With mounting ear
Inches (L × W × H)	8.70 × 2.66 × 1.56			9.53 × 2.66 × 1.56
Millimeters (L × W × H)	221 × 67.5 × 39.7			242 × 67.5 × 39.7
Net Weight	-	1300 g	-	

Dimming Specifications

Parameter		Min.	Typ.	Max.	Notes
Absolute Maximum Voltage on the Vdim (+) Pin		-20 V	-	20 V	
Source Current on Vdim (+)Pin		200 uA	300 uA	450 uA	Vdim(+) = 0 V
Dimming Output Range	ESD-150S105DT ESD-150S210DT ESD-150S350DT ESD-150S560DT	10%I _{oSet}	-	I _{oSet}	700mA ≤ I _{oSet} ≤ 1050mA 1400mA ≤ I _{oSet} ≤ 2100mA 2450mA ≤ I _{oSet} ≤ 3500mA 3850mA ≤ I _{oSet} ≤ 5600mA
	ESD-150S105DT ESD-150S210DT ESD-150S350DT ESD-150S560DT	70 mA 140 mA 245 mA 385 mA	-	I _{oSet}	70mA ≤ I _{oSet} < 700mA 140mA ≤ I _{oSet} < 1400mA 245mA ≤ I _{oSet} < 2450mA 385mA ≤ I _{oSet} < 3850mA
Recommended Dimming Input Range		0 V	-	10 V	Default 0-10V dimming mode.
Dim off Voltage		0.35 V	0.5 V	0.65 V	
Dim on Voltage		0.55 V	0.7 V	0.85 V	
Hysteresis		-	0.2 V	-	
PWM_in High Level		3 V	-	10 V	Dimming mode set to PWM in PC interface.
PWM_in Low Level		-0.3 V	-	0.6 V	
PWM_in Frequency Range		200 Hz	-	3 KHz	
PWM_in Duty Cycle		1%	-	99%	
PWM Dimming off (Positive Logic)		2%	5%	8%	
PWM Dimming on (Positive Logic)		4%	7%	10%	
PWM Dimming off (Negative Logic)		92%	95%	98%	
PWM Dimming on (Negative Logic)		90%	93%	96%	
Hysteresis		-	2%	-	

Safety & EMC Compliance

Safety Category	Standard
UL/CUL	UL 8750,CAN/CSA-C22.2 No. 250.13
CE	EN 61347-1, EN 61347-2-13
EMI Standards	Notes
EN 55015 ⁽¹⁾	Conducted emission Test & Radiated emission Test
EN 61000-3-2	Harmonic current emissions
EN 61000-3-3	Voltage fluctuations & flicker

Safety & EMC Compliance (Continued)

EMI Standards	Notes
FCC Part15 ⁽¹⁾	ANSI C63.4 Class B
	This device complies with Part 15 of the FCC Rules. Operation is subject to the following two conditions: [1] this device may not cause harmful interference, and [2] this device must accept any interference received, including interference that may cause undesired operation.
EMS Standards	Notes
EN 61000-4-2	Electrostatic Discharge (ESD): 8kV air discharge, 4kV contact discharge
EN 61000-4-3	Radio-Frequency Electromagnetic Field Susceptibility Test-RS
EN 61000-4-4	Electrical Fast Transient / Burst-EFT
EN 61000-4-5	Surge Immunity Test: AC Power Line: Differential Mode 6kV, Common Mode 10kV ⁽²⁾
EN 61000-4-6	Conducted Radio Frequency Disturbances Test-CS
EN 61000-4-8	Power Frequency Magnetic Field Test
EN 61000-4-11	Voltage Dips
EN 61547	Electromagnetic Immunity Requirements Applies To Lighting Equipment

Note: (1) This LED driver meets the EMI specifications above, but EMI performance of a luminaire that contains it depends also on the other devices connected to the driver and on the fixture itself.

(2) To perform electric strength (hi-pot) testing, the “GDT ground disconnect” (nut and metal lock sheet) on the driver end-cap should be removed temporarily to prevent the internal gas discharge tube from conducting (as allowed by IEC 60598-1 Clause 10.2). After testing is completed, these items must be reinstalled to restore line-to-earth surge protection and secure the end cap.

Lifetime vs. Case Temperature

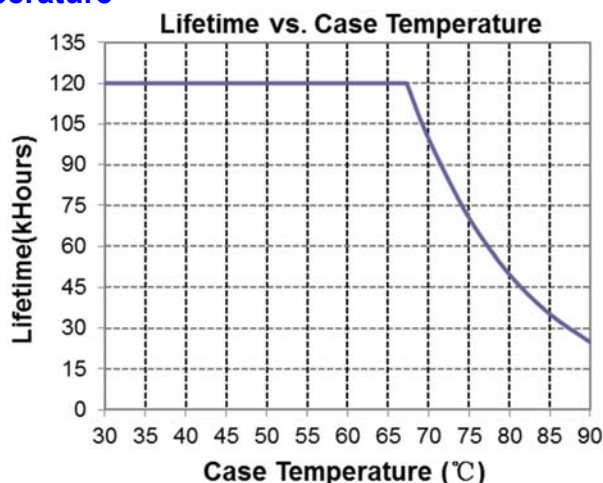

Inrush Current Waveform

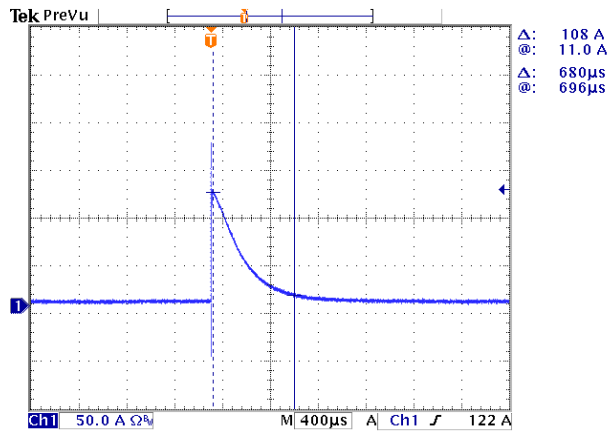

Efficiency vs. Load

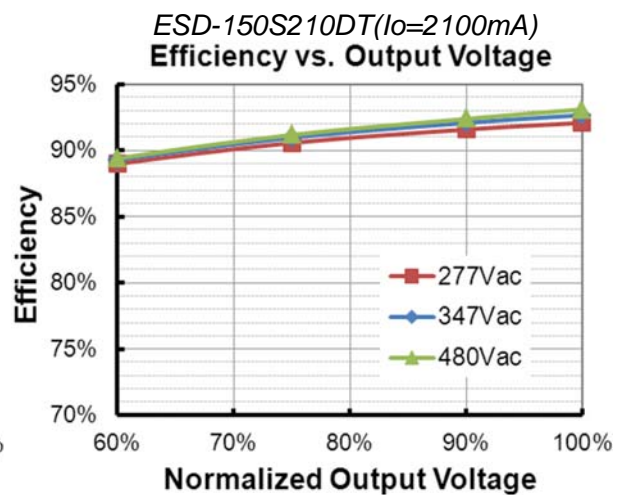
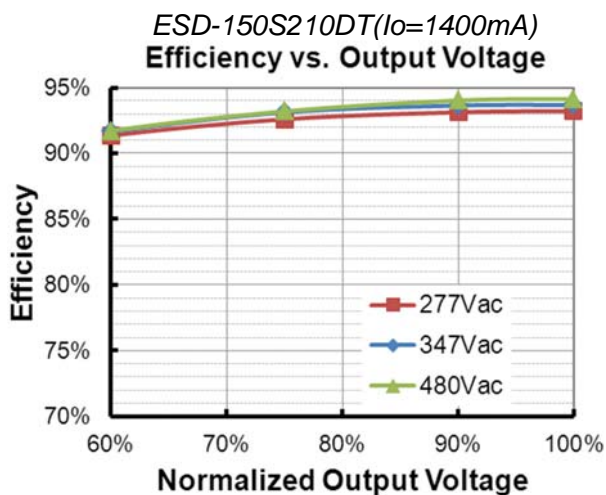
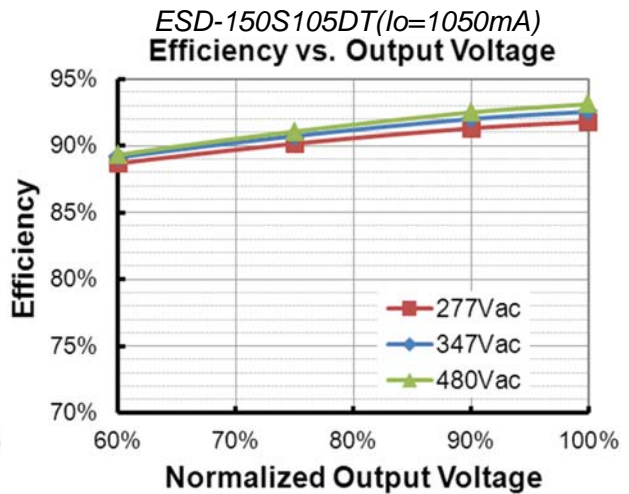
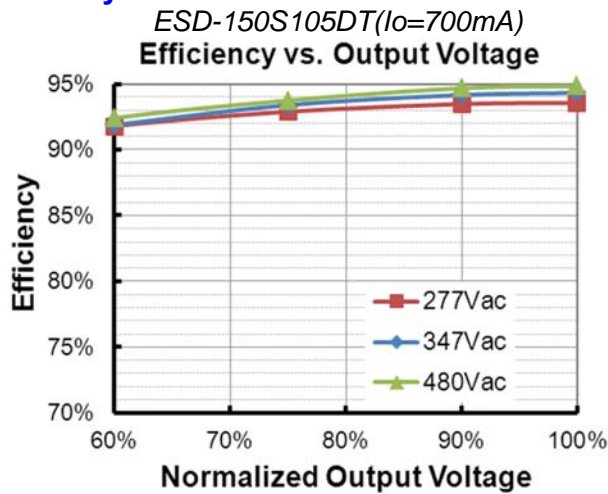

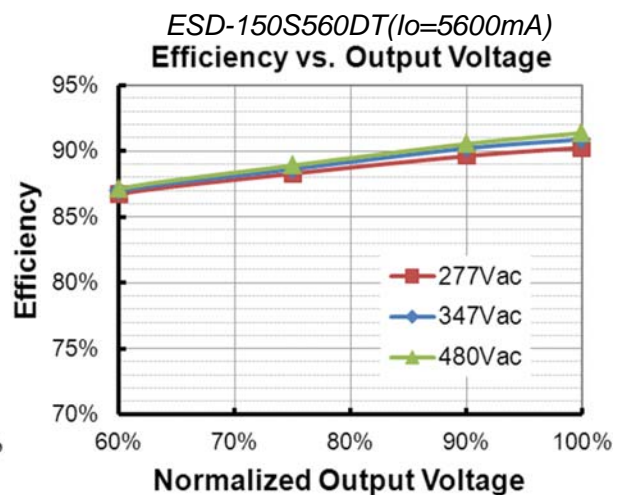
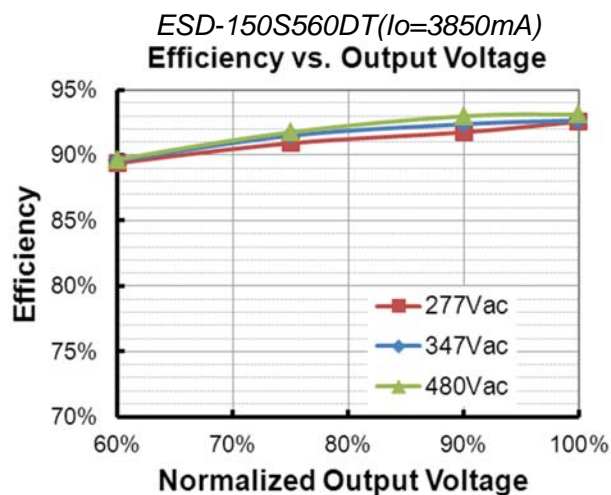
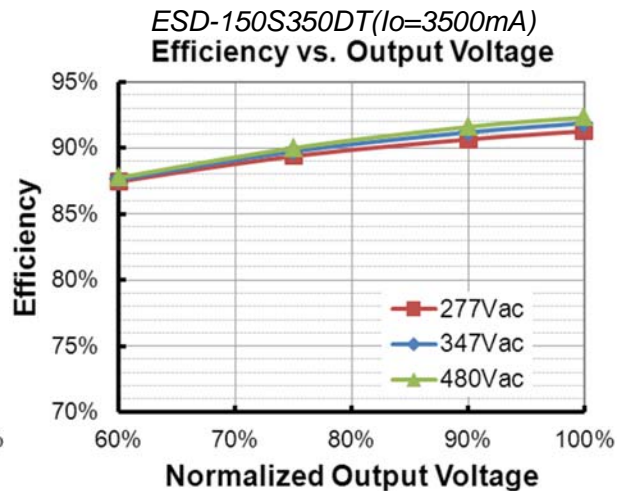
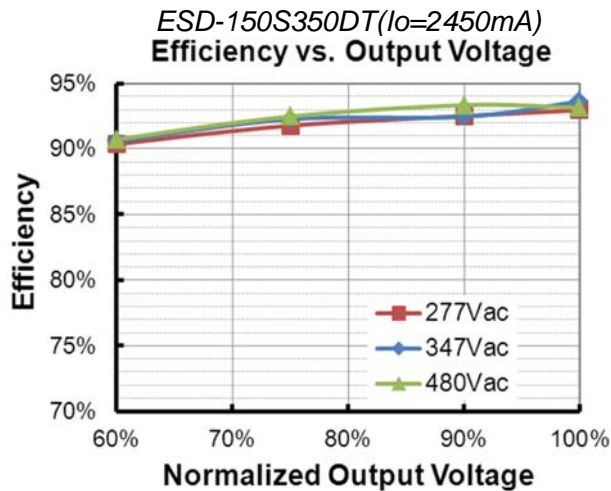

Power Factor

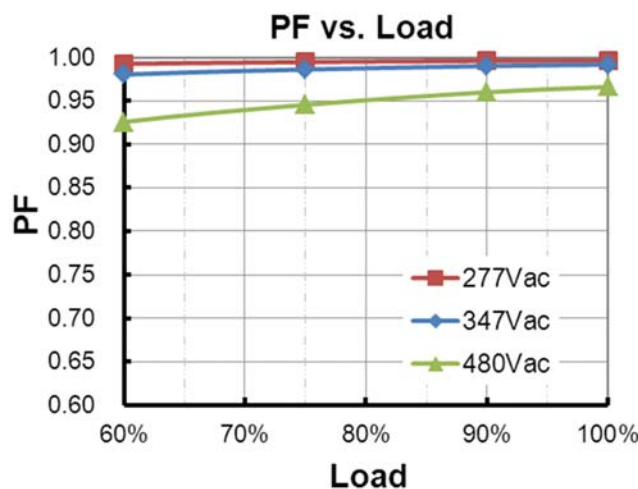

Total Harmonic Distortion

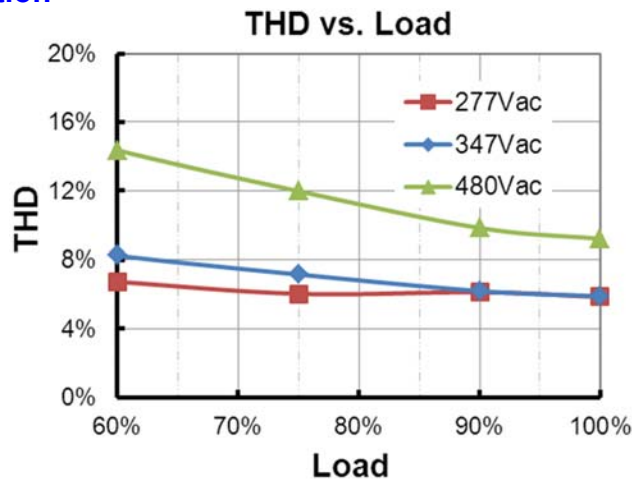

Protection Functions

Parameter		Notes			
Over Temperature Protection		Decreases output current, returning to normal after over temperature is removed.			
Short Circuit Protection		Auto Recovery. No damage will occur when any output is short circuited. The output shall return to normal when the fault condition is removed.			
Over Voltage Protection		Limits output voltage at no load and in case the normal voltage limit fails.			
External Thermal Protection NTC	R1	-	7.81 kOhm	-	When R_NTC falls below R1, External Thermal Protection is triggered, reducing output current until R2 is reached.
	R2	-	4.16 kOhm	-	When R_NTC is less than R2, output current is reduced to the programmed "Protection Current Floor."
	Protection Current Setting Range	10%loset	60%loset	100%loset	10%loset > I _{omin} (default setting is 60%)
I _{omin}		60%loset	100%loset	10%loset ≤ I _{omin} (default setting is 60%)	

Dimming

● 0-10V Dimming

The recommended implementation of the dimming control is provided below.

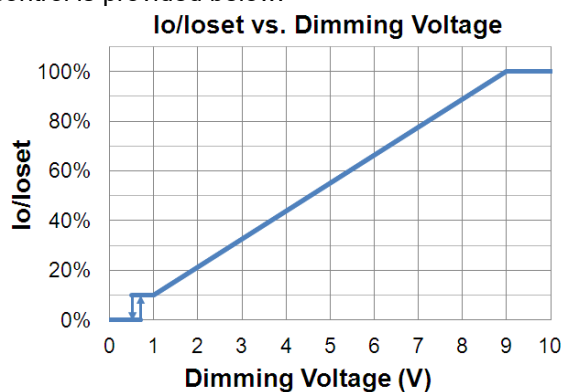
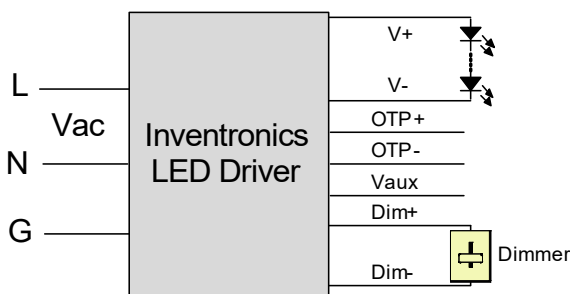

Implementation 1: DC Input

Notes:

1. Do NOT connect Dim- to the output V- or V+, otherwise the driver will not work properly.
2. The dimmer can also be replaced by an active 0-10V voltage source signal or passive components like zener.

● **PWM Dimming**

The recommended implementation of the dimming control is provided below.

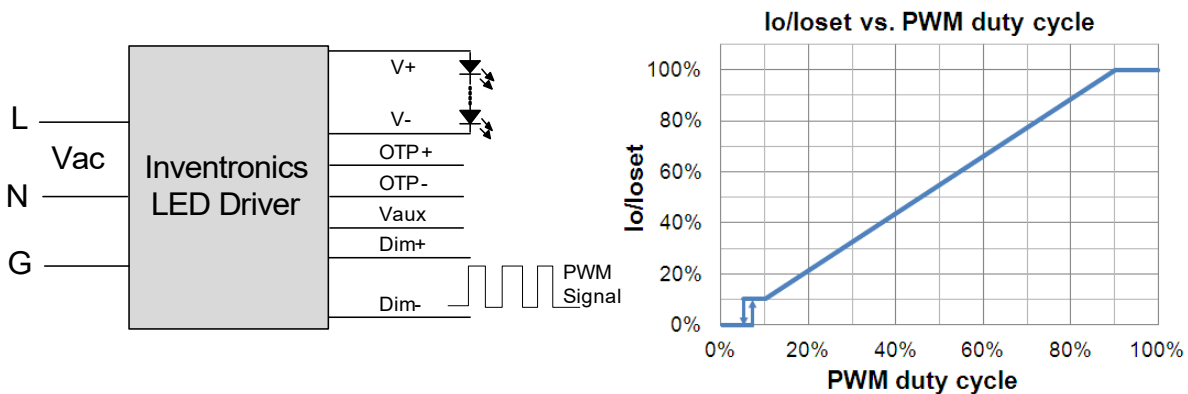

Implementation 2: Positive logic

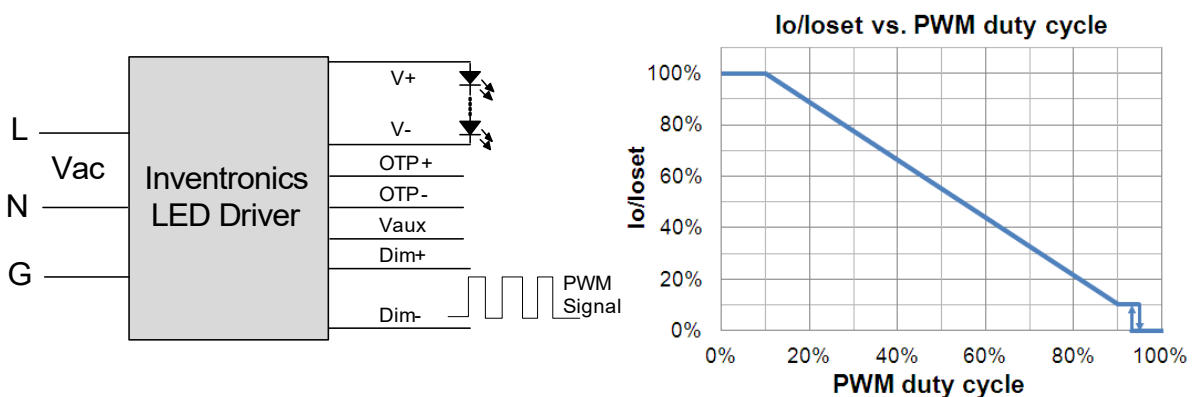

Implementation 3: Negative logic

Notes:

1. Do NOT connect Dim- to the output V- or V+, otherwise the driver will not work properly.
2. When PWM negative logic dimming mode and Dim+ is open, the driver will dim to off and be standby.

● **Time Dimming**

Time dimming control includes 3 kinds of modes, they are Self Adapting-Midnight, Self Adapting-Percentage and Traditional Timer.

- **Self Adapting-Midnight:** Automatically adjusts the dimming curve based on the on-time of past two days (if difference <15 minutes), assuming that the center point of the dimming curve is midnight local time.
- **Self Adapting-Percentage:** Automatically adjusts the on-time of each step by a constant percentage = (actual on-time for the past 2 days if difference <15 min) / (programmed on-time from the dimming curve).
- **Traditional Timer:** Follows the programmed timing curve after power on with no changes.

● **Output Lumen Compensation**

Output Lumen Compensation (OLC) may be used to maintain constant light output over the life of the LEDs by driving them at a reduced current when new, then gradually increasing the drive current over time to counteract LED lumen degradation.

Programming Connection Diagram

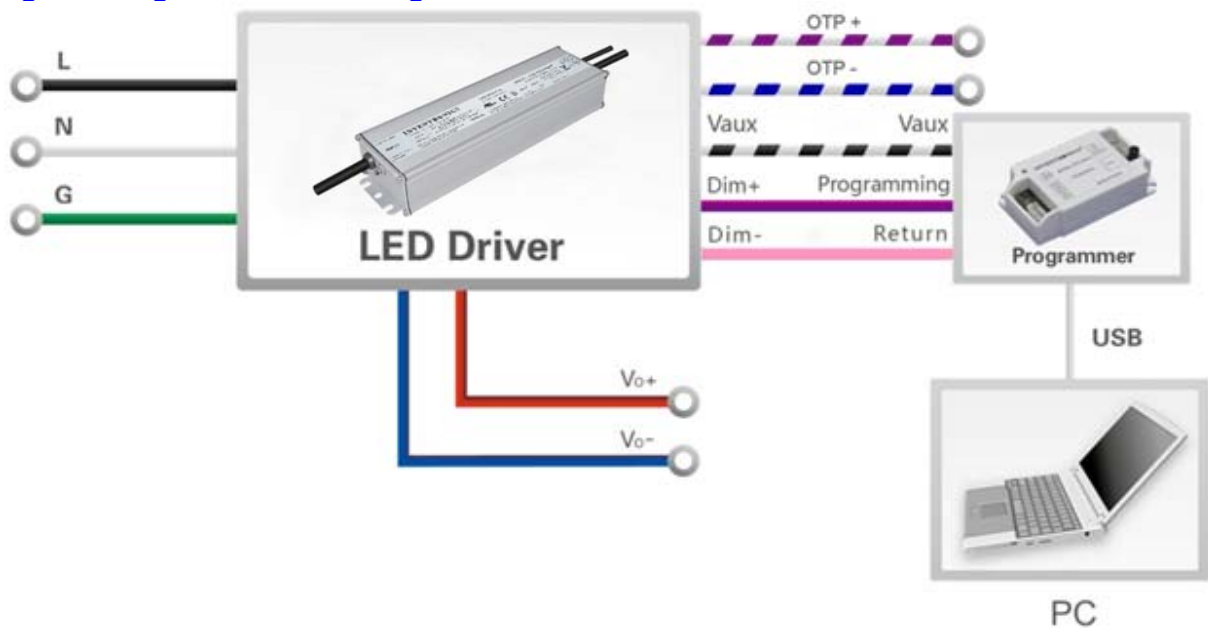

Note: The driver does not need to be powered on during the programming process.

● Please refer to [PRG-MUL2](#) Multi-Programmer datasheet for details.

Mechanical Outline

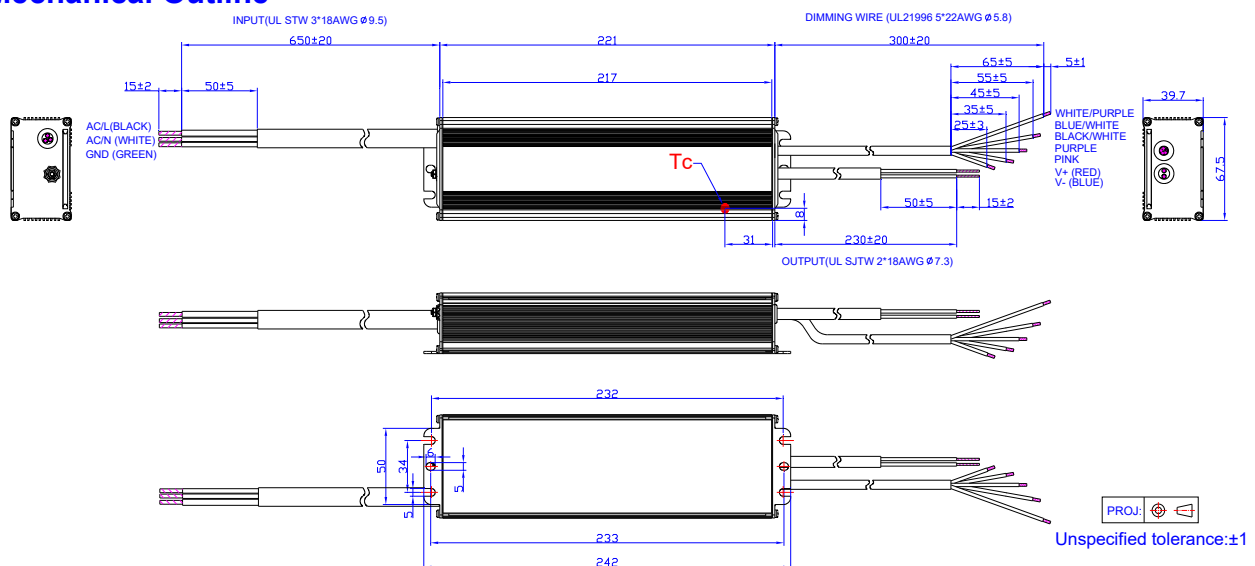

RoHS Compliance

Our products comply with reference to RoHS Directive (EU) 2015/863 amending 2011/65/EU, calling for the elimination of lead and other hazardous substances from electronic products.

Revision History

Change Date	Rev.	Description of Change		
		Item	From	To
2015-09-23	A	Datasheets Release	/	/
2016-06-02	B	Input AC Current	/	Updated
		General Specifications	With mounting ear	Added
		General Specifications	Net Weight	Added
		Safety & EMC Compliance	Notes	Added
		Programming Connection Diagram	/	Updated
		Mechanical Outline	/	Updated
2017-08-03	C	Features	/	Updated
		Input Specifications	PF/THD	Updated
		Output Specifications	Turn-on Delay Time	Updated
		Output Specifications	Temperature Coefficient of I _{oset}	Updated
		Safety & EMC Compliance	/	Updated
		Mechanical Outline	/	Updated
2019-06-26	D	CE	/	Updated
		Features	/	Updated
		Description	/	Updated
		Models	/	Updated
		Input Specifications	Input Voltage	Updated
		Input Specifications	Leakage Current	Updated
		Output Specifications	Turn-on Delay Time	Updated
		General Specifications	Lifetime	Updated
		Safety & EMC Compliance	/	Updated
		Lifetime vs. Case Temperature	/	Updated
		Mechanical Outline	/	Updated

Revision History (Continued)

Change Date	Rev.	Description of Change		
		Item	From	To
2022-03-10	E	Product Photograph	/	Updated
		Features	/	Updated
		General Specifications	Humidity	Updated
		Dimming	/	Updated
		Programming Connection Diagram	/	Updated
		Mechanical Outline	/	Updated
		RoHS Compliance	/	Updated