

Features

- Ultra High Efficiency (Up to 94%)
- Full Power at Wide Output Current Range (Constant Power)
- 0-10V/PWM/Timer Dimmable
- Dim-to-Off with Standby Power ≤ 1.5 W
- Input Surge Protection: DM 4kV, CM 6kV
- All-Around Protection: OVP, SCP, OTP
- IP67 and UL Dry / Damp / Wet Location
- SELV Output
- TYPE HL, for use in a Class I, Division 2 hazardous (Classified) location
- 5 Years Warranty



Description

The ESD-240SxxxDT series is a 240W, constant-current, programmable LED driver that operates from 249-528 Vac input with excellent power factor. Created for many lighting applications including high bay, high mast, sports and roadway, it provides a dim-to-off mode with low standby power. The high efficiency of these drivers and compact metal case enables them to run cooler, significantly improving reliability and extending product life. To ensure trouble-free operation, protection is provided against over voltage, short circuit, and over temperature.

Models

Adjustable Output Current Range	Full-Power Current Range (1)	Default Output Current	Input Voltage Range(2)	Output Voltage Range	Max. Output Power	Typical Efficiency (3)	Typical Power Factor		Model Number
							277Vac	480Vac	
70-1000mA	700-1000mA	700 mA	249~528 Vac 352~500 Vdc	120~343Vdc	240 W	94.0%	0.96	0.95	ESD-240S100DT
105-1500mA	1050-1500mA	1400 mA	249~528 Vac 352~500 Vdc	80~229Vdc	240 W	93.5%	0.96	0.95	ESD-240S150DT
154-2200mA	1540-2200mA	2100 mA	249~528 Vac 352~500 Vdc	55~156Vdc	240 W	93.0%	0.96	0.95	ESD-240S220DT
224-3200mA	2240-3200mA	2800 mA	249~528 Vac 352~500 Vdc	38~107Vdc	240 W	93.0%	0.96	0.95	ESD-240S320DT ⁽⁴⁾
322-4600mA	3220-4600mA	4200 mA	249~528 Vac 352~500 Vdc	27~75Vdc	240 W	93.0%	0.96	0.95	ESD-240S460DT ⁽⁴⁾
462-6600mA	4620-6600mA	4900 mA	249~528 Vac 352~500 Vdc	19~52Vdc	240 W	92.5%	0.96	0.95	ESD-240S660DT ⁽⁴⁾

- Notes:** (1) Output current range with constant power at 240W
 (2) Certified voltage range: 277-480Vac or 352-500Vdc
 (3) Measured at 100% load and 480Vac input (see below "General Specifications" for details).
 (4) SELV Output

I-V Operating Area

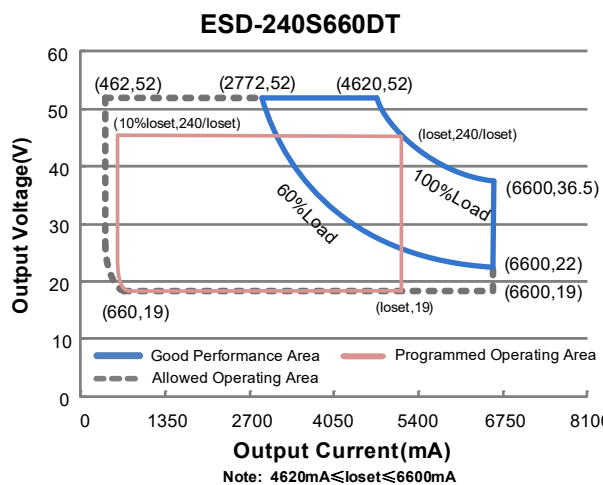
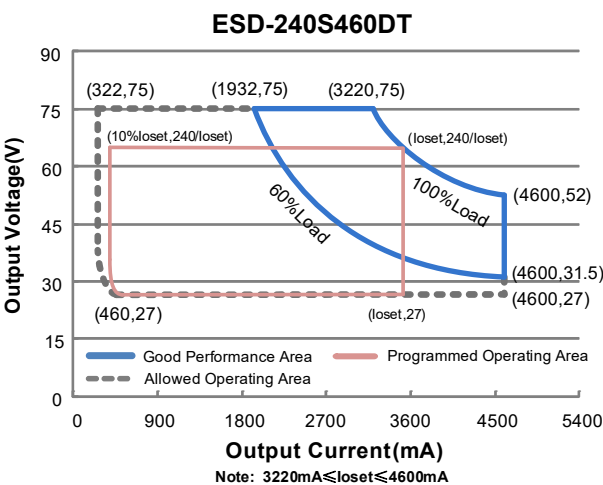
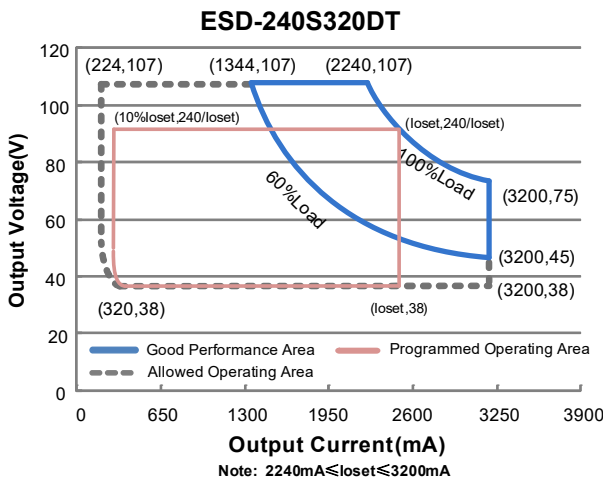
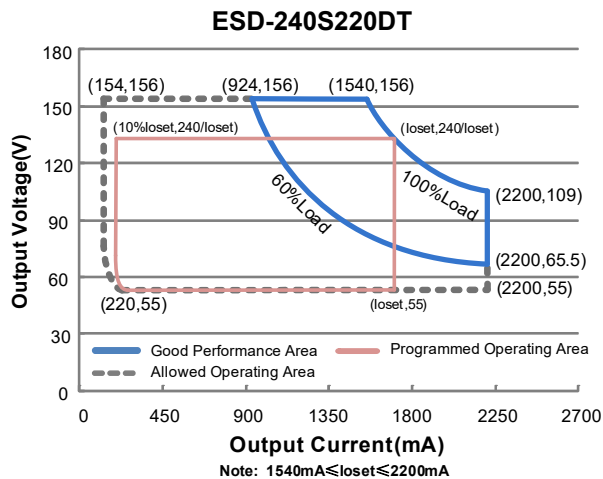
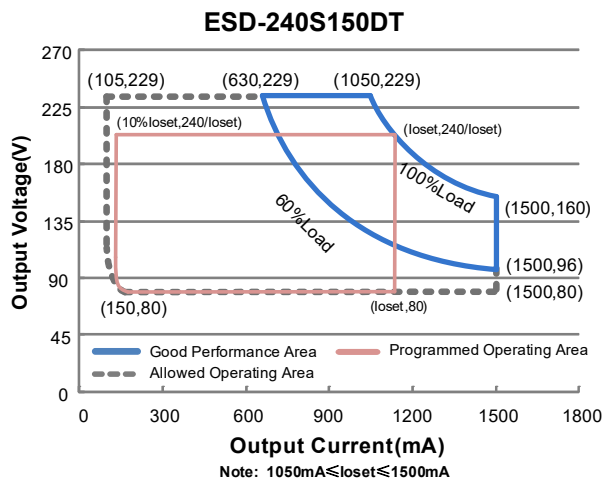
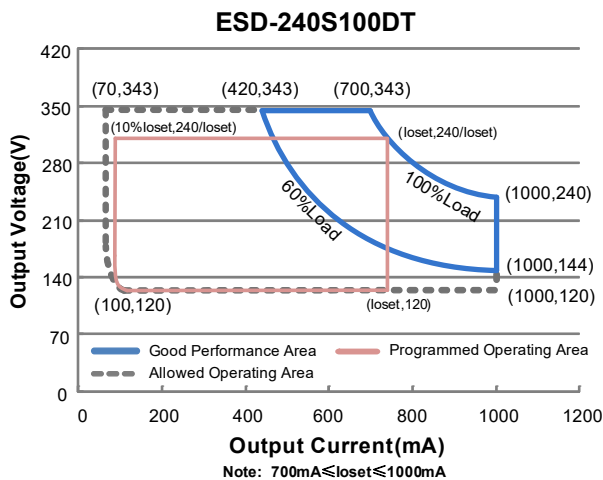

Input Specifications

Parameter	Min.	Typ.	Max.	Notes
Input AC Voltage	249 Vac	-	528 Vac	
Input DC Voltage	352 Vdc	-	500 Vdc	
Input Frequency	47 Hz	-	63 Hz	
Leakage Current	-	-	0.75 MIU	UL8750; 480Vac/ 60Hz
	-	-	0.70 mA	IEC60598-1; 480Vac/ 60Hz
Input AC Current	-	-	1.1 A	Measured at 100% load and 277 Vac input.
	-	-	0.6 A	Measured at 100% load and 480 Vac input.
Inrush Current(I ² t)	-	-	2.9 A ² s	At 480Vac input, 25°C Cold Start, Duration=1.43 ms, 10%Ipk-10%Ipk. See Inrush Current Waveform for the details.
PF	0.90	-	-	At 277-480Vac, 50-60Hz, 60%-100% Load (144-240W)
THD	-	-	20%	

Output Specifications

Parameter	Min.	Typ.	Max.	Notes
Output Current Tolerance	-5%loset	-	5%loset	100% load
Output Current Setting(loset) Range				
ESD-240S100DT	70 mA	-	1000 mA	
ESD-240S150DT	105 mA	-	1500 mA	
ESD-240S220DT	154 mA	-	2200 mA	
ESD-240S320DT	224 mA	-	3200 mA	
ESD-240S460DT	322 mA	-	4600 mA	
ESD-240S660DT	462 mA	-	6600 mA	
Output Current Setting Range with Constant Power				
ESD-240S100DT	700 mA	-	1000 mA	
ESD-240S150DT	1050 mA	-	1500 mA	
ESD-240S220DT	1540 mA	-	2200 mA	
ESD-240S320DT	2240 mA	-	3200 mA	
ESD-240S460DT	3220 mA	-	4600 mA	
ESD-240S660DT	4620 mA	-	6600 mA	
Output Current Ripple(pk-pk)	-	5%Iomax	10%Iomax	100% load
Startup Overshoot Current	-	-	10%Iomax	100% load
No Load Output Voltage				
ESD-240S100DT	-	-	355 V	
ESD-240S150DT	-	-	248 V	
ESD-240S220DT	-	-	170 V	
ESD-240S320DT	-	-	120 V	
ESD-240S460DT	-	-	90 V	
ESD-240S660DT	-	-	60 V	
Line Regulation	-	-	±0.5%	Measured at 100% load
Load Regulation	-	-	±1.5%	

Output Specifications (Continued)

Parameter	Min.	Typ.	Max.	Notes
Turn-on Delay Time	-	0.5 s	0.75 s	Measured at 277Vac and 480Vac input, 60%-100% Load
Temperature Coefficient of I _o set	-	0.03%/°C	-	Case temperature = 0°C ~T _c max
12V Auxiliary Output Voltage	10.8 V	12 V	13.2 V	
12V Auxiliary Output Source Current	0 mA	-	200 mA	Return terminal is "Dim"

General Specifications

Parameter	Min.	Typ.	Max.	Notes
Efficiency at 277 Vac input:				
ESD-240S100DT				
I _o = 700mA	90.0%	92.0%	-	
I _o =1000mA	89.5%	91.5%	-	
ESD-240S150DT				
I _o =1050mA	90.0%	92.0%	-	
I _o =1500mA	89.0%	91.0%	-	
ESD-240S220DT				
I _o =1540mA	89.5%	91.5%	-	Measured at 100% load and steady-state temperature in 25°C ambient; (Efficiency will be about 2.0% lower if measured immediately after startup.)
I _o =2200mA	89.5%	91.5%	-	
ESD-240S320DT				
I _o =2240mA	89.5%	91.5%	-	
I _o =3200mA	88.5%	90.5%	-	
ESD-240S460DT				
I _o =3220mA	89.5%	91.5%	-	
I _o =4600mA	88.0%	90.0%	-	
ESD-240S660DT				
I _o =4620mA	89.0%	91.0%	-	
I _o =6600mA	88.0%	90.0%	-	
Efficiency at 347 Vac input:				
ESD-240S100DT				
I _o = 700mA	91.0%	93.0%	-	
I _o =1000mA	90.5%	92.5%	-	
ESD-240S150DT				
I _o =1050mA	91.0%	93.0%	-	
I _o =1500mA	90.0%	92.0%	-	
ESD-240S220DT				
I _o =1540mA	90.0%	92.0%	-	Measured at 100% load and steady-state temperature in 25°C ambient; (Efficiency will be about 2.0% lower if measured immediately after startup.)
I _o =2200mA	90.0%	92.0%	-	
ESD-240S320DT				
I _o =2240mA	90.0%	92.0%	-	
I _o =3200mA	89.5%	91.5%	-	
ESD-240S460DT				
I _o =3220mA	90.0%	92.0%	-	
I _o =4600mA	89.0%	91.0%	-	
ESD-240S660DT				
I _o =4620mA	90.0%	92.0%	-	
I _o =6600mA	89.0%	91.0%	-	

General Specifications (Continued)

Parameter	Min.	Typ.	Max.	Notes	
Efficiency at 480 Vac input: ESD-240S100DT I _o = 700mA I _o =1000mA	92.0% 91.0%	94.0% 93.0%	- -	Measured at 100% load and steady-state temperature in 25°C ambient; (Efficiency will be about 2.0% lower if measured immediately after startup.)	
ESD-240S150DT I _o =1050mA I _o =1500mA	91.5% 91.5%	93.5% 93.5%	- -		
ESD-240S220DT I _o =1540mA I _o =2200mA	91.0% 91.0%	93.0% 93.0%	- -		
ESD-240S320DT I _o =2240mA I _o =3200mA	91.0% 90.0%	93.0% 92.0%	- -		
ESD-240S460DT I _o =3220mA I _o =4600mA	91.0% 89.5%	93.0% 91.5%	- -		
ESD-240S660DT I _o =4620mA I _o =6600mA	90.5% 89.5%	92.5% 91.5%	- -		
Standby power	-	-	1.5 W		Measured at 480Vac/50Hz; Dimming off
MTBF	-	209,000 Hours	-		Measured at 480Vac input, 80%Load and 25°C ambient temperature (MIL-HDBK-217F)
Lifetime	-	114,000 Hours	-		Measured at 480Vac input, 80%Load and 70°C case temperature; See lifetime vs. Tc curve for the details
Operating Case Temperature for Safety T _{c_s}	-40°C	-	+89°C		
Operating Case Temperature for Warranty T _{c_w}	-40°C	-	+75°C	Case temperature for 5 years warranty Humidity: 10% RH to 95% RH	
Storage Temperature	-40°C	-	+85°C	Humidity: 5% RH to 95% RH	
Dimensions Inches (L × W × H) Millimeters (L × W × H)	9.49 × 2.66 × 1.56 241 × 67.5 × 39.7			With mounting ear 10.32 × 2.66 × 1.56 262 × 67.5 × 39.7	
Net Weight	-	1400 g	-		

Dimming Specifications

Parameter	Min.	Typ.	Max.	Notes
Absolute Maximum Voltage on the V _{dim} (+) Pin	-20 V	-	20 V	
Source Current on V _{dim} (+)Pin	200 uA	300 uA	450 uA	V _{dim} (+) = 0 V
Dimming Output Range	10%I _o set	-	I _o set	700mA ≤ I _o set ≤ 1000mA 1050mA ≤ I _o set ≤ 1500mA 1540mA ≤ I _o set ≤ 2200mA 2240mA ≤ I _o set ≤ 3200mA 3220mA ≤ I _o set ≤ 4600mA 4620mA ≤ I _o set ≤ 6600mA

Dimming Specifications (Continued)

Parameter		Min.	Typ.	Max.	Notes
Dimming Output Range	ESD-240S100DT	70 mA	-	loset	$70\text{mA} \leq \text{loset} < 700\text{mA}$
	ESD-240S150DT	105 mA			$105\text{mA} \leq \text{loset} < 1050\text{mA}$
	ESD-240S220DT	154 mA			$154\text{mA} \leq \text{loset} < 1540\text{mA}$
	ESD-240S320DT	224 mA			$224\text{mA} \leq \text{loset} < 2240\text{mA}$
	ESD-240S460DT	322 mA			$322\text{mA} \leq \text{loset} < 3220\text{mA}$
	ESD-240S660DT	462 mA			$462\text{mA} \leq \text{loset} < 4620\text{mA}$
Recommended Dimming Input Range		0 V	-	10 V	Default 0-10V dimming mode.
Dim off Voltage		0.2 V	0.4 V	0.6 V	
Dim on Voltage		0.4 V	0.6 V	0.8 V	
Hysteresis		-	0.2 V	-	
PWM_in High Level		3 V	-	10 V	Dimming mode set to PWM in PC interface.
PWM_in Low Level		-0.3 V	-	0.6 V	
PWM_in Frequency Range		200 Hz	-	3 KHz	
PWM_in Duty Cycle		1%	-	99%	
PWM Dimming off (Positive Logic)		2%	4%	7%	
PWM Dimming on (Positive Logic)		4%	6%	9%	
PWM Dimming off (Negative Logic)		93%	96%	98%	
PWM Dimming on (Negative Logic)		91%	94%	96%	
Hysteresis		-	2%	-	

Safety & EMC Compliance

Safety Category	Standard
UL/CUL	UL8750,CAN/CSA-C22.2 No. 250.13
CE	EN 61347-1, EN 61347-2-13
EMI Standards	Notes
EN 55015 ⁽¹⁾	Conducted emission Test & Radiated emission Test
EN 61000-3-2	Harmonic current emissions
EN 61000-3-3	Voltage fluctuations & flicker
FCC Part 15 ⁽¹⁾	ANSI C63.4 Class B
	This device complies with Part 15 of the FCC Rules. Operation is subject to the following two conditions: [1] this device may not cause harmful interference, and (2) this device must accept any interference received, including interference that may cause undesired Operation.

Safety & EMC Compliance (Continued)

EMS Standards	Notes
EN 61000-4-2	Electrostatic Discharge (ESD): 8 kV air discharge, 4 kV contact discharge
EN 61000-4-3	Radio-Frequency Electromagnetic Field Susceptibility Test-RS
EN 61000-4-4	Electrical Fast Transient / Burst-EFT
EN 61000-4-5	Surge Immunity Test: AC Power Line: Differential Mode 4 kV, Common Mode 6 kV ⁽²⁾
EN 61000-4-6	Conducted Radio Frequency Disturbances Test-CS
EN 61000-4-8	Power Frequency Magnetic Field Test
EN 61000-4-11	Voltage Dips
EN 61547	Electromagnetic Immunity Requirements Applies To Lighting Equipment

- Notes:** (1) This LED driver meets the EMI specifications above, but EMI performance of a luminaire that contains it depends also on the other devices connected to the driver and on the fixture itself.
- (2) To perform electric strength (hi-pot) testing, the “GDT ground disconnect” (nut and metal lock sheet) on the driver end-cap should be removed temporarily to prevent the internal gas discharge tube from conducting (as allowed by IEC 60598-1 Clause 10.2). After testing is completed, these items must be reinstalled to restore line-to-earth surge protection and secure the end cap.

Lifetime vs. Case Temperature

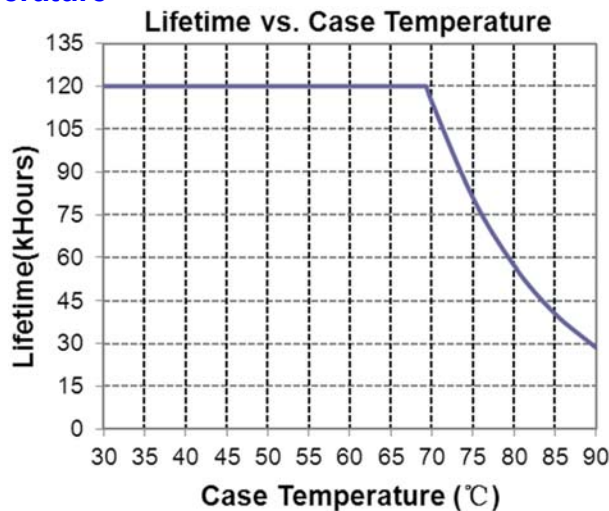

Inrush Current Waveform

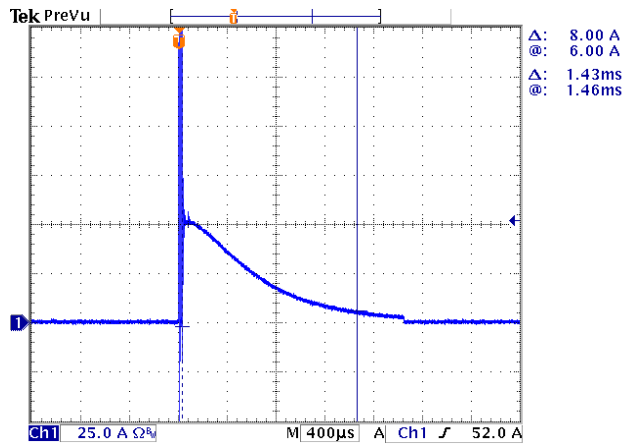

Efficiency vs. Load

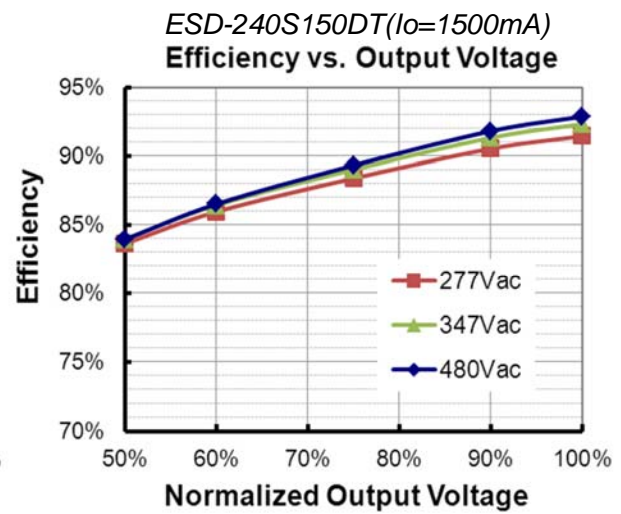
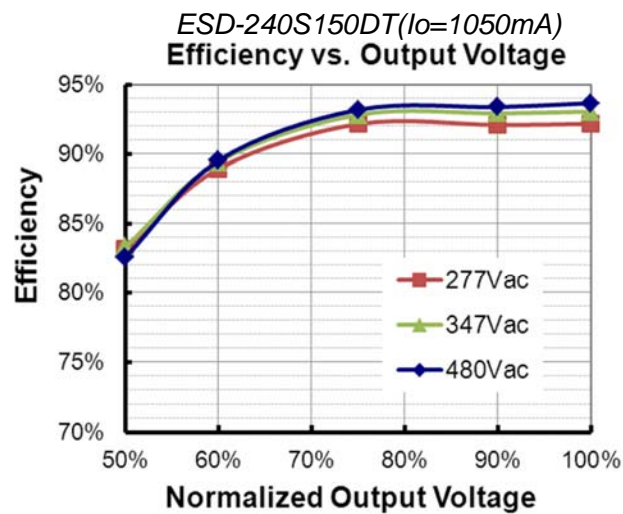
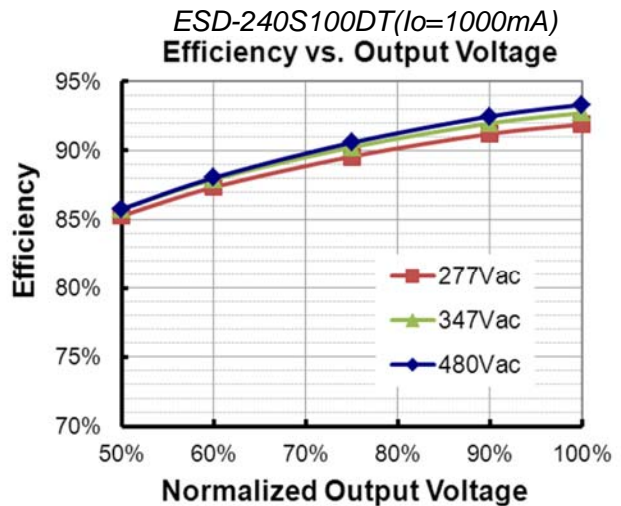
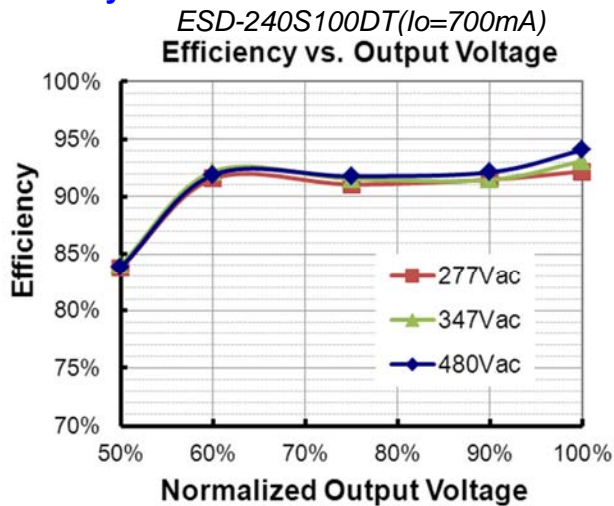

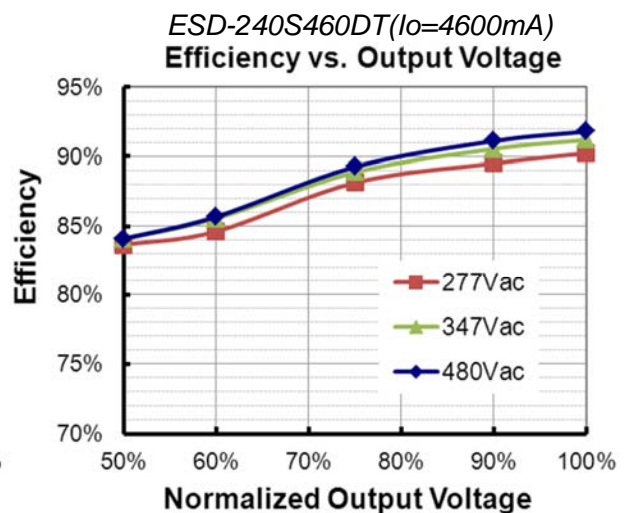
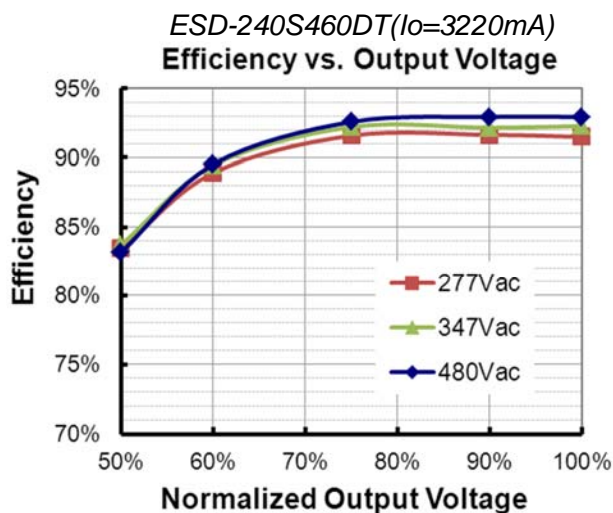
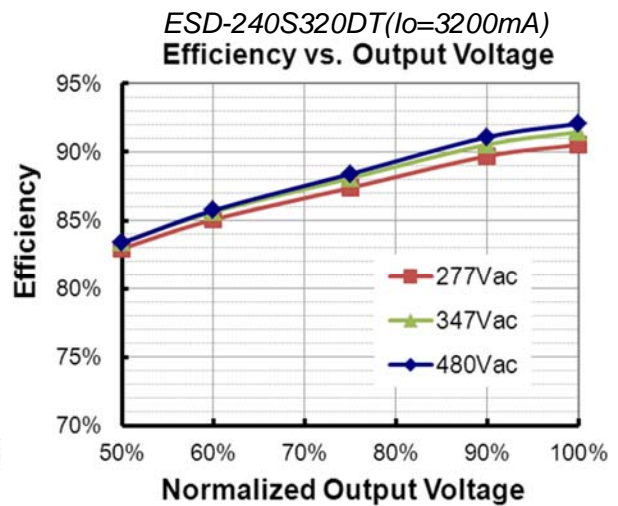
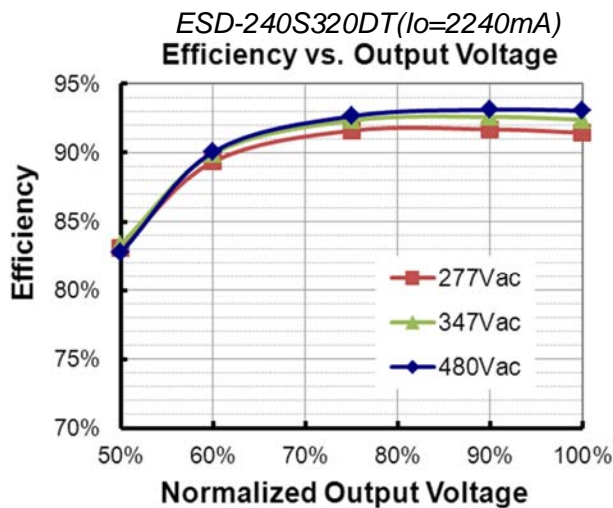
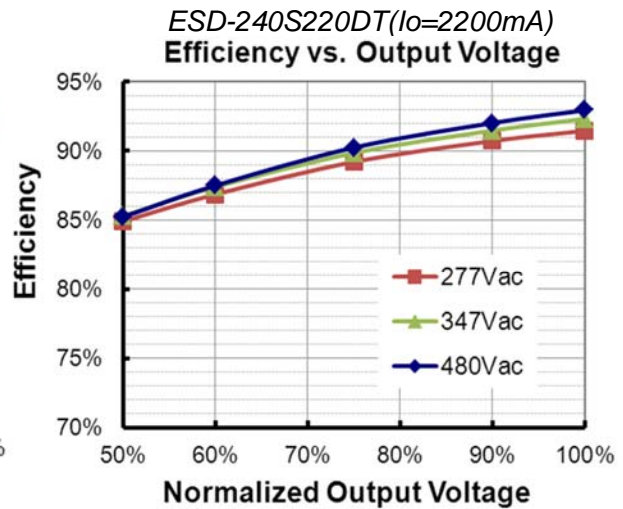
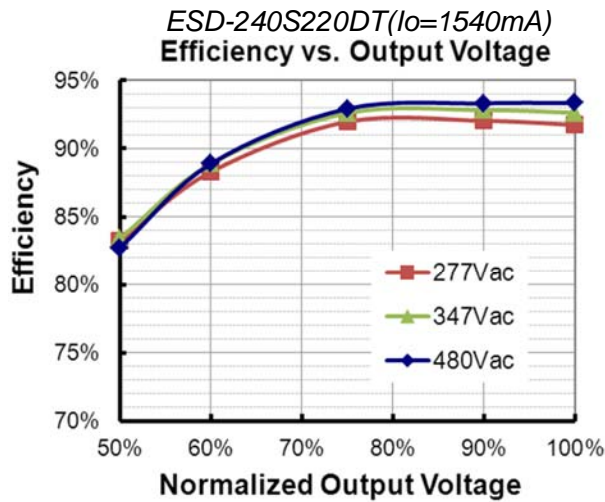

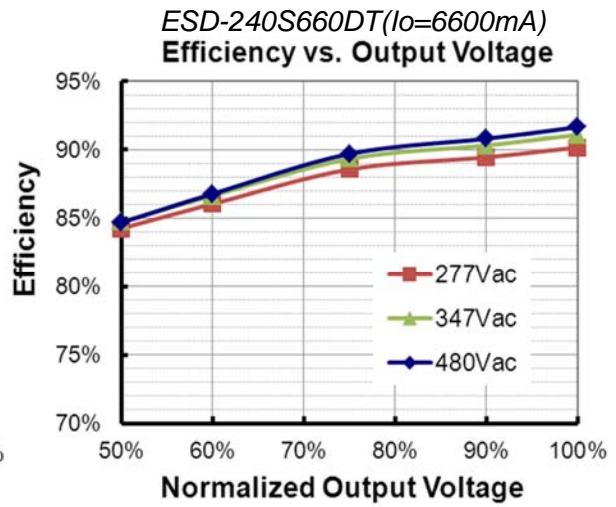
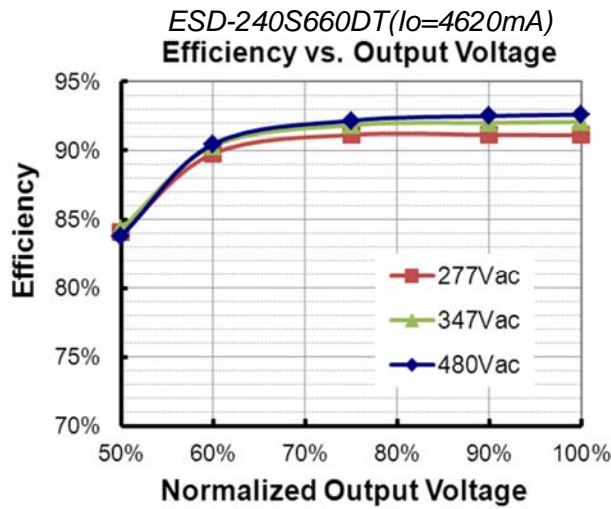

Power Factor

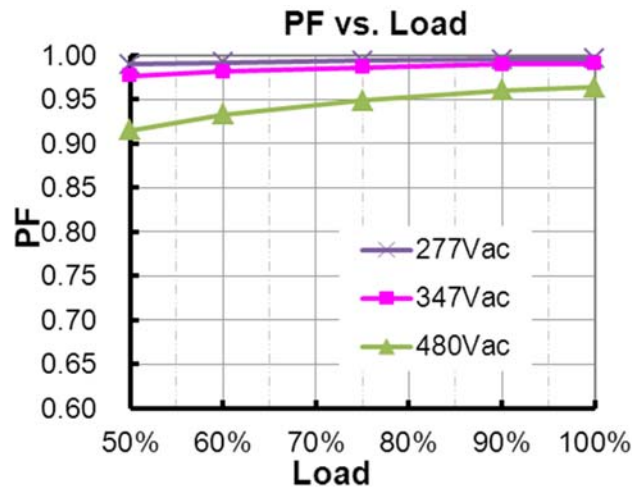

Total Harmonic Distortion

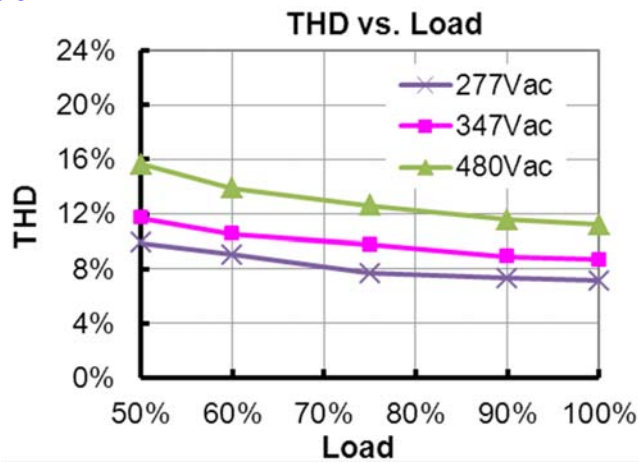

Protection Functions

Parameter	Notes
Over Temperature Protection	Decreases output current, returning to normal after over temperature is removed.
Short Circuit Protection	Auto Recovery. No damage will occur when any output is short circuited. The output shall return to normal when the fault condition is removed.
Over Voltage Protection	Limits output voltage at no load and in case the normal voltage limit fails.

Dimming

● 0-10V Dimming

The recommended implementation of the dimming control is provided below.

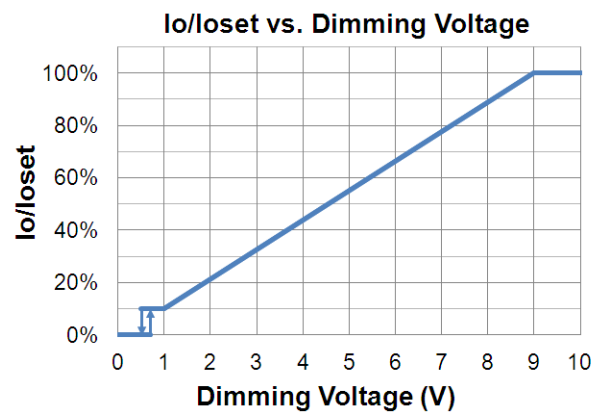
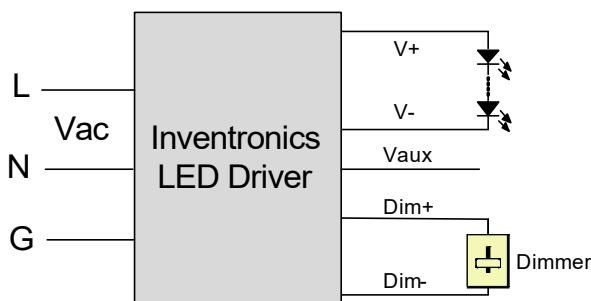

Implementation 1: DC Input

Notes:

1. Do NOT connect Dim- to the output V- or V+, otherwise the driver will not work properly.
2. The dimmer can also be replaced by an active 0-10V voltage source signal or passive components like zener.

● PWM Dimming

The recommended implementation of the dimming control is provided below.

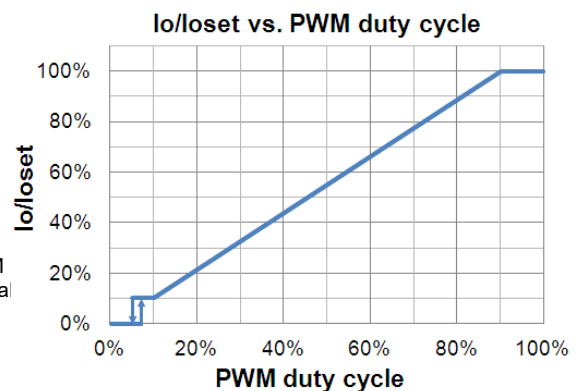
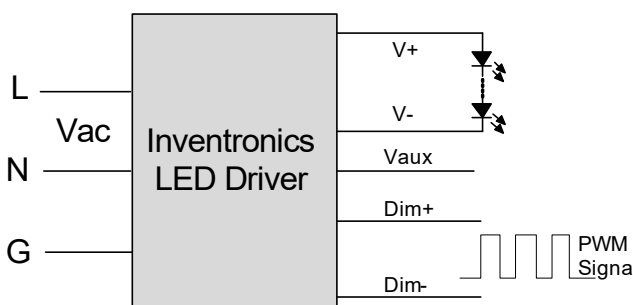

Implementation 2: Positive logic

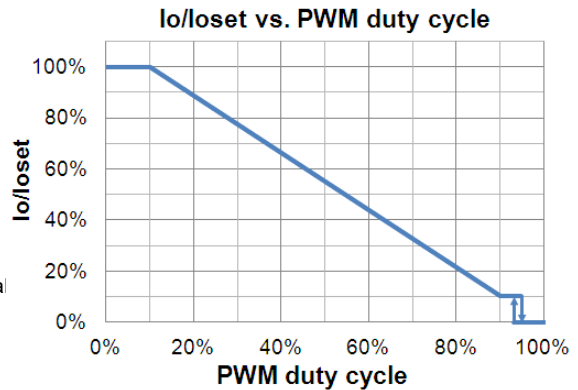
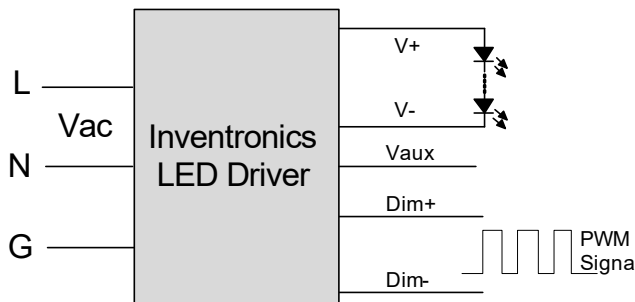

Implementation 3: Negative logic

Notes:

1. Do NOT connect Dim- to the output V- or V+, otherwise the driver will not work properly.
2. When PWM negative logic dimming mode and Dim+ is open, the driver will dim to off and be standby.

● Time Dimming

Set the timing curve by pulling the sliders.

Programming Connection Diagram

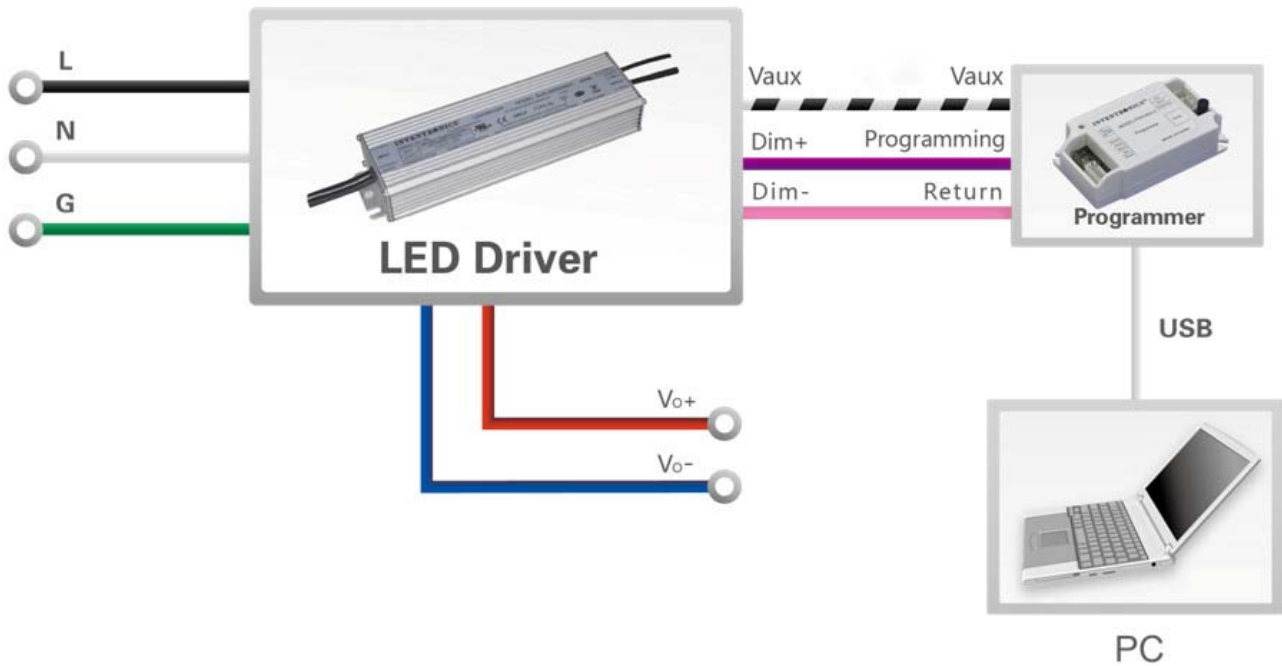

Note: The driver does not need to be powered on during the programming process.

- Please refer to [PRG-MUL2 \(Programmer\) datasheet](#) for details.

Mechanical Outline

ESD-240S100DT

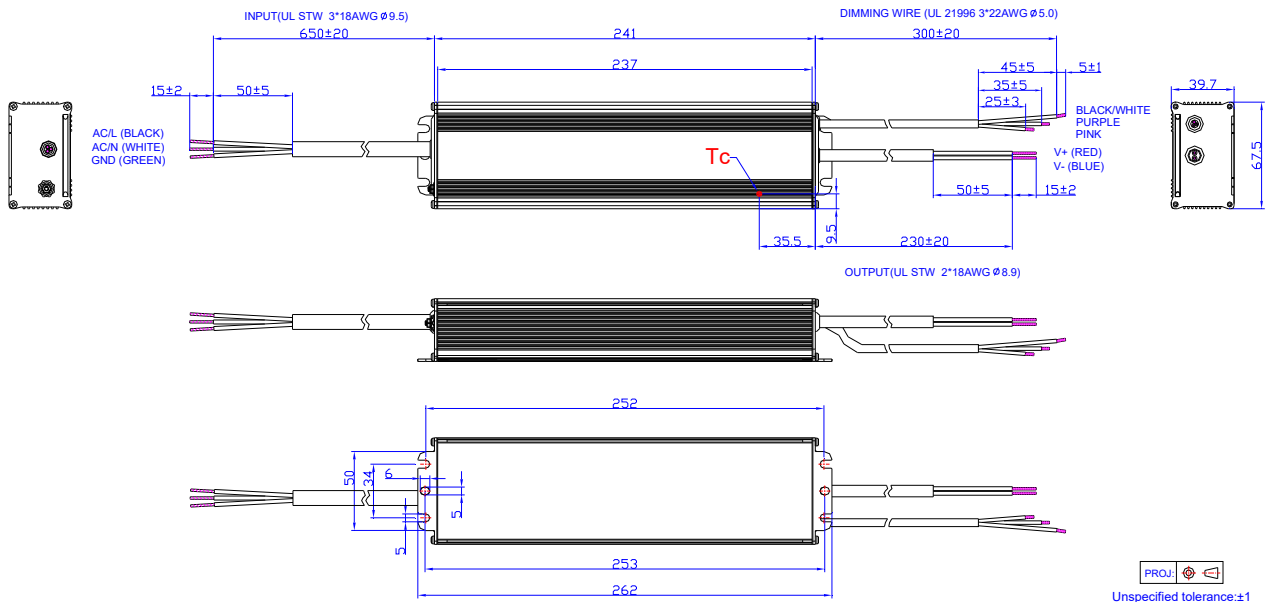

Other Models

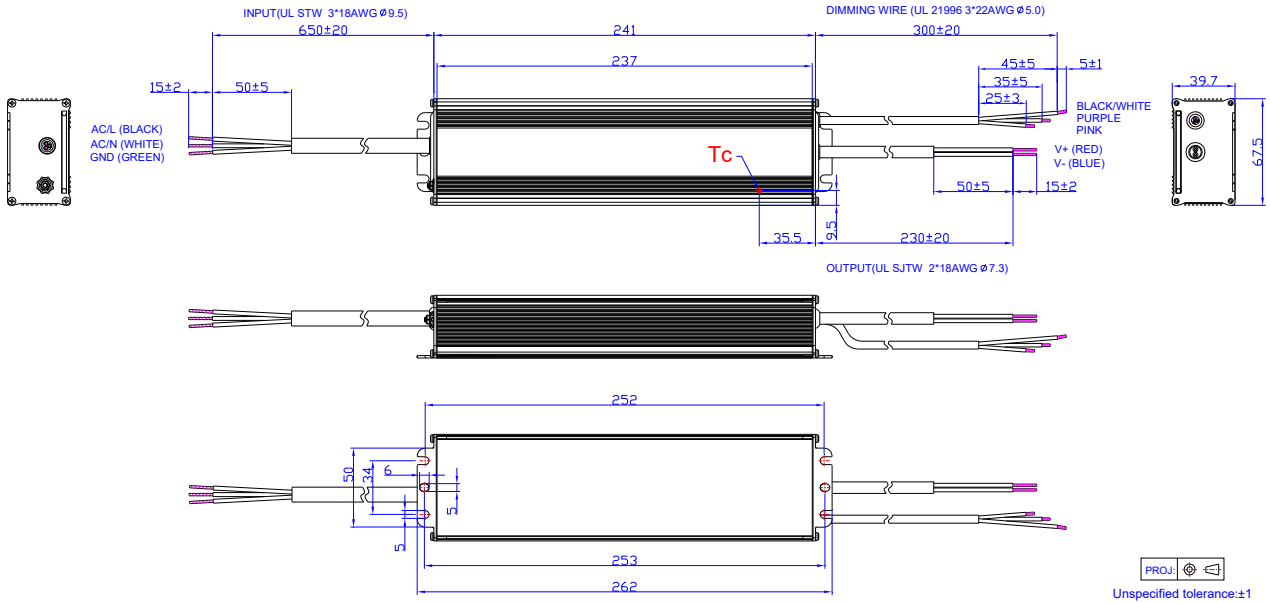

RoHS Compliance

Our products comply with reference to RoHS Directive (EU) 2015/863 amending 2011/65/EU, calling for the elimination of lead and other hazardous substances from electronic products.

Revision History

Change Date	Rev.	Description of Change		
		Item	From	To
2014-09-10	A	Datasheets Release	/	/
2016-5-30	B	General Specifications	Case Temperature	Operating Case Temperature for Safety
		General Specifications	Operating Case Temperature for Warranty Tc_w	Added
		General Specifications	Storage Temperature	Added
		General Specifications	With mounting ear	Added
		General Specifications	Net Weight	Added
		Environmental Specifications	/	Deleted
		Safety &EMC Compliance	Notes	Added
		Programming Connection Diagram	/	Updated
		Mechanical Outline	/	Updated
2017-11-21	C	Features	5 Years Warranty	Updated
		Input AC Current	/	Updated
		Input Specifications	Leakage Current	Updated
		Input Specifications	Inrush Current(I2t)	Updated
		Input Specifications	PF/THD(Note)	Updated
		Output Specifications	Turn-on Delay Time	Updated
		Output Specifications	Temperature Coefficient of Iset	Updated
		General Specifications	Lifetime	Updated
		General Specifications	Operating Case Temperature for Warranty Tc_w	Updated
		Safety &EMC Compliance	/	Updated
		Lifetime vs. Case Temperature	/	Updated
		Mechanical Outline	/	Updated
2018-04-26	D	UL	/	Updated
		Description	/	Updated
2018-11-28	E	CE	/	Added
		Features	/	Updated

Revision History (Continued)

Change Date	Rev.	Description of Change		
		Item	From	To
2018-11-28	E	Models	/	Updated
		I-V Operating Area	/	Updated
		Input Specifications	Leakage Current	Updated
		Output Specifications	Output Current Setting(losset) Range	Updated
		Output Specifications	Output Current Setting Range with Constant Power	Updated
		Output Specifications	Turn-on Delay Time	Updated
		General Specifications	Dimensions	Updated
		Dimming Specifications	Dimming Output Range	Updated
		Safety & EMC Compliance	/	Updated
		Derating	/	Deleted
		Mechanical Outline	/	Updated
2022-02-18	F	Product Photograph	/	Updated
		Features	/	Updated
		Safety & EMC Compliance	/	Updated
		Mechanical Outline	/	Updated