

Features

- High Efficiency (Up to 86%)
- Second Generation with Improved Performance
- Active Power Factor Correction (Typical 0.95)
- Constant Output Current
- IP66 and UL Damp Location
- Dimming Control
- All-Around Protection: OVP, SCP, OLP
- Class 2 and SELV
- UL Type TL (Temperature Limited)



Description

The EUC-026SxxxDS(PS) series operates from a 90 ~ 305 Vac input range. They are designed to be highly efficient and highly reliable. Features include over voltage protection, short circuit protection and over load protection.

Models

Output Current	Input Voltage Range(1)	Output Voltage Range	Max. Output Power	Typical Efficiency (2)	Typical Power Factor		Model Number
					120Vac	220Vac	
350 mA	90 ~ 305 Vac	38~75 Vdc	26 W	86%	0.96	0.95	EUC-026S035DS(PS) ^{(3) (6)}
450 mA	90 ~ 305 Vac	28~56 Vdc	25 W	85%	0.96	0.95	EUC-026S045DS(PS) ^{(4) (6)}
530 mA	90 ~ 305 Vac	25~49 Vdc	26 W	85%	0.96	0.95	EUC-026S053DS(PS) ^{(4) (6)}
700 mA	90 ~ 305 Vac	19~37 Vdc	26 W	85%	0.96	0.95	EUC-026S070DS(PS) ^{(5) (6) (7)}
1050 mA	90 ~ 305 Vac	13~25 Vdc	26 W	84%	0.96	0.95	EUC-026S105DS(PS) ^{(5) (6)}
1400 mA	90 ~ 305 Vac	10~19 Vdc	26 W	82%	0.96	0.95	EUC-026S140DS(PS) ^{(5) (6) (7)}
1750 mA	90 ~ 305 Vac	8 ~15 Vdc	26 W	81%	0.96	0.95	EUC-026S175DS(PS) ^{(5) (6) (7)}

Notes: (1) UL, FCC certified input voltage range: 100-277Vac; otherwise: 100-240Vac.

(2) Measured at 100% load and 220 Vac input.

(3) Non-Class 2 output (USR & CNR).

(4) Class 2 output (USR), Non-Class 2 output (CNR).

(5) Class 2 output (USR & CNR).

(6) SELV.

(7) Meet with KC and KCC Certification.

Input Specifications

Parameter	Min.	Typ.	Max.	Notes
Input Voltage Range	90 V	-	305 V	

Input Specifications (Continued)

Parameter	Min.	Typ.	Max.	Notes
Input Frequency	47 Hz	-	63 Hz	
Leakage Current	-	-	0.75 MIU	UL8750; 277Vac/ 60Hz
	-	-	0.70 mA	IEC60598-1; 240Vac/ 60Hz
Input AC Current	-	-	0.4 A	Measured at 100% load and 100 Vac input.
	-	-	0.2 A	Measured at 100% load and 220 Vac input.
Inrush Current(I ² t)	-	-	0.043 A ² s	At 220Vac input 25°C Cold Start. Duration=100 μs, 10%I _{pk} -10%I _{pk} . See Inrush Current Waveform for the details.
Power Factor	0.90	-	-	At100-277Vac,50-60Hz,75%-100%load (19.5~26W)
THD	-	-	20%	

Output Specifications

Parameter	Min.	Typ.	Max.	Notes
Output Current Tolerance	-5%I _o	-	5%I _o	
Total Output Current Ripple (pk-pk)	-	-	50%I _o	Related to V-I Curve of the LED
No Load Output Voltage				
I _o = 350 mA	-	-	85 V	
I _o = 450 mA	-	-	59 V	
I _o = 530 mA	-	-	56 V	
I _o = 700 mA	-	-	42 V	
I _o = 1050 mA	-	-	32 V	
I _o = 1400 mA	-	-	26 V	
I _o = 1750 mA	-	-	22 V	
Output Current Overshoot / Undershoot	-	-	10%I _o	At 100% load condition
Line Regulation	-	-	±1%	Measured at 100% load condition
Load Regulation	-	-	±3%	
Turn-on Delay Time	-	0.40 s	0.75 s	Measured at 120Vac input, 75%~100%load
	-	0.30 s	0.50 s	Measured at 220Vac input, 75%~100%load
Temperature Coefficient of I _{omax}	-	-	0.2%/°C	Case temperature = 0°C~T _c max.
12V Auxiliary Output Voltage	10.8 V	12 V	13.2 V	
12V Auxiliary Output Source Current	0 mA	-	20 mA	Return terminal is "Dim-".

General Specifications

Parameter	Min.	Typ.	Max.	Notes
Efficiency at 120 Vac input: I _o = 350 mA I _o = 450 mA I _o = 530 mA I _o = 700 mA I _o = 1050 mA I _o = 1400 mA I _o = 1750 mA	84% 82% 82% 82% 81% 80% 80%	85% 84% 84% 84% 83% 81% 81%	- - - - - - -	Measured at 100% load and steady-state temperature in 25°C ambient.
Efficiency at 220 Vac input: I _o = 350 mA I _o = 450 mA I _o = 530 mA I _o = 700 mA I _o = 1050 mA I _o = 1400 mA I _o = 1750 mA	85% 83% 83% 83% 82% 80% 80%	86% 85% 85% 85% 84% 82% 81%	- - - - - - -	Measured at 100% load and steady-state temperature in 25°C ambient.
Efficiency at 277 Vac input: I _o = 350 mA I _o = 450 mA I _o = 530 mA I _o = 700 mA I _o = 1050 mA I _o = 1400 mA I _o = 1750 mA	84% 82% 82% 82% 81% 80% 80%	85% 84% 84% 84% 83% 81% 81%	- - - - - - -	Measured at 100% load and steady-state temperature in 25°C ambient.
No Load Power Dissipation	-	-	5 W	
MTBF	200,000 Hours	-	-	Measured at 120Vac input, 80%Load and 25°C ambient temperature (MIL-HDBK-217F)
Lifetime	-	91,100 Hours	-	Measured at 120Vac input, 80%Load and 60°C Case temperature. See life time vs. T _c curve for the details
Operating Case Temperature for Safety T _{c_s}	-40 °C	-	+90 °C	
Operating Case Temperature for Warranty T _{c_w}	-40 °C	-	+70 °C	Humidity: 10% RH to 95% RH.
Operating Case Temperature for Type TL T _{c_TL}	-40 °C	-	+72 °C	
Storage Temperature	-40 °C	-	+85 °C	Humidity: 5% RH to 95% RH
Dimensions Inches (L × W × H) Millimeters (L × W × H)	3.09 × 3.15 × 1.06 78.4 × 80 × 27			
Net Weight	-	230 g	-	

Dimming Specifications

Parameter	Min.	Typ.	Max.	Notes
Absolute Maximum Voltage on the 0~10V Input Pin	0 V	-	15 V	
Source Current on 0~10V Input Pin	0 uA	200 uA	250 uA	
Dimming Output Range	10%I _{omax}	-	100%I _{omax}	

Dimming Specifications (Continued)

Parameter	Min.	Typ.	Max.	Notes
Recommended Dimming Input Range	0 V	-	10 V	

Safety & EMC Compliance

Safety Category	Standard
UL/CUL	UL8750, UL 1310, CAN/CSA-C22.2 No. 250.13, CAN/CSA-C22.2 No. 223-M91
ENEC & TUV & CE	EN 61347-1, EN 61347-2-13
CB	IEC 61347-1, IEC 61347-2-13
PSE	J 61347-1, J 61347-2-13
KC	K 61347-1, K 61347-2-13
KS	KS C 7655
EMI Standards	Notes
EN 55015/KN 15 ⁽¹⁾	Conducted emission Test & Radiated emission Test
EN 61000-3-2	Harmonic current emissions
EN 61000-3-3	Voltage Fluctuations & Flicker
FCC Part 15 ⁽¹⁾	ANSI C63.4 Class B This device complies with Part 15 of the FCC Rules. Operation is subject to the following two conditions: [1] this device may not cause harmful interference, and [2] this device must accept any interference received, including interference that may cause undesired operation.
EMS Standards	Notes
EN 61000-4-2	Electrostatic Discharge (ESD): 8 kV air discharge, 4 kV contact discharge
EN 61000-4-3	Radio-Frequency Electromagnetic Field Susceptibility Test-RS
EN 61000-4-4	Electrical Fast Transient / Burst-EFT
EN 61000-4-5	Surge Immunity Test: AC Power Line: Differential Mode 2 kV
EN 61000-4-6	Conducted Radio Frequency Disturbances Test-CS
EN 61000-4-8	Power Frequency Magnetic Field Test
EN 61000-4-11	Voltage Dips
EN 61547	Electromagnetic Immunity Requirements Applies To Lighting Equipment

Note: (1) This LED driver meets the EMI specifications above, but EMI performance of a luminaire that contains it depends also on the other devices connected to the driver and on the fixture itself.

Lifetime vs. Case Temperature

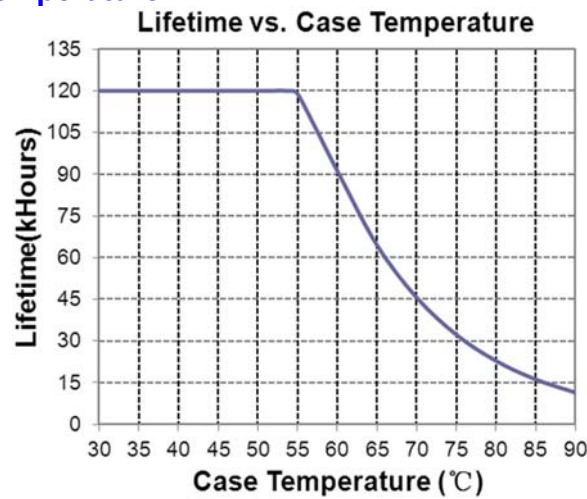

Inrush Current Waveform

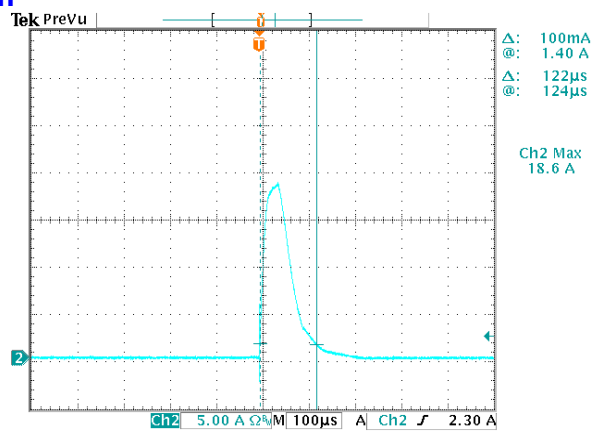

Efficiency vs. Load

EUC-026S035DS(PS)

Efficiency vs. Output Voltage

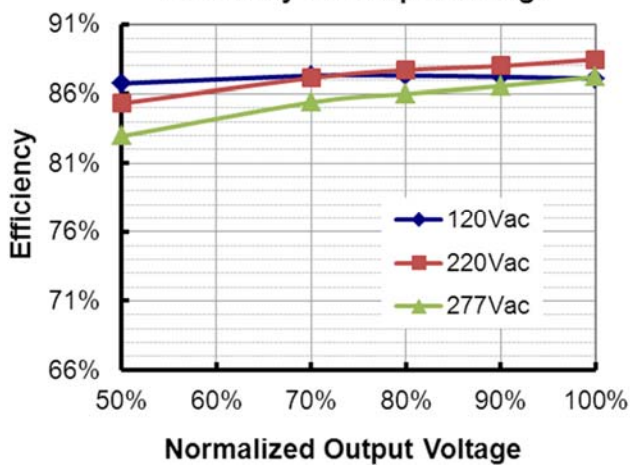

EUC-026S045DS(PS)

Efficiency vs. Output Voltage

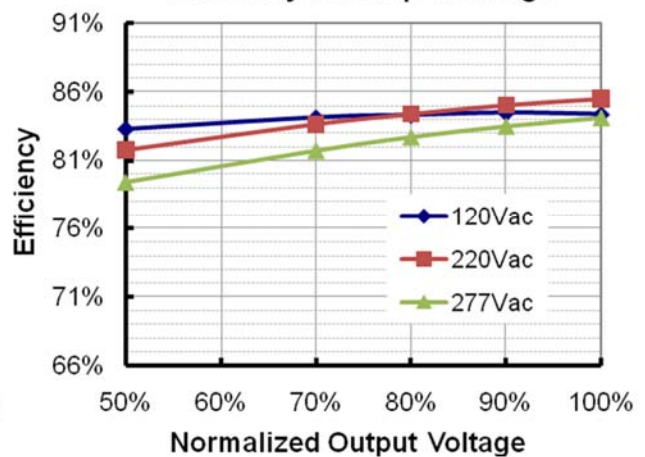

EUC-026S053DS(PS)

Efficiency vs. Output Voltage

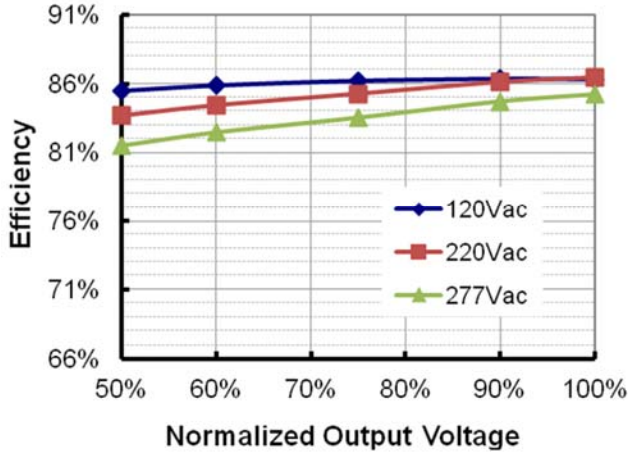

EUC-026S070DS(PS)

Efficiency vs. Output Voltage

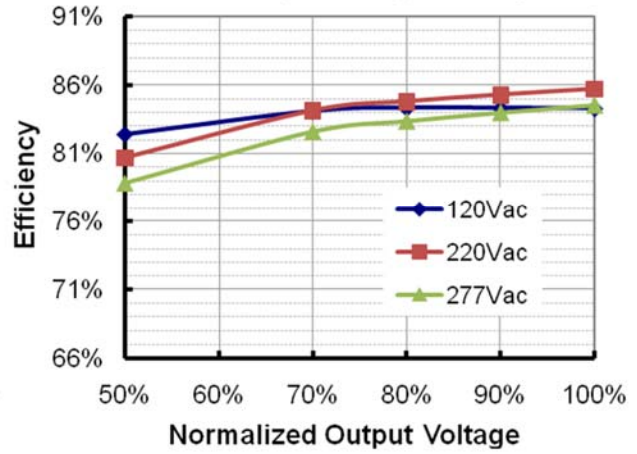

EUC-026S105DS(PS)

Efficiency vs. Output Voltage

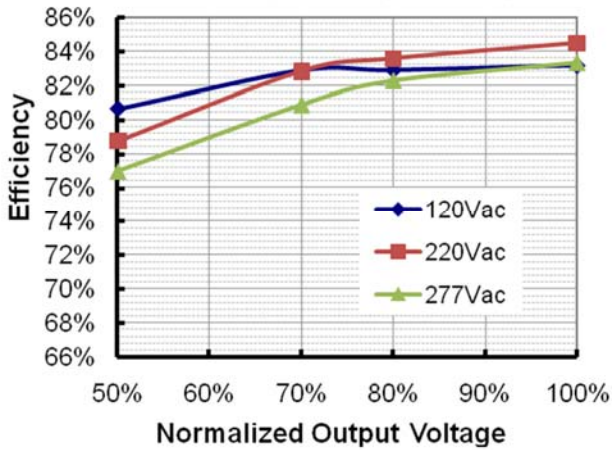

EUC-026S140DS(PS)

Efficiency vs. Output Voltage

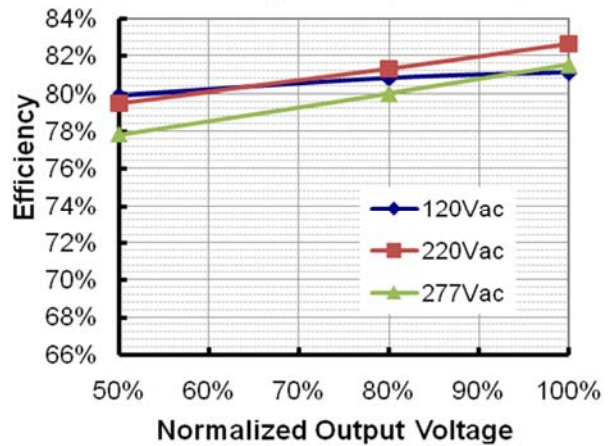

EUC-026S175DS(PS)

Efficiency vs. Output Voltage

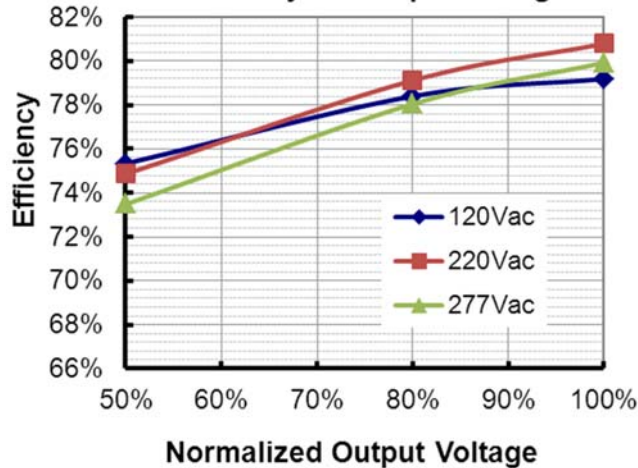

Power Factor

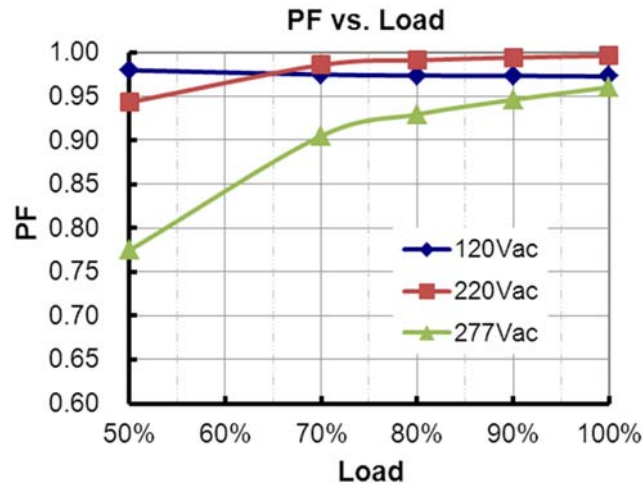

Total Harmonic Distortion

EUC-026S053DS(PS)

THD vs. Load

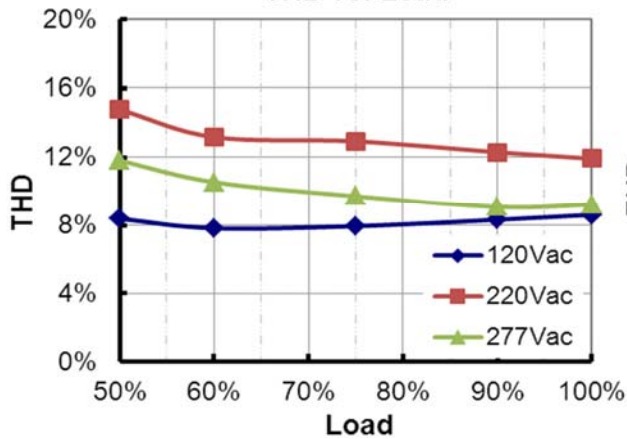

OTHER

THD vs. Load

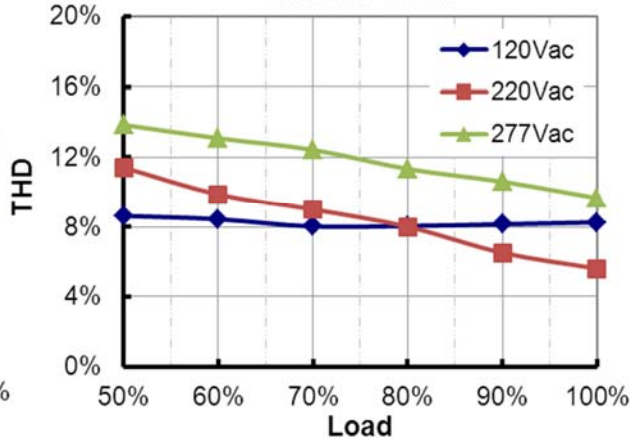

Protection Functions

Parameter	Notes
Over Voltage Protection	Limits output voltage at no load and in case the normal voltage limit fails.
Short Circuit Protection	Auto Recovery. No damage shall occur when any output operating in a short circuit condition. The power supply shall be self-recovery when the fault condition is removed.

Dimming

● 0-10V Dimming

The dimmer control may be operated from either a dimmer or from an input signal of 0 - 10 Vdc. The recommended implementation is provided below.

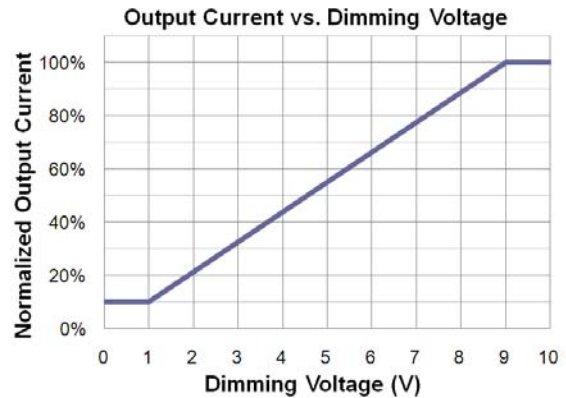
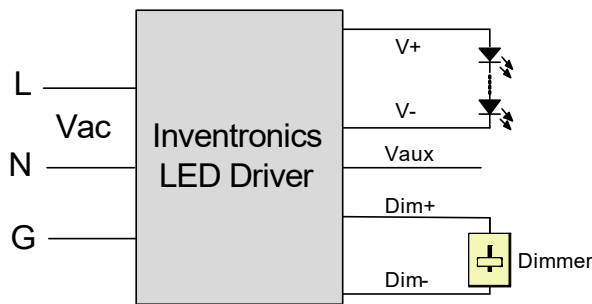

Implementation 1: DC Input

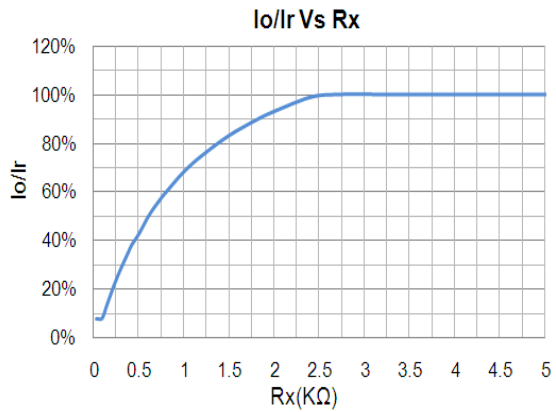
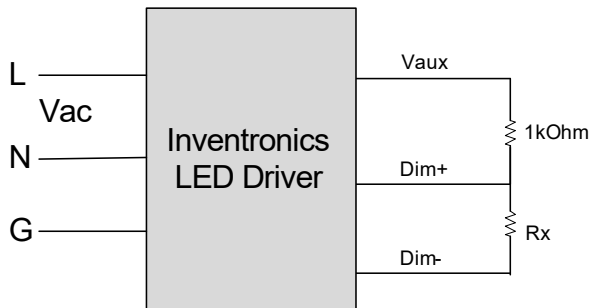

Implementation 2: External Resistor

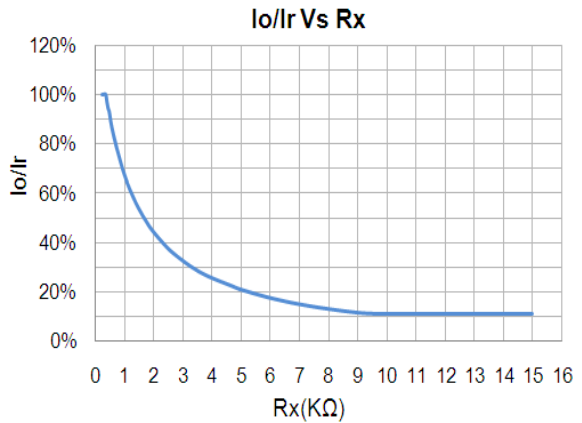
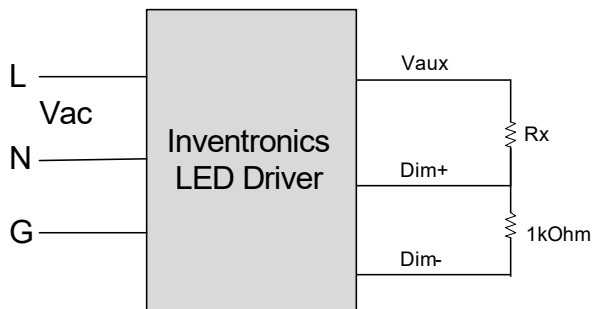

Implementation 3: External Resistor

Notes:

1. Do not connect the Dim- to the V-, otherwise, the LED driver cannot work normally.
2. If 0-10V dimming is not used, Dim + can be either open or connected to Vaux.

Mechanical Outline

EUC-026SxxxDS

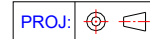
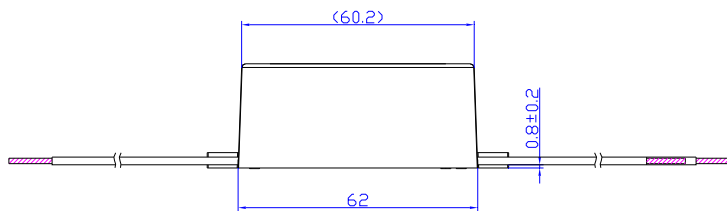
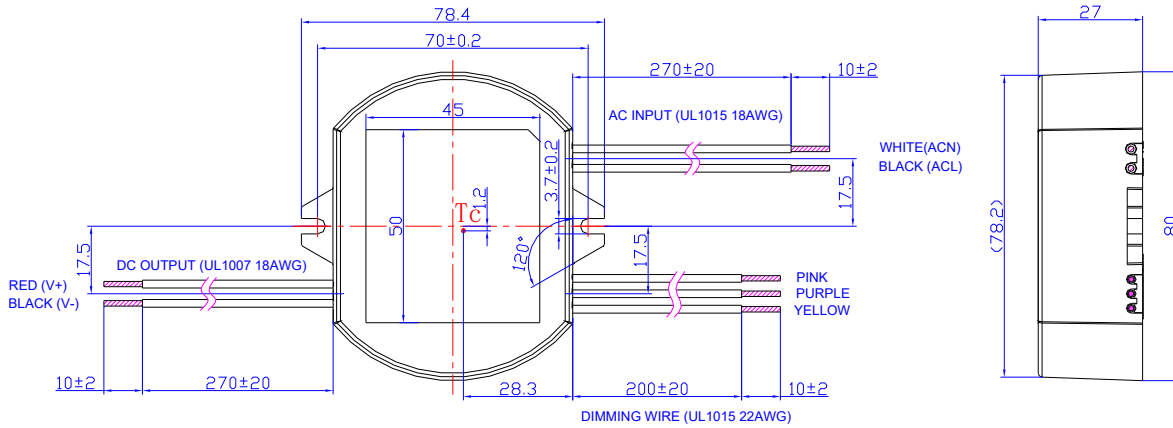

Unspecified tolerance: ±1

EUC-026SxxxPS

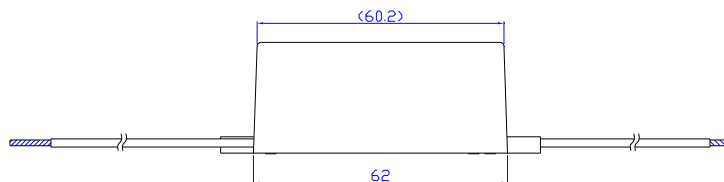
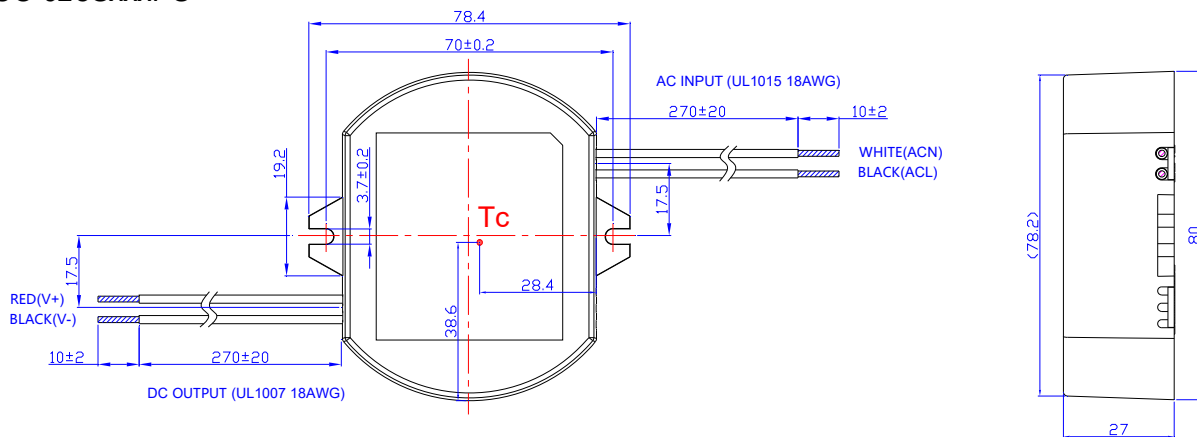

Unspecified tolerance: ±1

RoHS Compliance

Our products comply with reference to RoHS Directive (EU) 2015/863 amending 2011/65/EU, calling for the elimination of lead and other hazardous substances from electronic products.

Revision History

Change Date	Rev.	Description of Change		
		Item	From	To
2012-2-17	A	Datasheets Release	/	/
2012-05-25	B	EN 61000-4-5--- line to line 2 kV, line to earth 4 kV	/	Corrected
		Life time	/	50,000 Hours
		EUC-026S045DS(PS)-0001	/	Added
2012-06-06	C	Life time vs. Tc Curve	/	Added
		EUC-026S045DS(PS)-0001	/	Deleted
		Notes of life time	/	Updated
2012-7-17	D	Max Case Temperature	/	Updated
2012-7-30	E	Min Operating Temperature	-20°C	-40°C
2012-08-20	F	Derating Curve	/	Updated
		Life time Curve	/	Updated
		Inrush Current	60 A	40 A
		Inrush Current(I ² t)	/	Added
		Temperature co-efficient	/	Added
2012-11-09	G	Life time	Min 50,000hrs	Typical 91,100hrs
		Life time Curve	/	Updated
		THD Curve	/	Added
		Io/Ir Vs Rx Curve	/	Added
		Efficiency Curve and PF Curve of other models except 350 mA	/	Added
2013-11-26	H	Model 530mA	/	Added
2014-05-27	I	ENEC certificate	/	Added
2015-08-04	J	Warranty Tc	/	Added
		Environmental Specifications	/	Deleted
		Inrush Current Waveform	/	Added
		CCC certificate	/	Added
		CQC certificate	/	Deleted
		Source Current on 0~10V Input Pin Max.	200uA	250uA
		UL Type TL	/	Added

Revision History (Continued)

Change Date	Rev.	Description of Change		
		Item	From	To
2016-04-18	K	KC certificate - EUC-026S070/140/175DS(PS)	/	Added
		Net Weight	200 g	230 g
		KS Certificate Regulation	/	Added
		Note of EMI Standard	/	Added
2016-08-02	L	Turn-on Delay Time at 120Vac	Max.=1.0 s	Max.=0.75 s
2019-08-14	M	TUV Logo	/	Updated
		ENEC Logo	/	Updated
		CCC Logo	/	Deleted
		PSE Logo	/	Updated
		Input Specifications(PF/THD)	50-60Hz	Added
		Safety &EMC Compliance	UL/CUL	Updated
		Safety &EMC Compliance	ENEC	Added
		Safety &EMC Compliance	TUV	Added
		Safety &EMC Compliance	CB	Added
		Safety &EMC Compliance	CCC	Deleted
		Safety &EMC Compliance	PSE	Added
		Safety &EMC Compliance	KS	Updated
		Safety &EMC Compliance	KC	Added
		Safety &EMC Compliance	KCC	Added
		Safety &EMC Compliance	FCC	Updated
		Safety &EMC Compliance	EN 61000-4-5	Updated
		RoHS Compliance	/	Updated
2022-02-18	N	Product Photograph	/	Updated
		Features	/	Updated
		General Specification	/	Updated
		Mechanical Outline	/	Updated