

Features

- High Efficiency (Up to 89%)
- Second Generation with Improved Performance
- Active Power Factor Correction (Typical 0.95)
- Constant Current Output
- 0-10V Dimmable
- Input Surge Protection: DM 4kV, CM 6kV
- All-Around Protection: OVP, SCP, OLP, OTP
- IP67
- SELV Output
- 5 Years Warranty



Description

The EUC-036SxxxDV(SV) series is a 36W, constant-current IP67 LED driver that operates from 90~305 Vac input with excellent power factor. It is created for architecture lighting, decorative lighting, tunnel and street lighting. The high efficiency of these drivers and metal case enable them to run cooler, significantly improving reliability and extending product life. To ensure trouble-free operation, protection is provided against input surge, output over voltage, short circuit, over load and over temperature.

Models

Output Current	Input Voltage Range(1)	Output Voltage Range	Max. Output Power	Typical Efficiency (2)	Typical Power Factor		Model Number (3)
					120Vac	220Vac	
350 mA	90 ~ 305 Vac	52~103 Vdc	36 W	89%	0.96	0.95	EUC-036S035DV(SV)
450 mA	90 ~ 305 Vac	40~80 Vdc	36 W	88%	0.96	0.95	EUC-036S045DV(SV)
700 mA	90 ~ 305 Vac	26~52 Vdc	36 W	88%	0.96	0.95	EUC-036S070DV(SV)
1050 mA	90 ~ 305 Vac	18~35 Vdc	36 W	87%	0.96	0.95	EUC-036S105DV(SV)
1400 mA	90 ~ 305 Vac	13~26 Vdc	36 W	86%	0.96	0.95	EUC-036S140DV(SV)
1750 mA	90 ~ 305 Vac	11~21 Vdc	36 W	85%	0.96	0.95	EUC-036S175DV(SV)

- Notes:** (1) Certified input Voltage range 100-240Vac.
 (2) Measured at 100% load and 220 Vac input.
 (3) SELV output.

Input Specifications

Parameter	Min.	Typ.	Max.	Notes
Input Voltage	90 Vac	-	305 Vac	
Input Frequency	47 Hz	-	63 Hz	
Leakage Current	-	-	0.70 mA	IEC 60598-1; 240Vac/60Hz
Input AC Current	-	-	0.6 A	Measured at 100% load and 100 Vac input.

Specifications are subject to changes without notice.

1 / 11

All specifications are typical at 25 °C unless otherwise stated.

Input Specifications(Continued)

Parameter	Min.	Typ.	Max.	Notes
Input AC Current	-	-	0.3 A	Measured at 100% load and 220 Vac input.
Inrush Current(I ² t)	-	-	0.57 A ² s	At 220Vac input 25°C Cold Start. Duration=400 μs, 10%Ipk-10%Ipk. See Inrush Current Waveform for the details.
Power Factor	0.90	-	-	At 100Vac-277Vac, 75%load-100% load (27~36W)
THD	-	-	20%	

Output Specifications

Parameter	Min.	Typ.	Max.	Notes
Output Current Tolerance	-5%I _o	-	5%I _o	
No load output voltage I _o = 350 mA I _o = 450 mA I _o = 700 mA I _o = 1050 mA I _o = 1400 mA I _o = 1750 mA	- - - - - -	- - - - - -	114 V 87 V 58 V 39 V 31 V 26 V	
Total Output Current Ripple (pk-pk)	-	-	50%I _o	Related to V-I Curve of the LED
Output Current Overshoot / Undershoot	-	-	10%I _o	At 100% load condition.
Line Regulation	-	-	±1%	Measured at 100% load condition.
Load Regulation	-	-	±3%	
Turn-on Delay Time	-	0.6 s	1.0 s	Measured at 120Vac input, 75%load-100%load
	-	0.3 s	0.5 s	Measured at 220Vac input, 75%load-100%load
Temperature coefficient	-	0.2%/°C	-	Case temperature = 0°C ~T _c max.
12V Output Voltage	10.8 V	12 V	13.2 V	
12V Output Source Current	0 mA	-	20 mA	Return terminal is "Dim-".

General Specifications

Parameter	Min.	Typ.	Max.	Notes
Efficiency at 120 Vac input: I _o = 350 mA I _o = 450 mA I _o = 700 mA I _o = 1050 mA I _o = 1400 mA I _o = 1750 mA	87% 86% 86% 85% 85% 84%	89% 88% 87% 86% 86% 85%	- - - - - -	Measured at 100% load and steady-state temperature in 25°C ambient.

General Specifications (Continued)

Parameter	Min.	Typ.	Max.	Notes
Efficiency at 220 Vac input: I _o = 350 mA I _o = 450 mA I _o = 700 mA I _o = 1050 mA I _o = 1400 mA I _o = 1750 mA	87% 86% 86% 85% 85% 84%	89% 88% 88% 87% 86% 85%	- - - - - -	Measured at 100% load and steady-state temperature in 25°C ambient.
Efficiency at 277 Vac input: I _o = 350 mA I _o = 450 mA I _o = 700 mA I _o = 1050 mA I _o = 1400 mA I _o = 1750 mA	86% 86% 86% 85% 85% 84%	88% 88% 88% 87% 86% 85%	- - - - - -	Measured at 100% load and steady-state temperature in 25°C ambient.
No Load Power Dissipation	-	-	6 W	
MTBF	371,000 Hours	-	-	Measured at 120Vac input, 80%Load and 25°C ambient temperature (MIL-HDBK-217F)
Lifetime	-	111,700 Hours	-	Measured at 120Vac input, 80%Load and 60°C case temperature, See life time vs. T _c curve for the details
Operating Case Temperature for Safety T _{c_s}	-40 °C	-	+90 °C	
Operating Case Temperature for Warranty T _{c_w}	-40 °C	-	+70 °C	Case temperature for 5 years warranty. Humidity: 10% RH to 100% RH
Storage Temperature	-40 °C	-	+85 °C	Humidity: 5% RH to 100% RH
Dimensions Inches (L × W × H) Millimeters (L × W × H)	6.77 × 1.77 × 1.38 172 × 45.0 × 35.0			With mounting ear 7.60 × 1.77 × 1.38 193 × 45.0 × 35.0
Net Weight	-	520 g	-	

Dimming Specifications

Parameter	Min.	Typ.	Max.	Notes
Absolute Maximum Voltage on the 0~10V Input Pin	0 V	-	15 V	
Source Current on 0~10V Input Pin	0 μA	200 μA	250 μA	
Dimming Output Range	10%I _{omax}		100%I _{omax}	
Recommended Dimming Input Range	0 V	-	10 V	

Safety & EMC Compliance

Safety Category	Standard
TUV & CE	EN 61347-1, EN61347-2-13
CB	IEC 61347-1, IEC 61347-2-13
CCC	GB 19510.1, GB 19510.14
PSE	J 61347-1, J 61347-2-13
KS	KS C 7655
EMI Standards	Notes
EN IEC 55015/GB/T 17743 ⁽¹⁾	Conducted emission Test & Radiated emission Test
EN IEC 61000-3-2/GB 17625.1	Harmonic Current Emissions
EN 61000-3-3	Voltage Fluctuations & Flicker
EMS Standards	Notes
EN 61000-4-2	Electrostatic Discharge (ESD): 8 kV air discharge, 4 kV contact discharge
EN 61000-4-3	Radio-Frequency Electromagnetic Field Susceptibility Test-RS
EN 61000-4-4	Electrical Fast Transient / Burst-EFT
EN 61000-4-5	Surge Immunity Test: AC Power Line: Differential Mode 4 kV, Common Mode 6 kV
EN 61000-4-6	Conducted Radio Frequency Disturbances Test-CS
EN 61000-4-8	Power Frequency Magnetic Field Test
EN 61000-4-11	Voltage Dips
EN 61547	Electromagnetic Immunity Requirements Applies To Lighting Equipment

Note: (1) This LED driver meets the EMI specifications above, but EMI performance of a luminaire that contains it depends also on the other devices connected to the driver and on the fixture itself.

Lifetime vs. Case Temperature

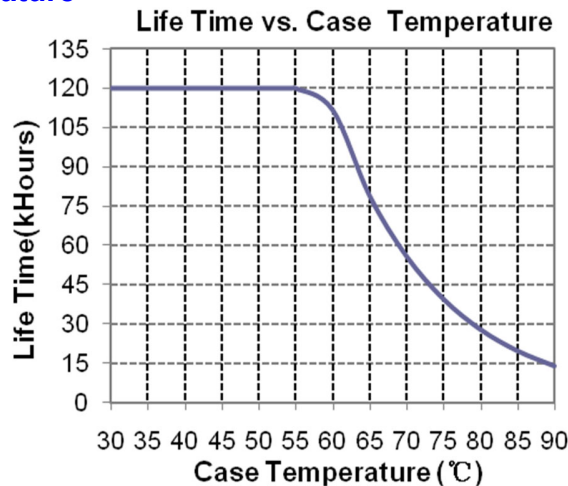

Inrush Current Waveform

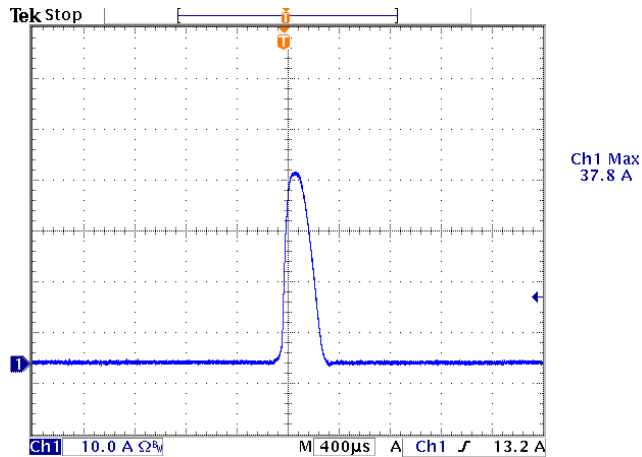

Efficiency vs. Load

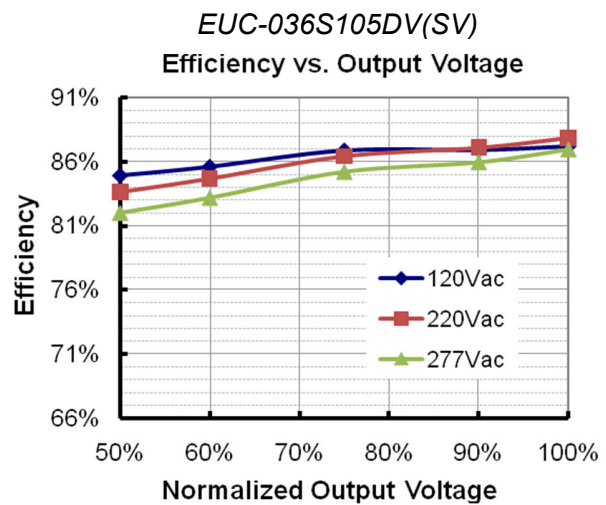
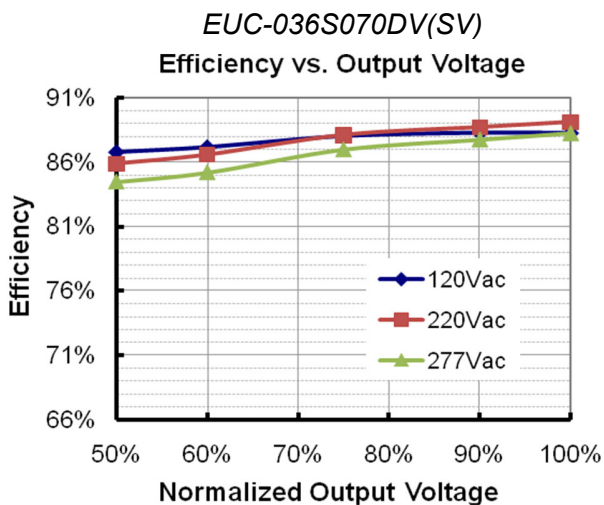
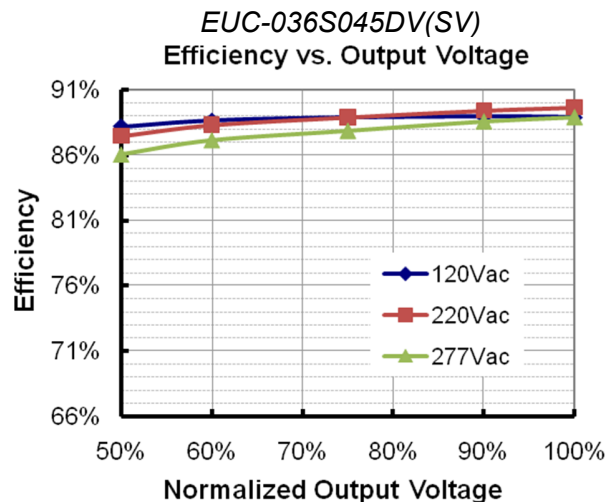
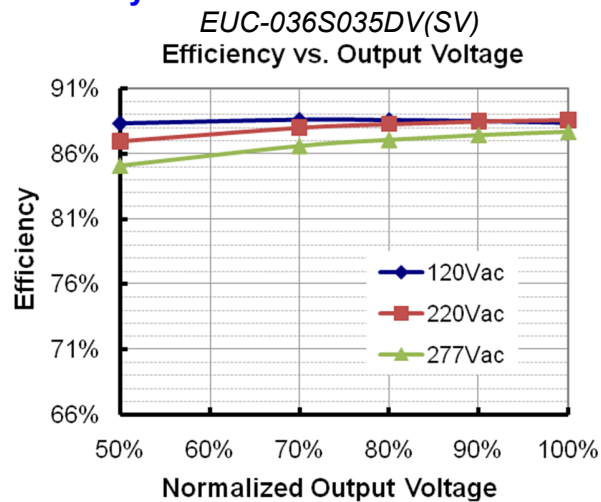

EUC-036S140DV(SV)

Efficiency vs. Output Voltage

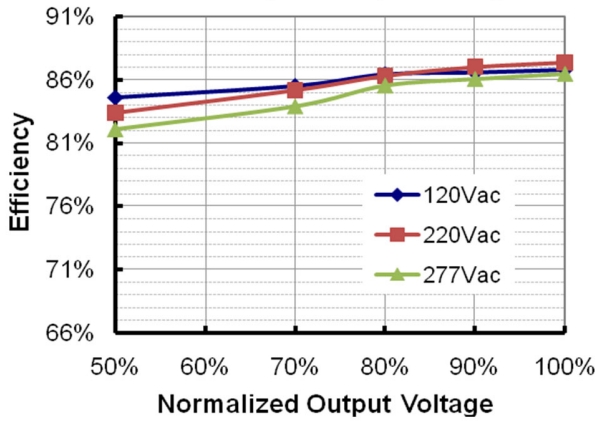

EUC-036S175DV(SV)

Efficiency vs. Output Voltage

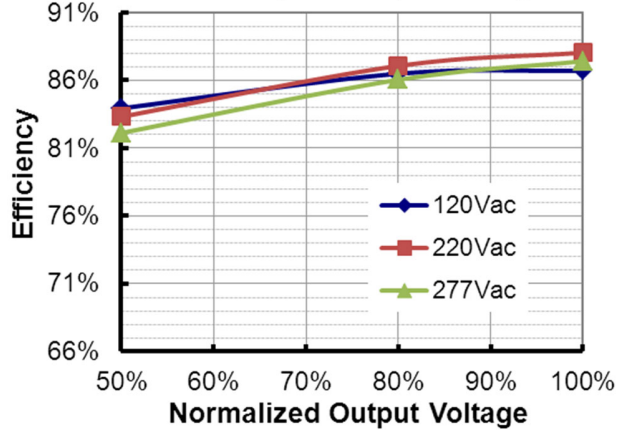

Power Factor

PF vs. Load

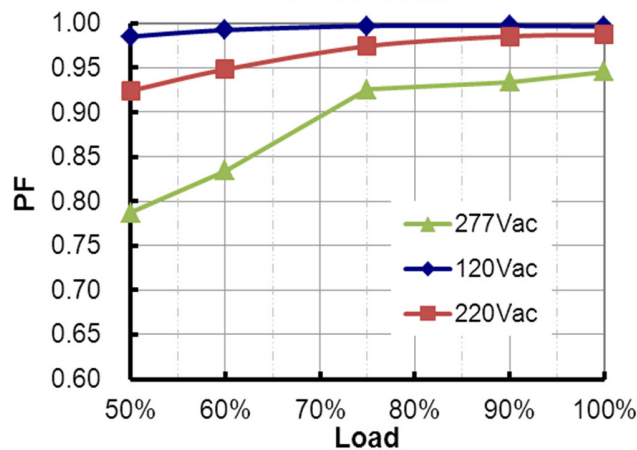

Total Harmonic Distortion

THD vs. Load

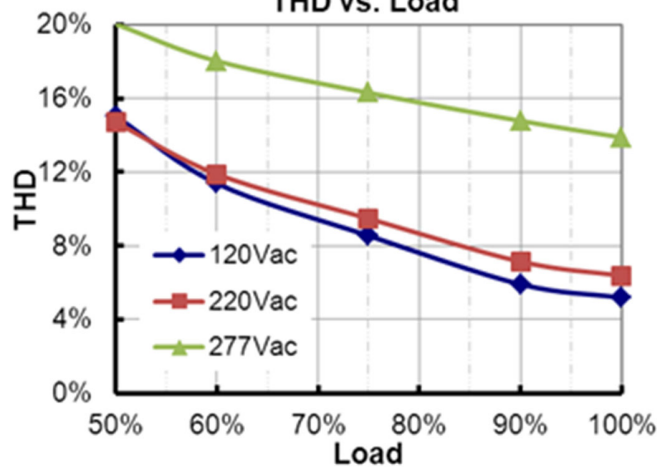

Protection Functions

Parameter	Notes
Over Voltage Protection	Limits output voltage at no load and in case the normal voltage limit fails.
Short Circuit Protection	Auto Recovery. No damage shall occur when any output operating in a short circuit condition. The power supply shall be self-recovery when the fault condition is removed.
Over Temperature Protection	Auto Recovery. Returning to normal after over temperature is removed.

Dimming

● 0-10V Dimming

The dimmer control may be operated from either a dimmer or from an input signal of 0 - 10 Vdc. The recommended implementation is provided below.

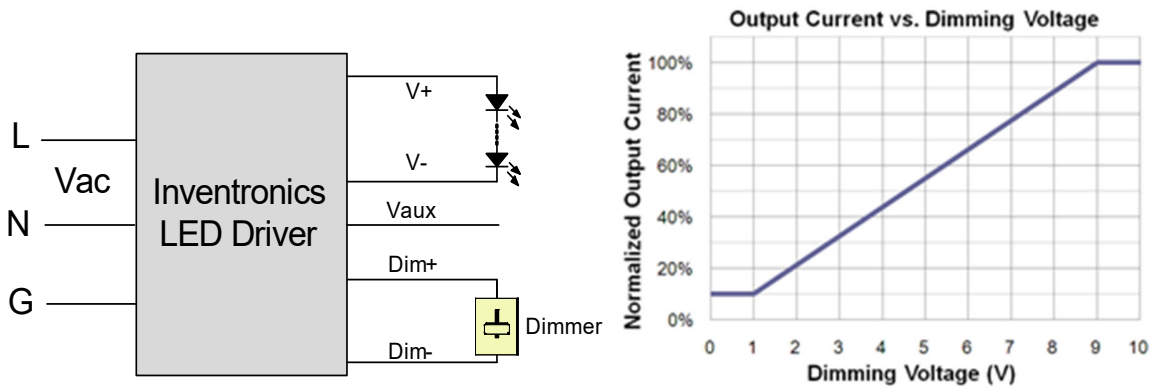

Implementation 1: DC Input

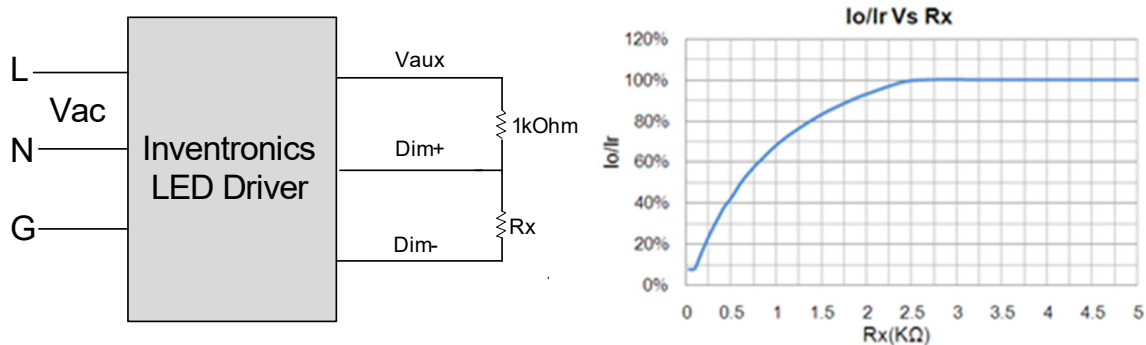

Implementation 2: External Resistor

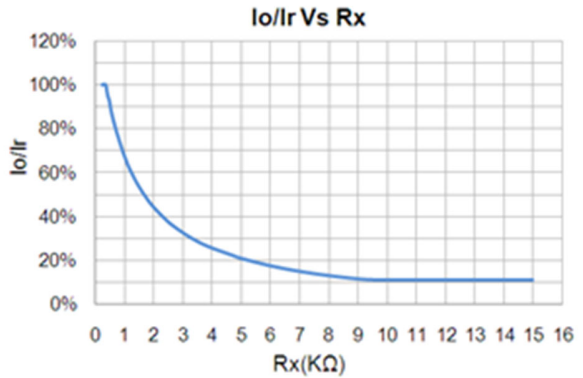
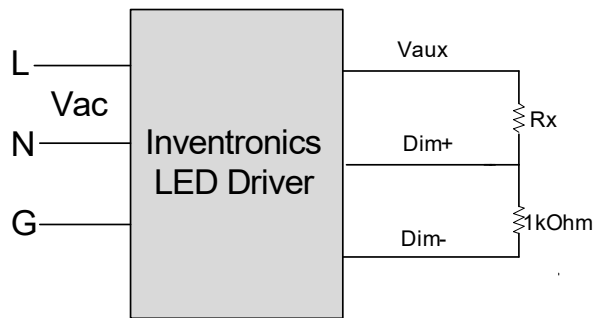

Implementation 3: External Resistor

Notes:

1. Do not connect the GND of dimming to the output, otherwise, the LED driver cannot work normally.
2. If 0-10V dimming is not used, Dim + can be either open or connected to Vaux.

Mechanical Outline

EUC-036SxxxDV

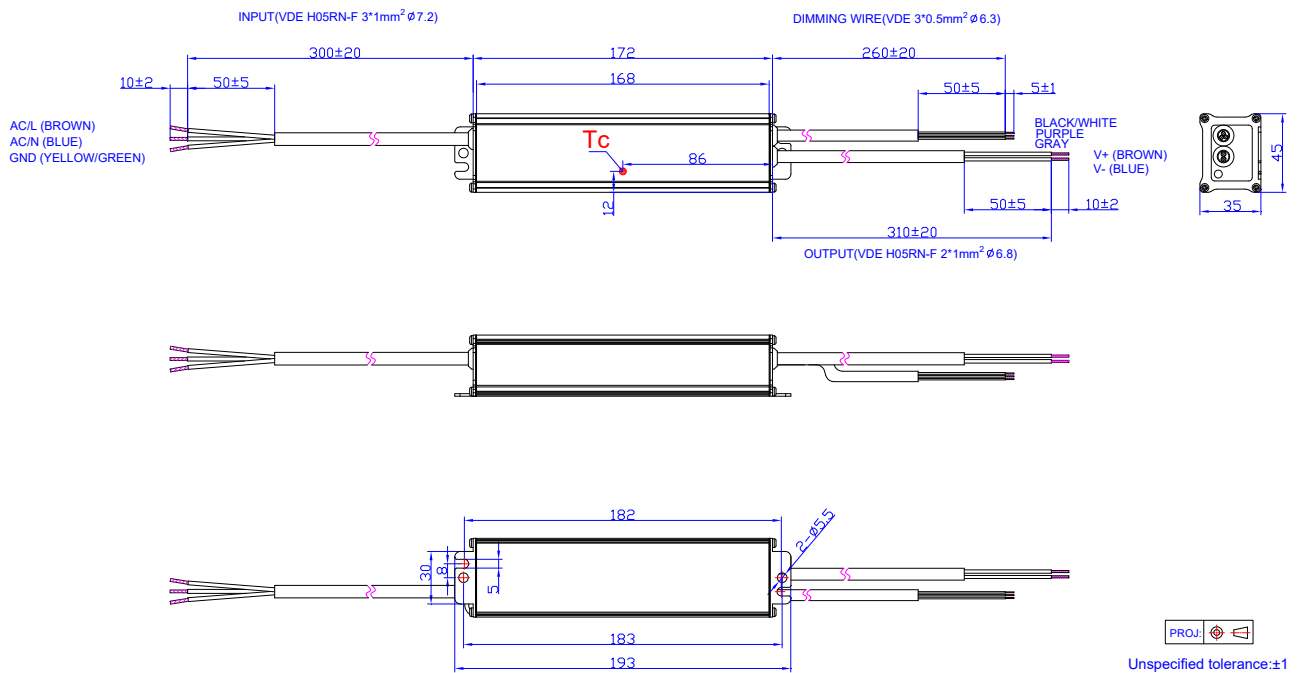

EUC-036SxxxSV

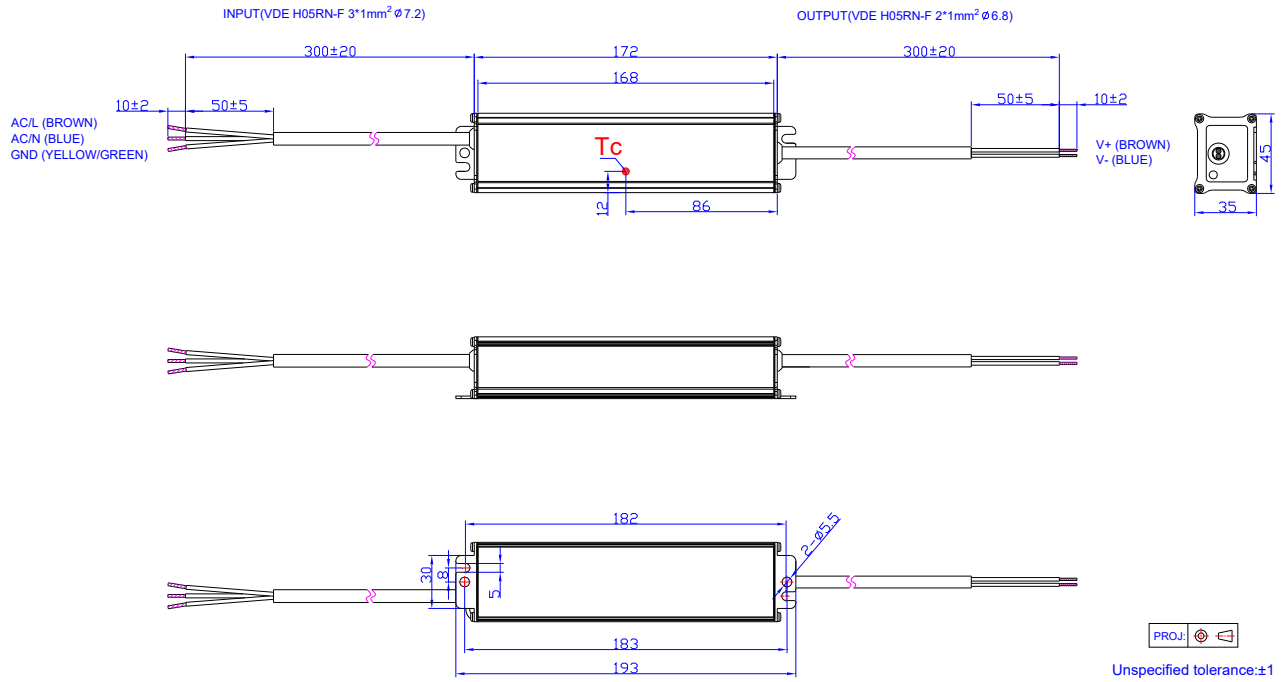

RoHS Compliance

Our products comply with reference to RoHS Directive (EU) 2015/863 amending 2011/65/EU, calling for the elimination of lead and other hazardous substances from electronic products.

Revision History

Change Date	Rev.	Description of Change		
		Item	From	To
2012-5-4	A	Datasheets Release	/	/
2012-05-25	B	EN 61000-4-5--- line to line 4 kV, line to earth 6 kV	/	Corrected
		Life time	/	50,000 Hours
2012-06-06	C	Life time vs. Tc Curve	/	Added
		Notes of life time	/	Updated
2012-07-02	D	Description of OTP	/	Updated
2012-7-17	E	Max Case Temperature	/	Updated
		Mechanical Outline— wire length 320±20mm	/	Corrected
2012-7-30	F	Min Operating Temperature	-35°C	-40°C
2012-8-16	G	Derating Curve	/	Updated
		Inrush Current(I ² t)	/	Added
		Temperature co-efficient	/	Added
2012-11-21	H	Life time	Min 50,000hrs	Typical 111,700hrs
		Life time Curve	/	Updated
		Mechanical Outline	/	Updated
		THD Curve	/	Added
		Io/Ir Vs Rx Curve	/	Added
		EFF and PF Curve of other models	/	Added
2015-07-21	I	Warranty Tc_w	/	Added
		Inrush Current(I ² t)	0.2 A ² s	0.57 A ² s
		Power Factor	/	Updated
		Total Harmonic Distortion	/	Updated
		Inrush Current Waveform	/	Added
		Dimming Control- Source Current on 0~10V Input Pin Max.	200 uA	250 uA
2015-12-25	J	KS Certification	/	Added
		Mechanical Outline-EUC-036SxxxDV-Dimming Wire	UL2464 3*22AWG	VDE 3*0.5mm ²
2016-04-18	K	Net Weight	480 g	520 g
		KS certificate Regulation	/	Added
		Note of EMI Standard	/	Added

Revision History (Continued)

Change Date	Rev.	Description of Change			
		Item	From	To	
2017-09-07	L	Features	/	Updated	
		Description	/	Updated	
		Dimming - 0-10V Dimming - Implementation	/	Corrected	
		Dimensions	Inches (L × W × H) Millimeters (L × W × H)	6.77 × 1.67 × 1.34 172 × 42.4 × 34.0	6.77 × 1.77 × 1.38 172 × 45.0 × 35.0
		Mechanical Outline	/	Updated	
2023-10-09	M	ENEC logo	/	Deleted	
		TUV/PSE logo	/	Updated	
		Product Photograph	/	Updated	
		Safety & EMC Compliance	/	Updated	