

Features

- High Efficiency (Up to 89%)
- Constant Current Output
- 0-10V Dimming Control
- Precise output current at minimum dimming
- All-Around Protection: OVP, SCP, OLP, OTP
- Waterproof (IP66) and UL Dry / Damp Location
- Class 2 & SELV Output
- Suitable for EU Built-in Use
- TYPE HL, for use in a Class I, Division 2 hazardous (Classified) location



Description

The EUC-042S070DSC series is a 42W, constant-current IP66 LED driver that operates from 90-305 Vac input with excellent power factor and precise current control at low dimming to avoid visible mismatch. It is created for down lights and panel lights. The high efficiency of these drivers enables them to run cooler, significantly improving reliability and extending product life. To ensure trouble-free operation, protection is provided against over voltage, short circuit, over load, and over temperature.

Models

Output Current	Input Voltage Range(1)	Output Voltage Range	Max. Output Power	Typical Efficiency (2)	Power Factor		Model Number
					120Vac	220Vac	
700 mA	90 ~ 305 Vac 127~ 300 Vdc	28~56 Vdc	39 W	89.0%	0.96	0.95	EUC-042S070DSC(3)(4)

- Notes:** (1) UL, FCC certified input voltage range: 100-277Vac or 127-300Vdc; other certified input voltage range except UL & FCC: 100-240Vac/127-250Vdc
 (2) Measured at full load and 220 Vac input.
 (3) Class 2 output for dry and damp location.
 (4) SELV output

Input Specifications

Parameter	Min.	Typ.	Max.	Notes
Input Voltage	90 Vac	-	305 Vac	127~300 Vdc
Input Frequency	47 Hz	-	63 Hz	
Leakage Current	-	-	0.75 MIU	UL8750; 277Vac/ 60Hz
	-	-	0.70 mA	IEC60598-1; 240Vac/ 60Hz
Input AC Current	-	-	0.6 A	Measured at full load and 100Vac input.
	-	-	0.3 A	Measured at full load and 220Vac input.

Input Specifications (Continued)

Parameter	Min.	Typ.	Max.	Notes
Inrush Current(I ² t)	-	-	0.07 A ² s	At 220Vac input 25°C cold start, duration= 92 μs, 10%Ipk-10%Ipk. See Inrush Current Waveform for the details.
PF	0.90	-	-	At 100-277Vac, 75%load-100%load (30-39W)
THD	-	-	20%	

Output Specifications

Parameter	Min.	Typ.	Max.	Notes
Output Current Tolerance	-5%I _o	-	5%I _o	At full load condition.
Total Output Current Ripple (pk-pk)	-	-	50%I _o	Related to V-I Curve of the LED
Startup Overshoot Current	-	-	10%I _o	At full load condition.
No load Output Voltage	-	-	59 V	
Line Regulation	-	-	±0.5%	Measured at full load
Load Regulation	-	-	±1.5%	
Turn-on Delay Time	-	-	0.75 s	Measured at 120Vac input, 75%load-100%load.
	-	-	0.50 s	Measured at 220Vac input, 75%load-100%load.
Temperature Coefficient of I _{omax}	-	-	0.03%/°C	Case temperature = 0°C ~T _c max
12V Auxiliary Output Voltage	10.8 V	12 V	13.2 V	
12V Auxiliary Output Source Current	0 mA	-	20 mA	Return terminal is "Dim"

Note: All specifications are typical at 25°C unless otherwise stated.

General Specifications

Parameter	Min.	Typ.	Max.	Notes
Efficiency at 120 Vac input:	86.5%	88.5%	-	Measured at full load and steady-state temperature in 25°C ambient; (Efficiency will be about 2.0% lower if measured immediately after startup.)
Efficiency at 220 Vac input:	87.0%	89.0%	-	Measured at full load and steady-state temperature in 25°C ambient; (Efficiency will be about 2.0% lower if measured immediately after startup.)
Efficiency at 277 Vac input:	86.0%	88.0%	-	Measured at full load and steady-state temperature in 25°C ambient; (Efficiency will be about 2.0% lower if measured immediately after startup.)

General Specifications (Continued)

Parameter	Min.	Typ.	Max.	Notes
MTBF	-	568,000 Hours	-	Measured at 120Vac input, 80%Load and 25°C ambient temperature (MIL-HDBK-217F)
Lifetime	-	116,000 Hours	-	Measured at 120Vac input, 80%Load and 60°C case temperature; See lifetime vs. Tc curve for the details
Operating Case Temperature for Safety Tc_s	-40 °C	-	+90 °C	
Operating Case Temperature for Warranty Tc_w	-40 °C	-	+70 °C	Humidity: 10% RH to 100% RH
Storage Temperature	-40 °C	-	+85 °C	Humidity: 5% RH to 100% RH
Dimensions Inches (L × W × H) Millimeters (L × W × H)	3.74 × 2.76 × 1.26 95 × 70 × 32			
Net Weight	-	390 g	-	

Note: All specifications are typical at 25°C unless otherwise stated.

Dimming Specifications

Parameter	Min.	Typ.	Max.	Notes
Absolute Maximum Voltage on the Vdim (+) Pin	-20 V	-	20 V	
Source Current on Vdim (+)Pin	0 uA	200 uA	250 uA	
Dimming Output Range	10%Iomax	-	100%Iomax	
Minimum Dimming Output Current	8.5%Iomax	10%Iomax	11.5%Iomax	
Recommended Dimming Input Range	0 V	-	10 V	

Safety & EMC Compliance

Safety Category	Standard
UL/CUL	UL8750, CAN/CSA-C22.2 No. 250.13-12
CE	EN 61347-1, EN61347-2-13
KS	KS C 7655: 2011
EMI Standards	Notes
EN 55015 ⁽¹⁾	Conducted emission Test & Radiated emission Test
EN 61000-3-2	Harmonic current emissions Class C
EN 61000-3-3	Voltage fluctuations & flicker

Safety & EMC Compliance (Continued)

EMI Standards	Notes
FCC Part 15 ⁽¹⁾	ANSI C63.4:2009 Class B
	This device complies with Part 15 of the FCC Rules. Operation is subject to the following two conditions: [1] this device may not cause harmful interference, and [2] this device must accept any interference received, including interference that may cause undesired operation.
EMS Standards	Notes
EN 61000-4-2	Electrostatic Discharge (ESD): 8 kV air discharge, 4 kV contact discharge
EN 61000-4-3	Radio-Frequency Electromagnetic Field Susceptibility Test-RS
EN 61000-4-4	Electrical Fast Transient / Burst-EFT: level 3, criteria A
EN 61000-4-5	Surge Immunity Test: AC Power Line: line to line 2 kV
EN 61000-4-6	Conducted Radio Frequency Disturbances Test-CS
EN 61000-4-8	Power Frequency Magnetic Field Test
EN 61000-4-11	Voltage Dips
EN 61547	Electromagnetic Immunity Requirements Applies To Lighting Equipment

Note: (1) This LED driver meets the EMI specifications above, but EMI performance of a luminaire that contains it depends also on the other devices connected to the driver and on the fixture itself.

Lifetime vs. Case Temperature

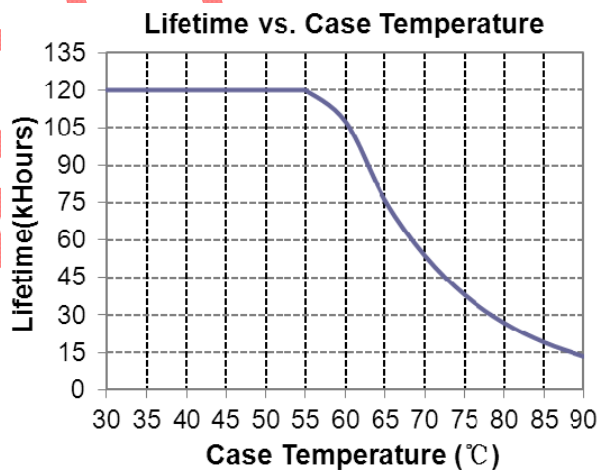

Inrush Current Waveform

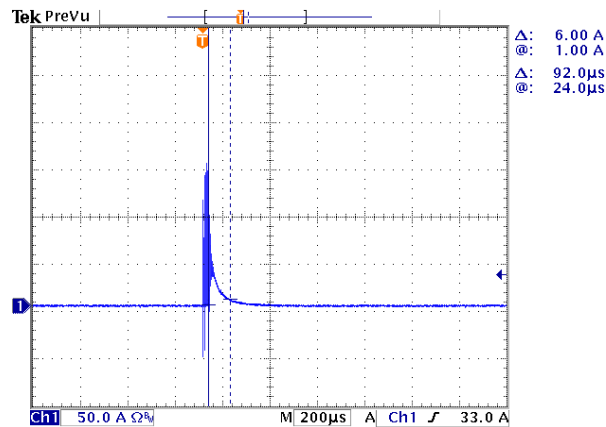

Efficiency vs. Load

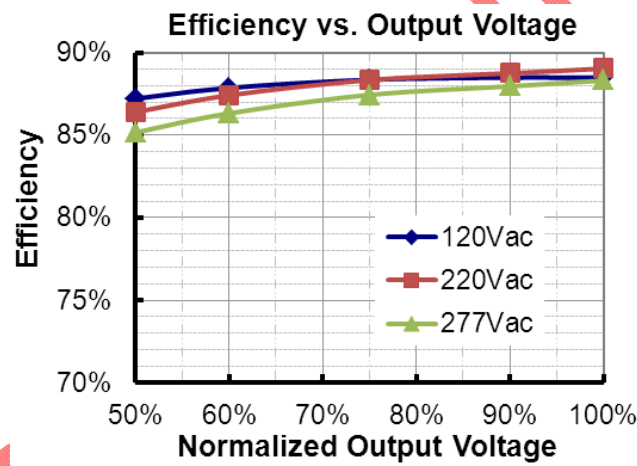

Power Factor

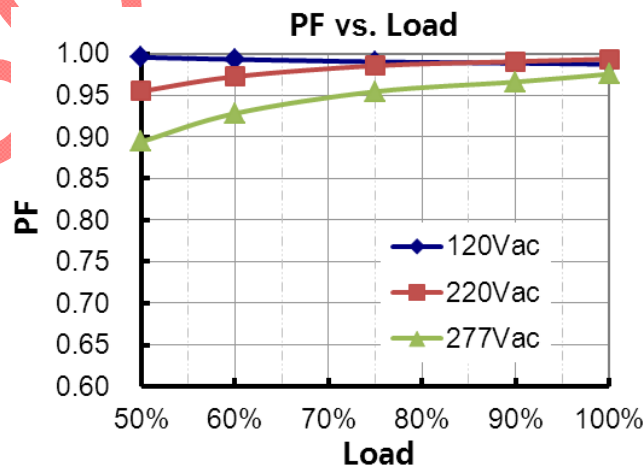

Total Harmonic Distortion

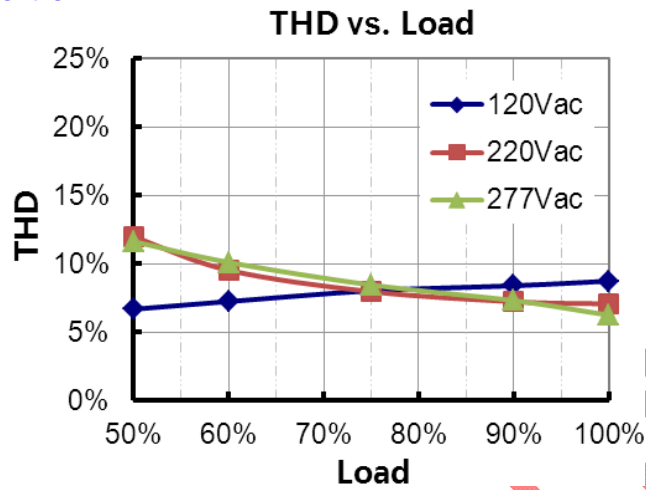

Protection Functions

Parameter	Notes
Over Temperature Protection	Hiccup mode. It will be back to normal condition after over temperature is removed.
Short Circuit Protection	Auto Recovery. No damage will occur when any output is short circuited. The output shall return to normal when the fault condition is removed.
Over Voltage Protection	Limits output voltage at no load and in case the normal voltage limit fails.

Dimming

● 0-10V Dimming

Recommended implementations of the dimming control are provided below.

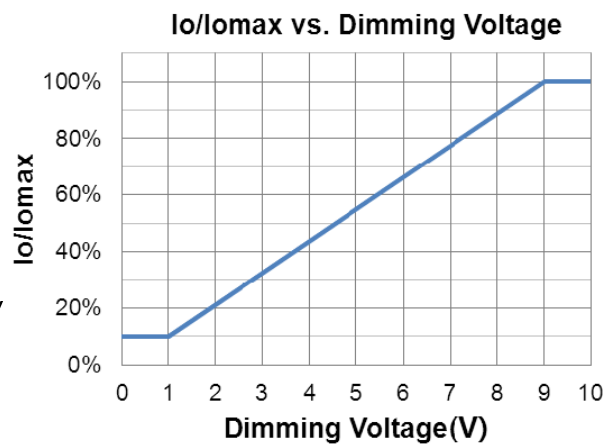
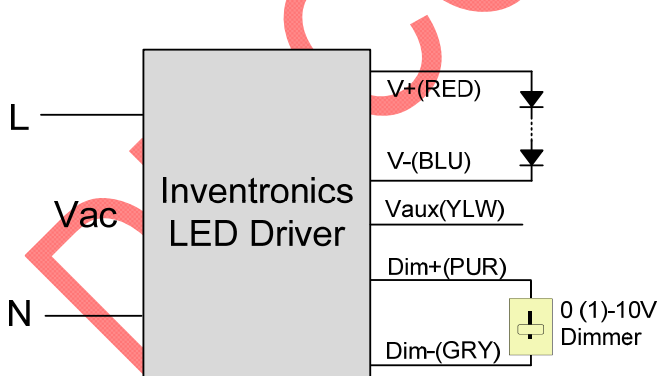

Implementation 1: DC Input

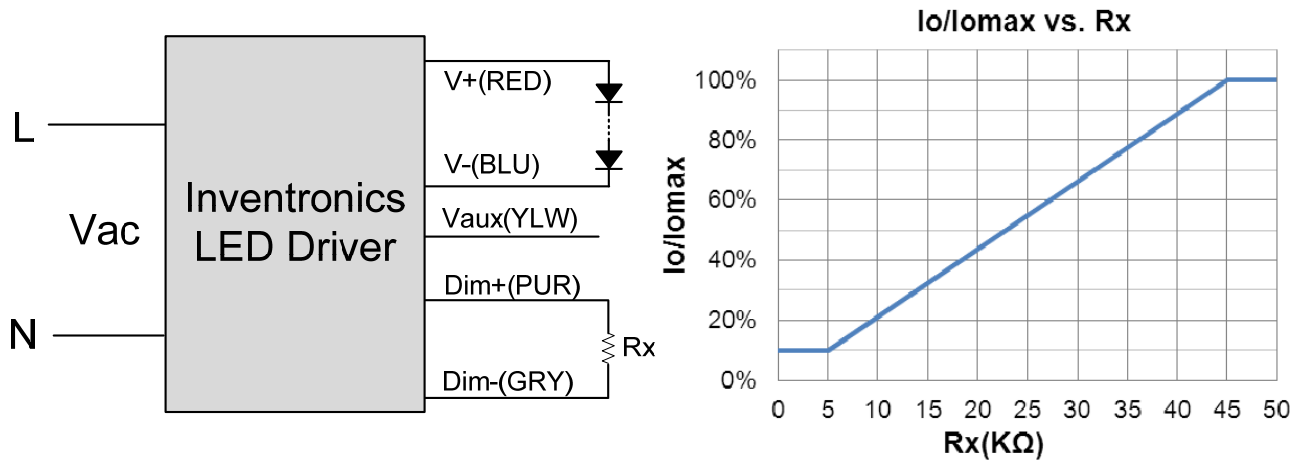

Implementation 2: External Resistor

Notes:

1. The dimmer can also be replaced by an active 0-10V voltage source signal or passive components like resistors and zener.
2. Do not connect Dim- to the output V- or V+, otherwise the driver will not work properly.
3. If 0-10V dimming is not used, Dim + can be either open or connected to Vaux.

Mechanical Outline

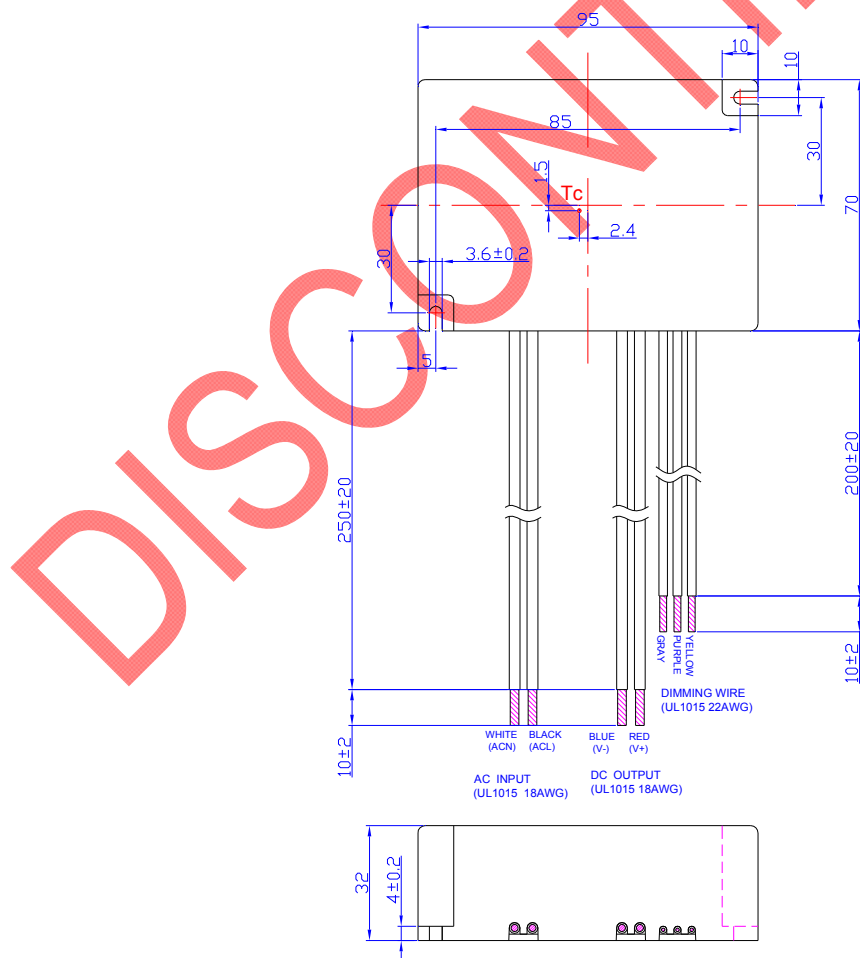

PROJ: [Symbol] [Symbol] [Symbol]
 Unspecified tolerance:±1

RoHS Compliance

Our products comply with the European Directive 2011/65/EC, calling for the elimination of lead and other hazardous substances from electronic products.

DISCONTINUED

Revision History

Change Date	Rev.	Description of Change		
		Item	From	To
2014-10-13	A	Datasheet Release	/	/
2016-04-18	B	Net Weight	500 g	390 g
		Source Current on Vdim (+) Pin Max.	200uA	250uA
		KS Certificate Regulation	/	Added
		Note of EMI Standard	/	Added
2016-08-02	C	Turn-on Delay Time at 120Vac	Max.=1.0 s	Max.=0.75 s

DISCONTINUED