

## Features

- Ultra High Efficiency (Up to 90%)
- Constant Current Output
- Surge Protection Level: DM 4kV, CM 6kV
- 0-10V Dimming Control
- Auxiliary High Source Current Capability(200 mA)
- Waterproof (IP66) and UL Dry / Damp Location
- All-Around Protection: OVP, SCP, OTP
- Class 2 & SELV Output
- Suitable for EU Built-in Use



## Description

The EUC-042SxxxDTM(STM) series is a 42W, constant-current IP66 LED driver in a metal case that operates from 90-305 Vac input with excellent power factor. It is created for many lighting applications including low bay, tunnel and signage, etc. The high efficiency of these drivers and compact metal case enable them to run cooler, significantly improving reliability and extending product life. To ensure trouble-free operation, protection is provided against over voltage, short circuit, and over temperature.

## Models

Output Current	Input Voltage Range(1)	Output Voltage Range	Max. Output Power	Typical Efficiency (2)	Power Factor		Model Number
					120Vac	220Vac	
350 mA	90 ~ 305 Vac 127~ 300 Vdc	60~120Vdc	42 W	90.0%	0.98	0.95	EUC-042S035DTM(STM) <sup>(3)</sup>
700 mA	90 ~ 305 Vac 127~ 300 Vdc	28~56 Vdc	39 W	89.5%	0.98	0.95	EUC-042S070DTM(STM) <sup>(4)(5)</sup>
1050 mA	90 ~ 305 Vac 127~ 300 Vdc	20~40 Vdc	42 W	88.0%	0.98	0.95	EUC-042S105DTM(STM) <sup>(4)(5)</sup>
1400 mA	90 ~ 305 Vac 127~ 300 Vdc	15~30 Vdc	42 W	88.0%	0.98	0.95	EUC-042S140DTM(STM) <sup>(4)(5)</sup>

**Notes:** (1) UL, FCC certified input voltage range: 100-277Vac/127-300Vdc; other certified input voltage range except UL & FCC: 100-240Vac/127-250Vdc(except KS).

(2) Measured at 100% load and 220 Vac input.

(3) Non-Class 2 output.

(4) Class 2 output for dry and damp location.

(5) SELV output.

## Input Specifications

Parameter	Min.	Typ.	Max.	Notes
Input Voltage	90 Vac	-	305 Vac	127~300 Vdc
Input Frequency	47 Hz	-	63 Hz	
Leakage Current	-	-	0.75 MIU	UL8750; 277Vac/ 60Hz
	-	-	0.70 mA	IEC60598-1; 240Vac/ 60Hz
Input AC Current	-	-	0.6 A	Measured at 100% load and 100Vac input.

## Input Specifications (Continued)

Parameter	Min.	Typ.	Max.	Notes
Input AC Current	-	-	0.3 A	Measured at 100% load and 220Vac input.
Inrush Current(I <sup>2</sup> t)	-	-	0.53 A <sup>2</sup> s	At 220Vac input 25°C cold start, duration= 264 μs, 10%Ipk-10%Ipk. See Inrush Current Waveform for the details.
PF	0.90	-	-	At 100Vac-277Vac, 50-60Hz,75% -100%load (32-42W)
THD	-	-	20%	

## Output Specifications

Parameter	Min.	Typ.	Max.	Notes
Output Current Tolerance	-5%Io	-	5%Io	At 100% load condition
Total Output Voltage Ripple (p-p)	-	5%Vo	10%Vo	At 100% load condition.
Startup Overshoot Current	-	-	10%Io	At 100% load condition.
No load Output Voltage Io = 350 mA Io = 700 mA Io = 1050 mA Io = 1400 mA	- - - -	- - - -	132 V 60 V 48 V 37 V	
Line Regulation	-	-	±0.5%	Measured at 100% load
Load Regulation	-	-	±1.5%	
Turn-on Delay Time	-	-	1.0 s	Measured at 120Vac input, 75%load-100%load
	-	-	0.6 s	Measured at 220Vac input, 75%load-100%load
Temperature Coefficient of Iomax	-	0.03%/°C	-	Case temperature = 0°C ~Tc max
12V Auxiliary Output Voltage	10.8 V	12 V	13.2 V	
12V Auxiliary Output Source Current	0 mA	-	200 mA	Return terminal is "Dim"

**Note:** All specifications are tested by Cree XLamp XP-G and typical at 25°C unless otherwise stated.

## General Specifications

Parameter	Min.	Typ.	Max.	Notes
Efficiency at 120 Vac input: Io = 350 mA Io = 700 mA Io = 1050 mA Io = 1400 mA	86.5% 86.5% 85.0% 85.0%	88.5% 88.5% 87.0% 87.0%	- - - -	Measured at 100% load and steady-state temperature in 25°C ambient; (Efficiency will be about 2.0% lower if measured immediately after startup.)
Efficiency at 220 Vac input: Io = 350 mA Io = 700 mA Io = 1050 mA Io = 1400 mA	88.0% 87.5% 86.0% 86.0%	90.0% 89.5% 88.0% 88.0%	- - - -	Measured at 100% load and steady-state temperature in 25°C ambient; (Efficiency will be about 2.0% lower if measured immediately after startup.)

## General Specifications (Continued)

Parameter	Min.	Typ.	Max.	Notes
Efficiency at 277 Vac input: I <sub>o</sub> = 350 mA I <sub>o</sub> = 700 mA I <sub>o</sub> = 1050 mA I <sub>o</sub> = 1400 mA	87.5% 87.0% 86.0% 86.0%	89.5% 89.0% 88.0% 88.0%	- - - -	Measured at 100% load and steady-state temperature in 25°C ambient; (Efficiency will be about 2.0% lower if measured immediately after startup.)
MTBF	-	573,000 Hours	-	Measured at 120Vac input, 80%Load and 25°C ambient temperature (MIL-HDBK-217F)
Lifetime	-	69,000 Hours	-	Measured at 120Vac input, 80%Load and 70°C case temperature; See lifetime vs. T <sub>c</sub> curve for the details
Operating Case Temperature for Safety T <sub>c_s</sub>	-40 °C	-	+89 °C	
Operating Case Temperature for Warranty T <sub>c_w</sub>	-40 °C	-	+75 °C	Humidity: 10% RH to 100% RH
Storage Temperature	-40 °C	-	+85 °C	Humidity: 5% RH to 100% RH
Dimensions Inches (L × W × H) Millimeters (L × W × H)	4.49 × 2.66 × 1.44 114 × 67.5 × 36.5			With mounting ear 5.55 × 2.66 × 1.44 141 × 67.5 × 36.5
Net Weight	-	580 g	-	

**Note:** All specifications are tested by Cree XLamp XP-G and typical at 25°C unless otherwise stated.

## Dimming Specifications

Parameter	Min.	Typ.	Max.	Notes
Absolute Maximum Voltage on the V <sub>dim</sub> (+) Pin	-20 V	-	20 V	
Source Current on V <sub>dim</sub> (+)Pin	0 μA	200 μA	250 μA	
Dimming Output Range	10%I <sub>omax</sub>	-	100%I <sub>omax</sub>	
Recommended Dimming Input Range	0 V	-	10 V	

## Safety & EMC Compliance

Safety Category	Standard
UL/CUL	UL8750, UL 1310, CAN/CSA-C22.2 No. 250.13, CAN/CSA-C22.2 No. 223-M91
CE	EN 61347-1, EN61347-2-13
KS	KS C 7655
EMI Standards	Notes
EN 55015 <sup>(1)</sup>	Conducted emission Test & Radiated emission Test
EN 61000-3-2	Harmonic current emissions
EN 61000-3-3	Voltage fluctuations & flicker

## Safety & EMC Compliance (Continued)

EMI Standards	Notes
FCC Part 15 <sup>(1)</sup>	ANSI C63.4 Class B
	This device complies with Part 15 of the FCC Rules. Operation is subject to the following two conditions: [1] this device may not cause harmful interference, and [2] this device must accept any interference received, including interference that may cause undesired operation.
EMS Standards	Notes
EN 61000-4-2	Electrostatic Discharge (ESD): 8 kV air discharge, 4 kV contact discharge
EN 61000-4-3	Radio-Frequency Electromagnetic Field Susceptibility Test-RS
EN 61000-4-4	Electrical Fast Transient / Burst-EFT
EN 61000-4-5	Surge Immunity Test: AC Power Line: Differential Mode 4 kV, Common Mode 6 kV
EN 61000-4-6	Conducted Radio Frequency Disturbances Test-CS
EN 61000-4-8	Power Frequency Magnetic Field Test
EN 61000-4-11	Voltage Dips
EN 61547	Electromagnetic Immunity Requirements Applies To Lighting Equipment

**Note:** (1) This LED driver meets the EMI specifications above, but EMI performance of a luminaire that contains it depends also on the other devices connected to the driver and on the fixture itself.

## Lifetime vs. Case Temperature

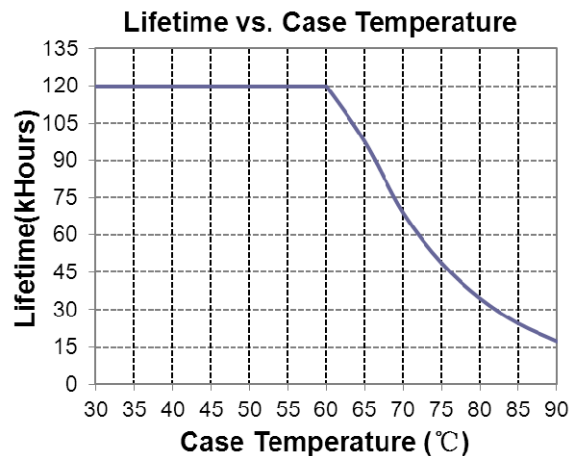

## Inrush Current Waveform

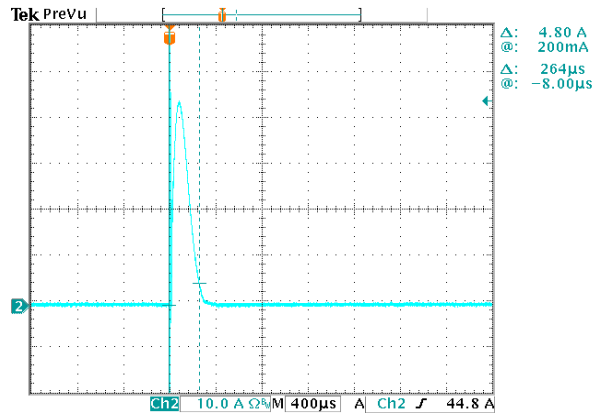

## Efficiency vs. Load

EUC-042S035DTM(STM)

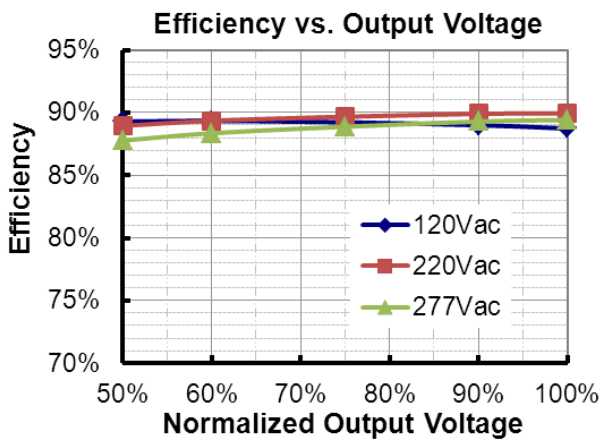

EUC-042S070DTM(STM)

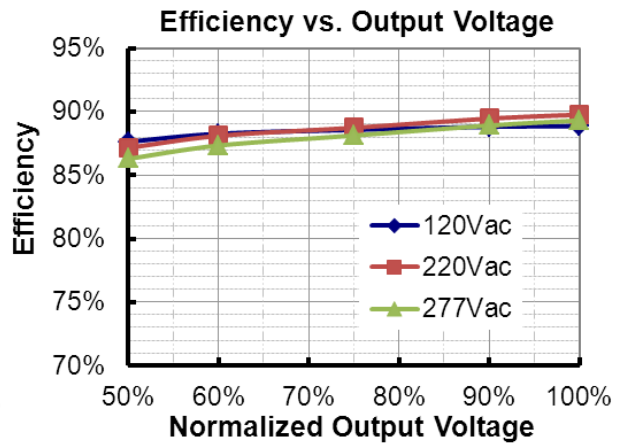

EUC-042S105DTM(STM)

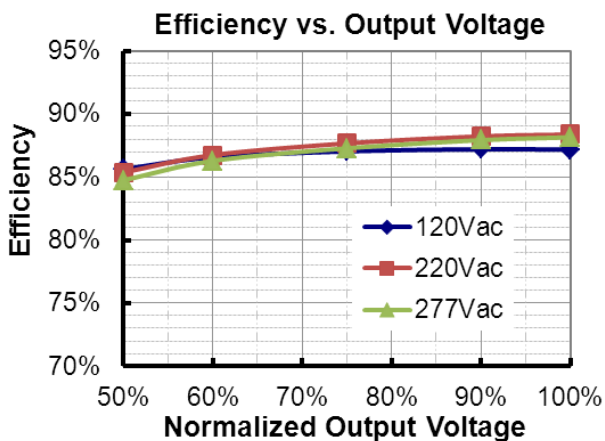

EUC-042S140DTM(STM)

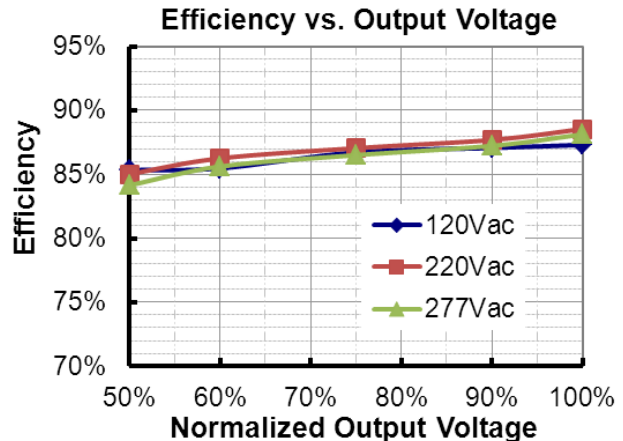

## Power Factor

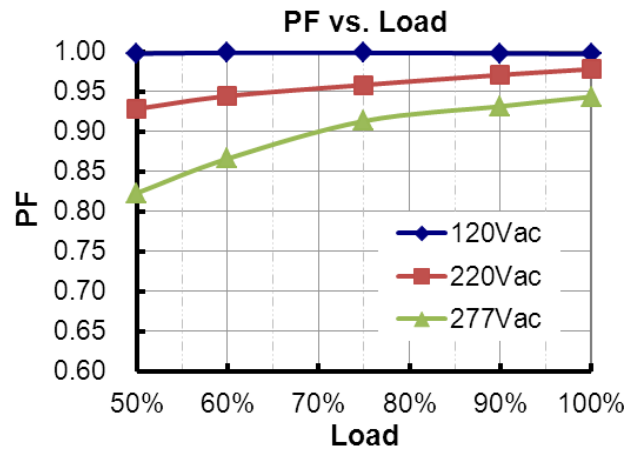

## Total Harmonic Distortion

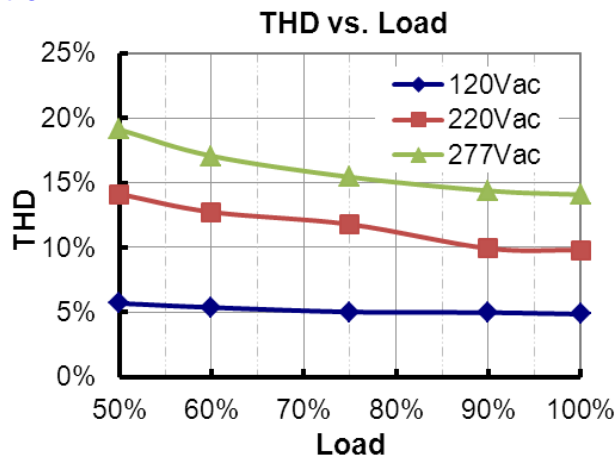

## Protection Functions

Parameter	Notes
Over Temperature Protection	Decreases output current, returning to normal after over temperature is removed.
Short Circuit Protection	Auto Recovery. No damage will occur when any output is short circuited. The output shall return to normal when the fault condition is removed.
Over Voltage Protection	Limits output voltage at no load and in case the normal voltage limit fails.

## Dimming

### ● 0-10V Dimming

Recommended implementations of the dimming control are provided below.

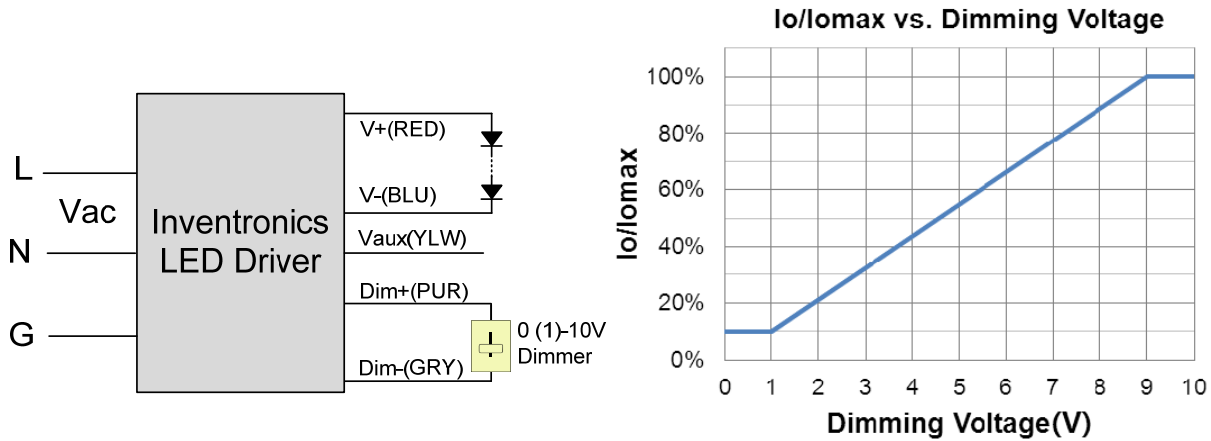

Implementation 1: DC Input

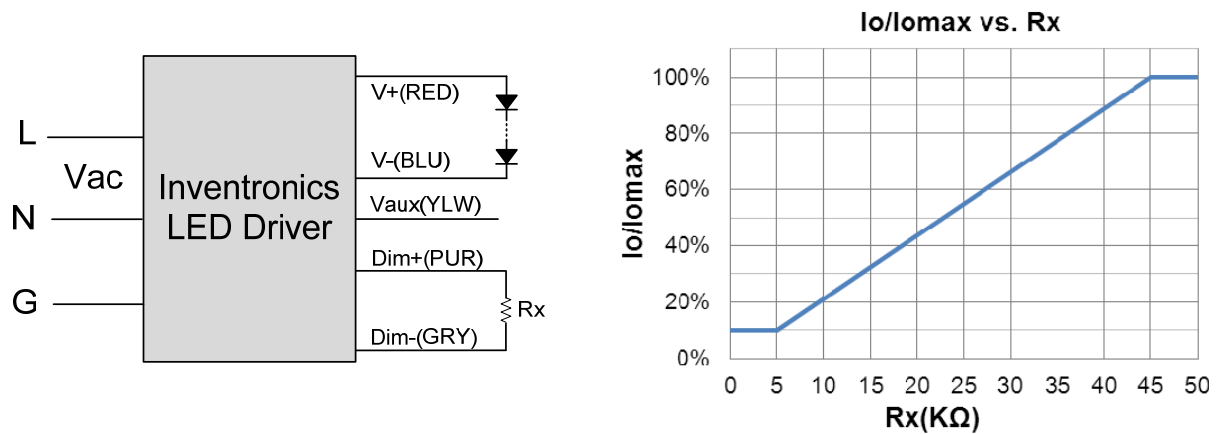

Implementation 2: External Resistor

**Notes:**

1. The dimmer can also be replaced by an active 0-10V voltage source signal or passive components like resistors and zener.
2. Do NOT connect Dim- to the output V- or V+, otherwise the driver will not work properly.
3. If 0-10V dimming is not used, Dim + can be either open or connected to Vaux.

## Mechanical Outline

### EUC-042SxxxDTM

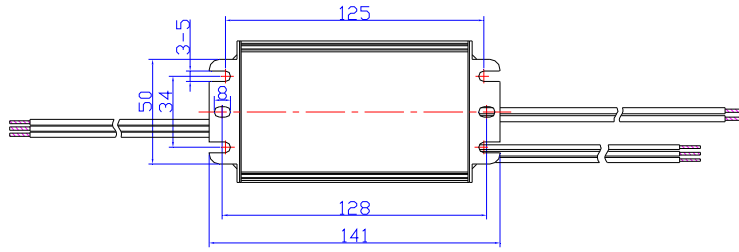
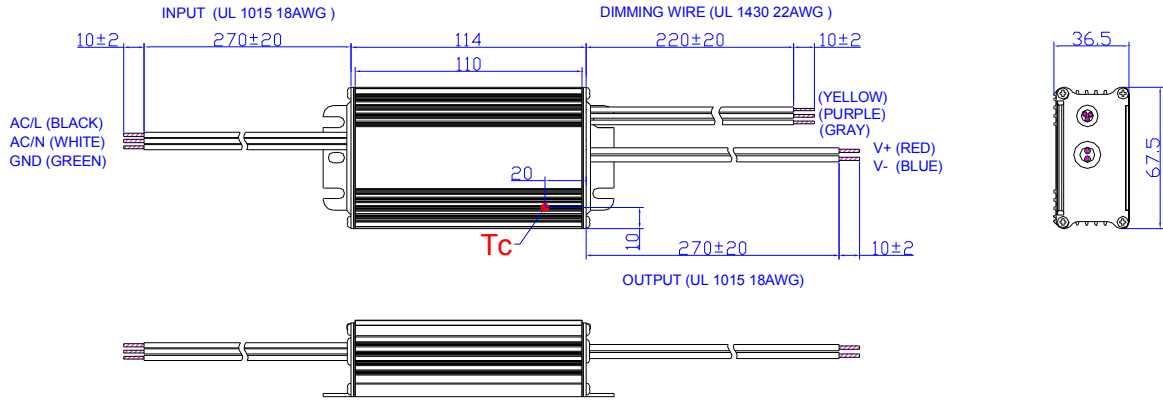

PROJ. Unspecified tolerance:±1

### EUC-042SxxxSTM

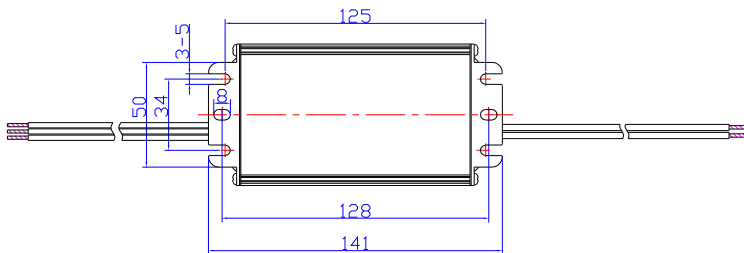
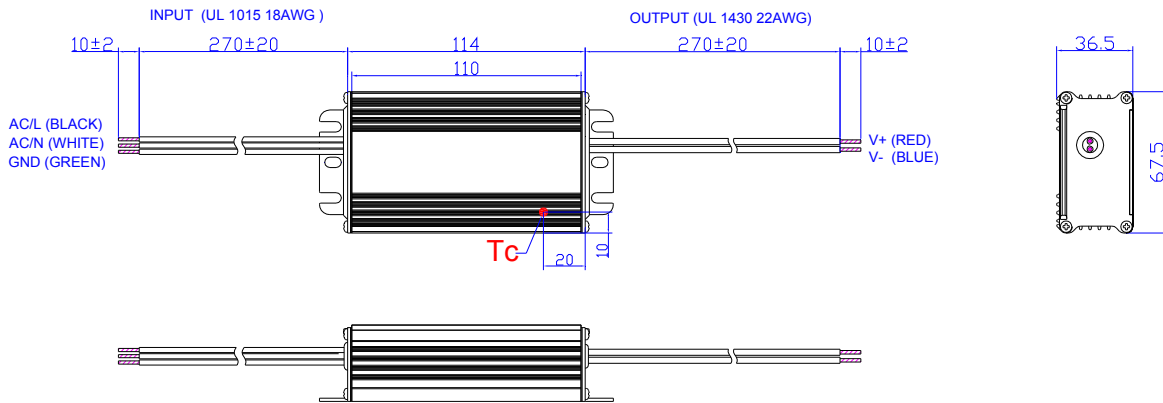

PROJ. Unspecified tolerance:±1



## **RoHS Compliance**

Our products comply with reference to RoHS Directive (EU) 2015/863 amending 2011/65/EU, calling for the elimination of lead and other hazardous substances from electronic products.

## Revision History

Change Date	Rev.	Description of Change		
		Item	From	To
2015-01-12	A	Datasheet Release	/	/
2016-04-18	B	Lifetime	120,000Hours at Tc=60°C	69,000 Hours at Tc=70°C
		Net Weight	500 g	580 g
		Source Current on Vdim (+)Pin Max.	220 uA	250 uA
		KS Certificate Regulation	/	Added
		Note of EMI Standard	/	Added
2019-08-20	C	Features	Surge Protection Level	Updated
		Description	/	Updated
		Models	Notes(1)	Updated
		Input Specifications(PF/THD)	50-60Hz	Added
		Safety &EMC Compliance	UL/CUL	Updated
		Safety &EMC Compliance	KS	Updated
		Safety &EMC Compliance	EN 61000-3-2	Updated
		Safety &EMC Compliance	FCC	Updated
		Safety &EMC Compliance	EN 61000-4-5	Updated
		Mechanical Outline	/	Updated
RoHS Compliance	/	Updated		