

Features

- High Efficiency (Up to 90%)
- Active Power Factor Correction (0.99 Typical)
- Constant Current Output
- 0-10V Dimming Control
- Input surge protection: DM 4kV, CM 6kV
- All-Around Protection: OVP, SCP, OTP
- IP67 and Dry / Damp / Wet Location
- TYPE HL, for use in a Class I, Division 2 hazardous (Classified) location



Description

The EUC-075SxxxDT(ST) series is a 75W, constant-current LED driver that operates from 90-305 Vac input with excellent power factor. It is created for many lighting applications including low bay, tunnel and street, etc. The high efficiency of these drivers and compact metal case enables them to run cooler, significantly improving reliability and extending product life. To ensure trouble-free operation, protection is provided against input surge, output over voltage, short circuit, and over temperature.

Models

Output Current	Input Voltage Range(1)	Output Voltage Range	Max. Output Power	Typical Efficiency (2)	Power Factor		Model Number
					120Vac	220Vac	
350 mA	90 ~ 305 Vac 127 ~ 300 Vdc	107~214 Vdc	75 W	90%	0.99	0.96	EUC-075S035DT(ST) ⁽³⁾
450 mA	90 ~ 305 Vac 127 ~ 300 Vdc	83~166 Vdc	75 W	90%	0.99	0.96	EUC-075S045DT(ST) ⁽³⁾
700 mA	90 ~ 305 Vac 127 ~ 300 Vdc	54~108 Vdc	75 W	90%	0.99	0.96	EUC-075S070DT(ST) ⁽³⁾
1050 mA	90 ~ 305 Vac 127 ~ 300 Vdc	36 ~72 Vdc	75 W	89%	0.99	0.96	EUC-075S105DT(ST) ⁽³⁾
1400 mA	90 ~ 305 Vac 127 ~ 300 Vdc	27 ~54 Vdc	75 W	89%	0.99	0.96	EUC-075S140DT(ST) ⁽⁴⁾
2100 mA	90 ~ 305 Vac 127 ~ 300 Vdc	18 ~36 Vdc	75 W	88%	0.99	0.96	EUC-075S210DT(ST) ⁽⁴⁾
2800 mA	90 ~ 305 Vac 127 ~ 300 Vdc	13 ~27 Vdc	75 W	88%	0.99	0.96	EUC-075S280DT ⁽⁵⁾ (ST) ⁽³⁾
3150mA	90 ~ 305 Vac 127 ~ 300 Vdc	12~24 Vdc	75 W	88%	0.99	0.96	EUC-075S315DT(ST) ⁽⁵⁾⁽⁶⁾
3750 mA	90 ~ 305 Vac 127 ~ 300 Vdc	10 ~20 Vdc	75 W	87%	0.99	0.96	EUC-075S375DT(ST) ⁽⁵⁾
5000 mA	90 ~ 305 Vac 127 ~ 300 Vdc	7 ~15 Vdc	75 W	86%	0.99	0.96	EUC-075S500DT(ST) ⁽⁵⁾

- Notes:** (1) Certified input Voltage range 100-240Vac for CE only.
 (2) Measured at 100% load and 220 Vac input.
 (3) Non-Class2 output (USR & CNR).
 (4) Class 2 output (USR & CNR) for Dry and Damp location.
 (5) Class 2 output (USR & CNR) for Dry, Damp and Wet location.
 (6) EUC-075S315DT(ST) are certificated to UL and KS.

Input Specifications

Parameter	Min.	Typ.	Max.	Notes
Input Voltage	90 Vac	-	305 Vac	127 ~ 300 Vdc
Input Frequency	47 Hz	-	63 Hz	
Leakage Current	-	-	0.75 mA	At 277Vac 60Hz input
Input AC Current	-	-	0.9 A	Measured at 100%load and 100 Vac input.
	-	-	0.42 A	Measured at 100%load and 220 Vac input.
Inrush Current	-	-	60 A	At 220Vac input, 25°C cold start, duration=1 ms, 10%lpk-10%lpk.
Inrush Current(I ² t)	-	-	1 A ² s	
Power Factor	0.90	-	-	At 100Vac-277Vac, 50-60Hz,100%Load
THD	-	-	20%	

Output Specifications

Parameter	Min.	Typ.	Max.	Notes
Output Current Range	-5%	-	5%	
Ripple and Noise (pk-pk)	-	-	5% V _O	Measured by 20 MHz bandwidth oscilloscope and the output paralleled a 0.1 uF ceramic capacitor and a 10 uF electrolytic capacitor. V _O is the maximum output voltage.
Output Current Ripple at < 200 Hz (pk-pk)	-	1%I _O	-	At 100%load condition. Only this component of ripple is associated with visible flicker.
No Load Output Voltage				
I _O = 350 mA	-	224 V	-	
I _O = 450 mA	-	172 V	-	
I _O = 700 mA	-	112 V	-	
I _O = 1050 mA	-	76 V	-	
I _O = 1400 mA	-	58 V	-	
I _O = 2100 mA	-	40 V	-	
I _O = 2800 mA	-	34 V	-	
I _O = 3150 mA	-	28V	-	
I _O = 3750 mA	-	25 V	-	
I _O = 5000 mA	-	19 V	-	
Line Regulation	-	-	±1%	
Load Regulation	-	-	±3%	
Turn-on Delay Time	-	0.8 s	1.2 s	Measured at 120Vac input.
	-	0.4 s	0.6 s	Measured at 220Vac input.
Temperature coefficient	-	-	0.06%/°C	Case temperature = 0°C ~T _c max

Protection Functions

Parameter	Min.	Typ.	Max.	Notes
Over Temperature Protection-Tc	-	100 °C	-	Latch mode. The power supply shall return to normal operation only after the power is turn-on again.
Short Circuit Protection	No damage shall occur when any output operating in a short circuit condition. The power supply shall be self-recovery when the fault condition is removed.			

General Specifications

Parameter	Min.	Typ.	Max.	Notes
Efficiency at 120 Vac Io = 350 mA Io = 450 mA Io = 700 mA Io = 1050 mA Io = 1400 mA Io = 2100 mA Io = 2800 mA Io = 3150 mA Io = 3750 mA Io = 5000 mA	86% 86% 86% 85% 85% 84% 84% 84% 83% 82%	88% 88% 88% 87% 87% 86% 86% 86% 85% 84%	- - - - - - - - - -	Measured at 100%load, 120Vac input, 25°C ambient temperature, after the unit is thermally stabilized. It will be lower about 2%, if measured immediately after startup.
Efficiency at 220 Vac Io = 350 mA Io = 450 mA Io = 700 mA Io = 1050 mA Io = 1400 mA Io = 2100 mA Io = 2800 mA Io = 3150 mA Io = 3750 mA Io = 5000 mA	88% 88% 88% 87% 87% 86% 86% 86% 85% 84%	90% 90% 90% 89% 89% 88% 88% 88% 87% 86%	- - - - - - - - - -	Measured at 100%load, 220Vac input, 25°C ambient temperature, after the unit is thermally stabilized. It will be lower about 2%, if measured immediately after startup.
MTBF	-	320,000 hours	-	Measured at 120Vac input, 80%Load and 25°C ambient temperature (MIL-HDBK-217F)
Lifetime	Io=3150 mA	-	103,000 hours	Measured at 120Vac input, 80%Load; Case temperature=60°C @ Tc point. See life time vs. Tc curve for the details
	Others	-	107,000 hours	
Operating Case Temperature for Safety Tc_s	-40 °C	-	+87°C (DT series)	350mA,450mA,700mA,1050mA:90°C other models:87°C
	-40 °C	-	+88°C (ST series)	350mA,450mA,700mA,1050mA:88°C other models: 90°C
Operating Case Temperature for Warranty Tc_w	-40 °C	-	+70°C	
Storage Temperature	-40 °C	-	+85 °C	Humidity: 5% RH to 100% RH
Dimensions Inches (L x W x H) Millimeters (L x W x H)	5.91 x 2.66 x 1.44 150 x 67.5 x 36.5			With mounting ear 6.97 x 2.66 x 1.44 177 x 67.5 x 36.5
Net Weight	-	780 g	-	

Safety & EMC Compliance

Safety Category	Standard
UL/CUL	UL8750, UL 1310, CAN/CSA-C22.2 No. 250.13, CAN/CSA-C22.2 No. 223-M91
CE	EN 61347-1, EN 61347-2-13
KS	KS C 7655
EMI Standards	Notes
EN 55015 ⁽¹⁾	Conducted emission Test & Radiated emission Test
EN 61000-3-2	Harmonic current emissions
EN 61000-3-3	Voltage fluctuations & flicker
FCC Part 15 ⁽¹⁾	ANSI C63.4 Class B
	This device complies with Part 15 of the FCC Rules. Operation is subject to the following two conditions: [1] this device may not cause harmful interference, and [2] this device must accept any interference received, including interference that may cause undesired Operation.
EMS Standards	Notes
EN 61000-4-2	Electrostatic Discharge (ESD): 8 kV air discharge, 4 kV contact discharge
EN 61000-4-3	Radio-Frequency Electromagnetic Field Susceptibility Test-RS
EN 61000-4-4	Electrical Fast Transient / Burst-EFT
EN 61000-4-5	Surge Immunity Test: AC Power Line: Differential Mode 4 kV, Common Mode 6 kV
EN 61000-4-6	Conducted Radio Frequency Disturbances Test-CS
EN 61000-4-8	Power Frequency Magnetic Field Test
EN 61000-4-11	Voltage Dips
EN 61547	Electromagnetic Immunity Requirements Applies to Lighting Equipment
ENERGY STAR Standards	Notes
ANSI/IEEE C62.41-1991	Transient Protection, power supply shall comply with Class A operation. The line transient shall consist of seven strikes of a 100 kHz ring wave, 2.5 kV level, for both common mode and differential mode.

Note: (1) This LED driver meets the EMI specifications above, but EMI performance of a luminaire that contains it depends also on the other devices connected to the driver and on the fixture itself.

Lifetime vs. Case Temperature

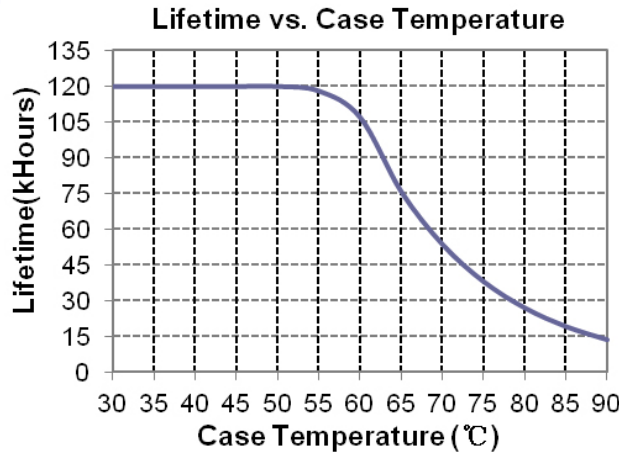

Efficiency vs Load

EUC-075S035DT(ST)

Efficiency vs. Output Voltage

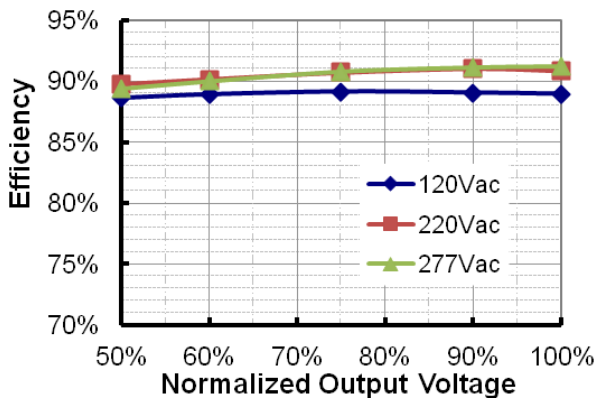

EUC-075S045DT(ST)

Efficiency vs. Output Voltage

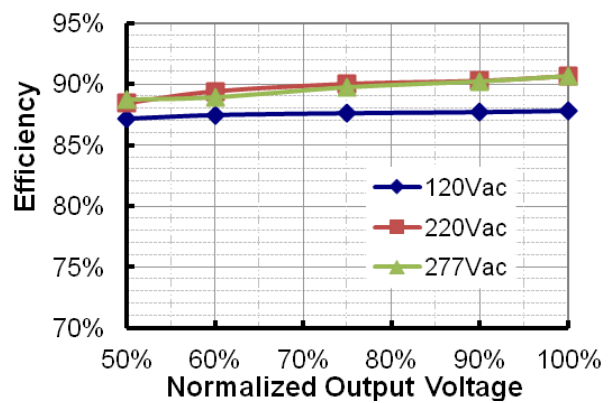

EUC-075S070DT(ST)

Efficiency vs. Output Voltage

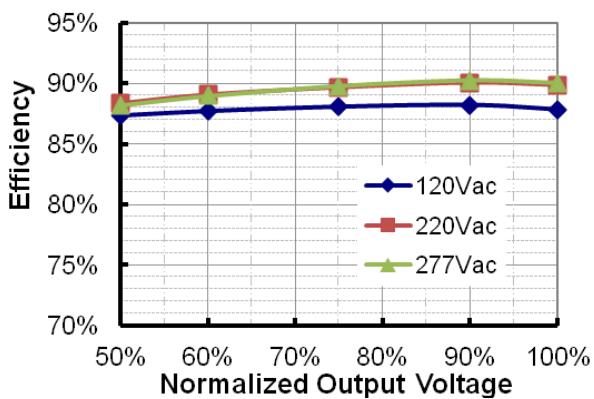

EUC-075S105DT(ST)

Efficiency vs. Output Voltage

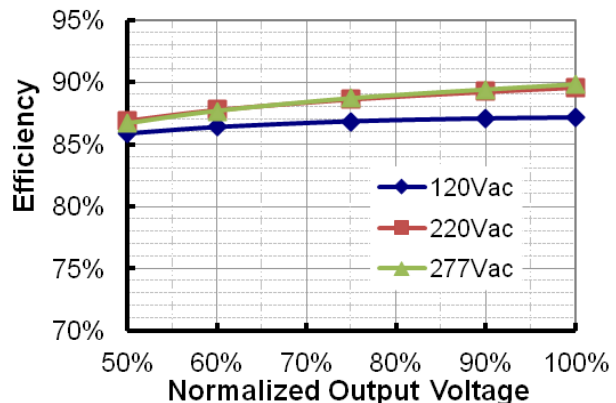

EUC-075S140DT(ST)

Efficiency vs. Output Voltage

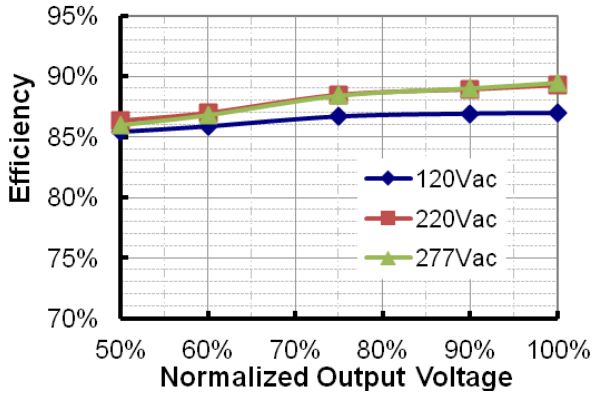

EUC-075S210DT(ST)

Efficiency vs. Output Voltage

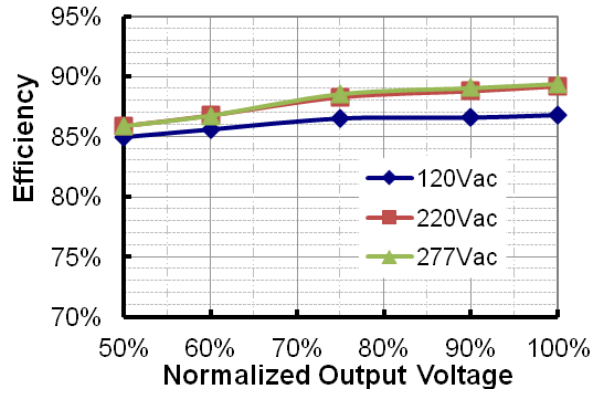

EUC-075S280DT(ST)

Efficiency vs. Output Voltage

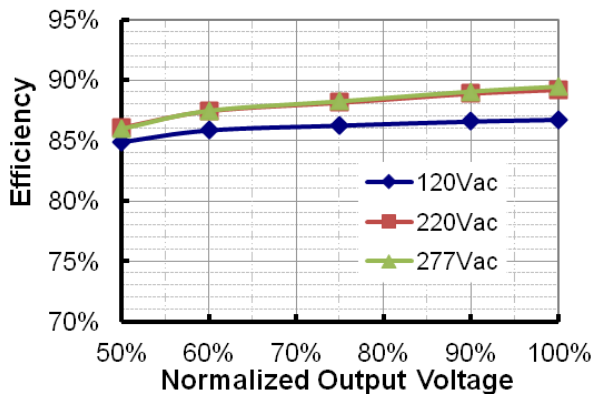

EUC-075S315DT(ST)

Efficiency vs. Output Voltage

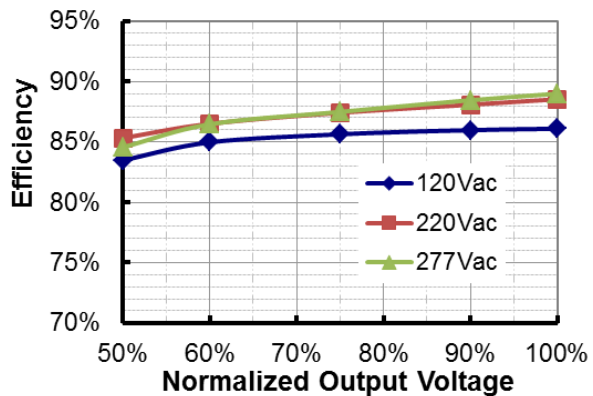

EUC-075S375DT(ST)

Efficiency vs. Output Voltage

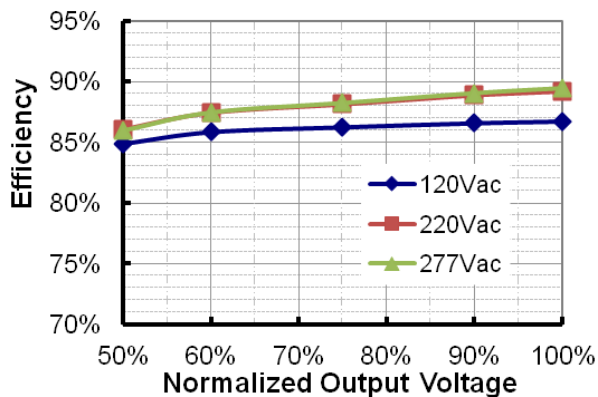

EUC-075S500DT(ST)

Efficiency vs. Output Voltage

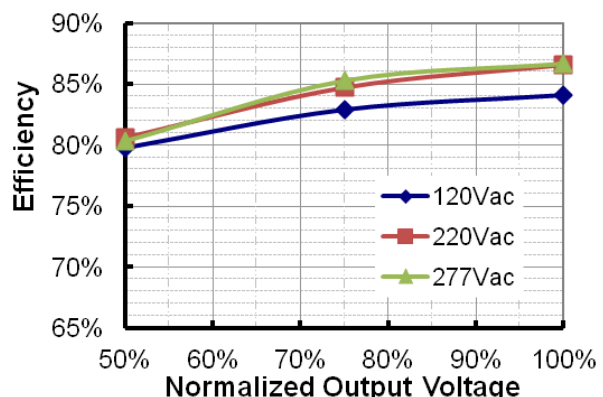

Power Factor Characteristics

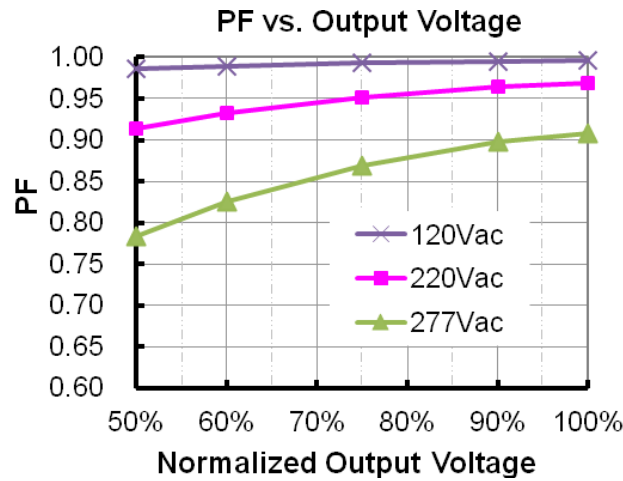

Total Harmonic Distortion

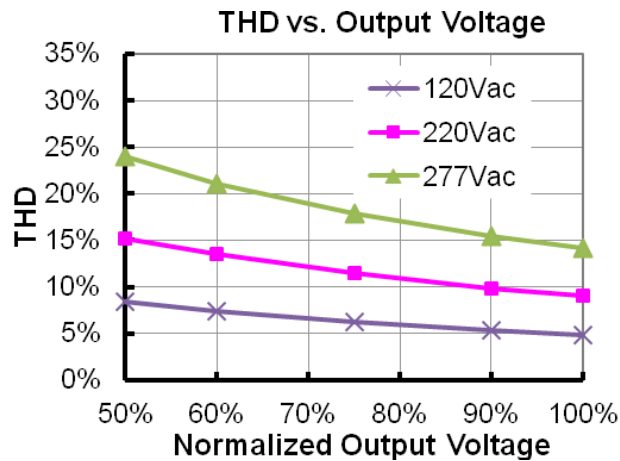

Dimming

Parameter	Min.	Typ.	Max.	Notes
10V output voltage	9.8 V	10 V	10.2 V	
10V output source current	0 mA	-	10 mA	
Absolute maximum voltage on the 1~10V input pin	-2 V	-	12 V	
Source current on 1~10V input pin	0 mA	-	0.5 mA	
Value of Rin (the resistor inside the LED driver which locate between the 1-10V input and 10V output pin)	19.8 K	20 K	20.2 K	

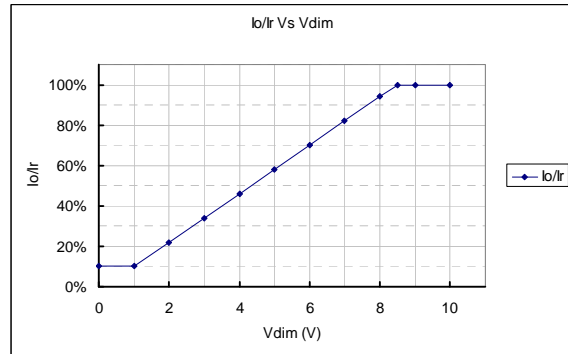
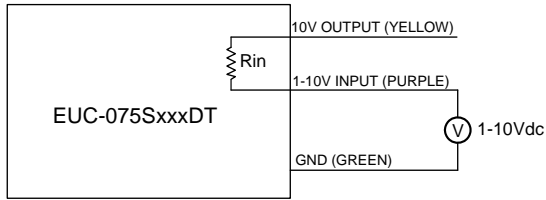

Implementation 1: DC input

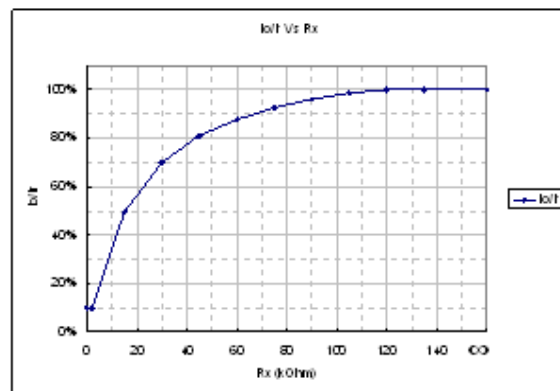
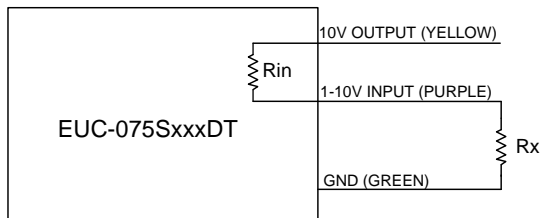

Implementation 2: External resistor

Notes:

1. If the dimming function is not used, please let the dimming leads floated; the output is full load when the dimming leads are floated.
2. I_o is actual output current and I_r is rated current without dimming control.
3. For the driver to operate properly, the load voltage must be maintained above the minimum voltage threshold (approx. 50% of the max. output voltage for any given model).
4. If the output voltage is maintained above 50% of the maximum output voltage, the dimming control may be operated over the entire 1-10V range with output current varying from 100% down to practically 10%.
5. The dimming signal is allowed to be less than 1V, however, when it for 0-1V, the output current can maintain about 10% I_r . When it for 8.5-10V, the output current can maintain about 100% I_r .
6. Do not connect the GND of dimming to the output; otherwise, the LED driver can not work normally.
7. Do not connect the GND of dimming to the output; otherwise, the LED driver can not work normally.

Mechanical Outline

EUC-075SxxxDT

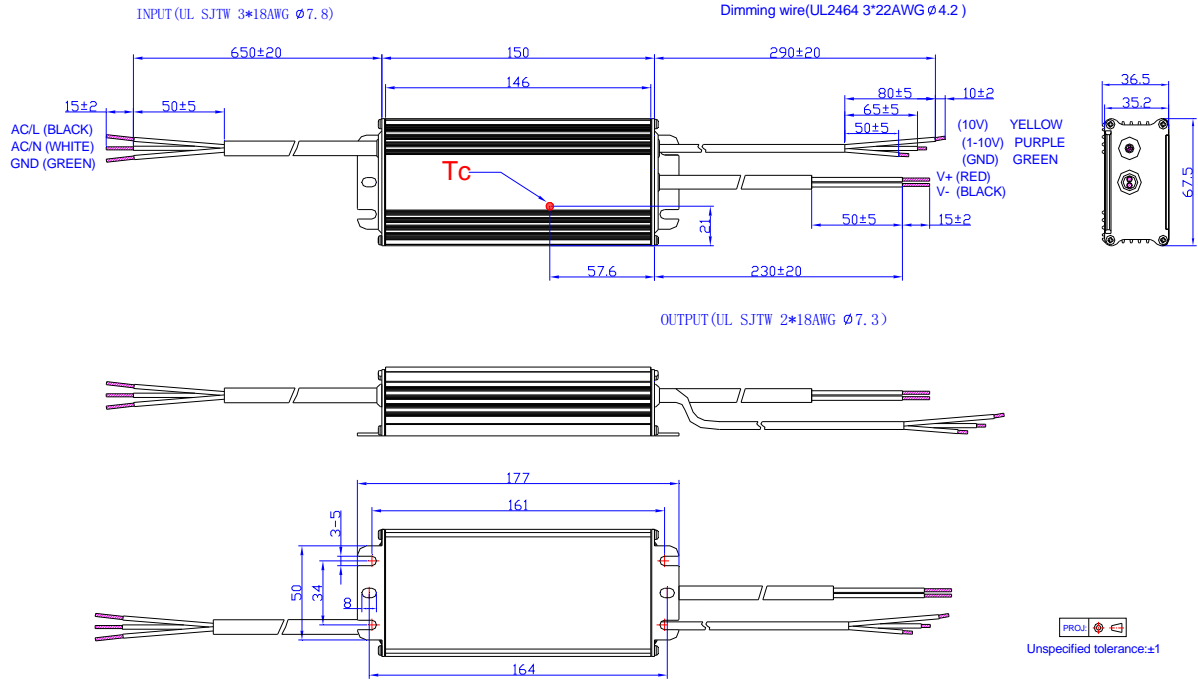

EUC-075SxxxST

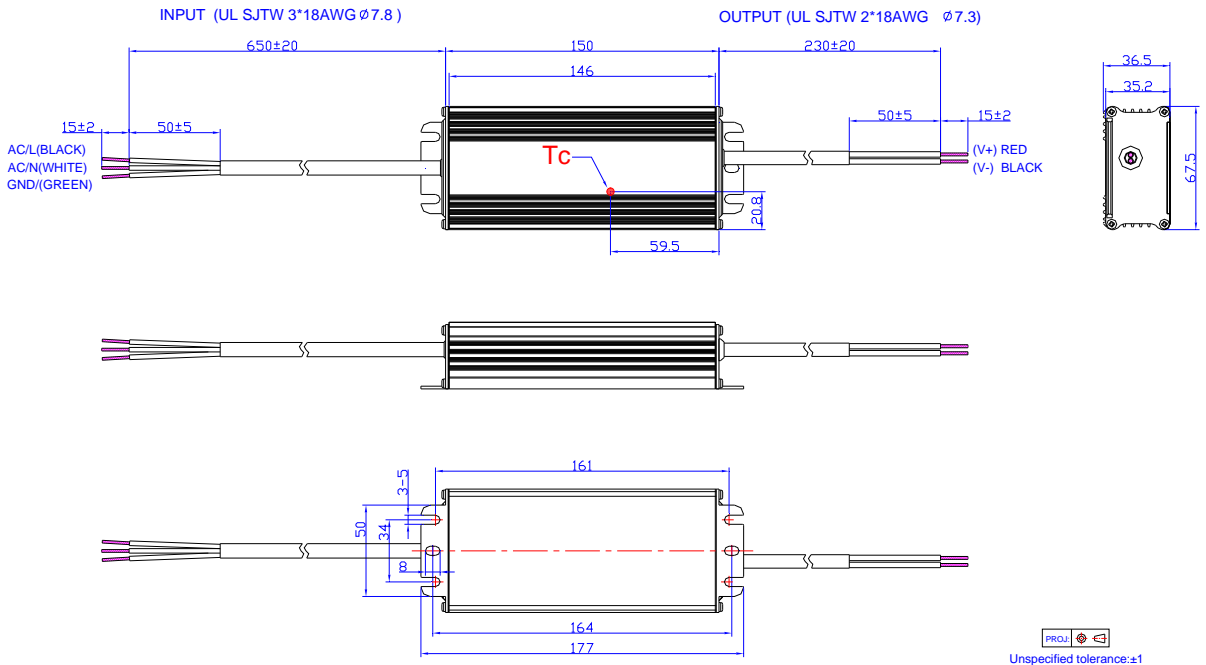

RoHS Compliance

Our products comply with reference to RoHS Directive (EU) 2015/863 amending 2011/65/EU, calling for the elimination of lead and other hazardous substances from electronic products.

Revision History

Change Date	Rev.	Description of Change		
		Item	From	To
2010-03-03	A	Add notes of UL1310 Class 2 for all models. (3) (4) (5)		
		Change efficiency for all models		
		Change MTBF	498,000 hours	450,000 hours
		Add Leakage Current in Input Specifications	/	/
		Add Derating Curve	/	/
		Modify the tin-plated wire length tolerance in Mechanical Outline	±0.5	±2
		Add one note in Dimming Control	/	7. Do not connect the GND of dimming to the output; otherwise, the LED driver can not work normally.
2010-05-25	B	Add one item in the notes of Ripple and Noise (pk-pk)	/	Vo is the maximum output voltage.
		Delete Output Overshoot / Undershoot	Max. 10%	/
2010-05-31	C	Add star rank for recommended models	/	☆: Popular model.
		Standardize the tolerance in Mechanical Outline	/	/
2010-07-30	D	Add Energy Star Standard	/	Comply With ANSI/IEEE C62.41, Class A Operation
2010-08-10	F	Change Turn-on Delay Time 120Vac input	Typ. 0.5S Max. 0.8S	Typ. 0.8S Max. 1.2S
2010-10-22	G	Update the part of dimming control	/	/
2010-11-12	H	Change efficiency of 5000 mA	Min. 84%, Typ. 86%	Min. 82%, Typ. 84%
		110 Vac 220 Vac	86%, 88%	84%, 86%
		Add another dimming version with pull-down resistor	/	/
2011-01-14	I	Change popular models	/	/
2012-06-10	J	Life time curve	/	Added
		EN61000-4-5	line to line 2 kV, line to earth 4 kV	line to line 4 kV, line to earth 6 kV
		Efficiency of some models	/	1% or 2% lower
2012-7-5	k	Inrush Current	50 A	60 A
2012-7-17	L	Max Case Temperature	/	Updated
2012-10-10	M	Min PF, Max THD	/	Added
		Temperature coefficient	/	Added
		MTBF, Life time Typical Value	/	Added
		Life Time Curve	/	Updated
		Operating Temperature	-35°C	-40°C

Revision History

Change Date	Rev.	Description of Change		
		Item	From	To
2012-10-10	M	Derating Curve	/	Updated
2013-05-23	N	Product photo	/	Updated
		Details of Class 2 description	/	Updated
		Leakage current	1mA	0.75mA
		No load voltage-typical	/	Added
		OVP	/	Deleted
		Efficiency of 5000mA Model	/	1%lower
		Typical value of OTP	110°C	100°C
		Max value of case temperature	/	Corrected
		Efficiency curve	/	Added
		PF curve	/	Added
		THD curve	/	Added
		Dimming control- With pull-up resistor dimming curve	/	Updated
Mechanical outline	/	Updated		
2015-03-02	O	Format	/	Updated
		Features	/	Updated
		Description	/	Updated
		Models	Notes	Updated
		General Specifications	Case Temperature	Operating Case Temperature for Safety Tc_s
		General Specifications	Operating Case Temperature for Warranty Tc_w	Added
		With pull-down resistor: (The model number has a suffix -0040)	/	Delete
		Mechanical Outline	/	Updated
2016-04-20	P	KS	/	Added
		General Specifications	Output Current Ripple at < 200 Hz (pk-pk)	Added
		General Specifications	Storage Temperature	Added
		General Specifications	With mounting ear	Added
		General Specifications	Net Weight	Updated
		Environmental Specifications	/	Delete

Revision History

Change Date	Rev.	Description of Change		
		Item	From	To
2016-04-20	P	Safety & EMC Compliance	/	Updated
2017-05-23	Q	Models	3150 mA	Added
		Models	Note	Updated
		Output Specifications	No Load Output Voltage	Added
		General Specifications	Efficiency	Added
		Efficiency vs Load	EUC-075S315DT(ST)	Added
		Mechanical Outline	/	Updated
2020-01-13	R	Features	4kV line-line, 6kV line-earth	DM 4kV, CM 6kV
		Features	Waterproof (IP67)	IP67
		Description	Application environment	Updated
		Input Specifications-PF/THD(Notes)	50-60Hz,	Added
		Safety & EMC Compliance	EN 61000-4-5	Updated
		Derating	/	Deleted
		RoHS Compliance	/	Updated
		Format	Page footer	Updated