

Features

- Ultra High Efficiency (Up to 92%)
- Three Channels Output
- Active Power Factor Correction (0.99 Typical)
- Constant Current Output
- Input Surge Protection: DM 4kV, CM 6kV
- All-Around Protection: SCP, OTP, OVP
- IP67 and UL Dry / Damp / Wet Location
- SELV Output
- 5 Years Warranty



Description

The EUC-120TxxxDV(SV) series is a 120W, three-channel, constant current LED driver that operates from 90-305 Vac input with excellent power factor. It is created for many lighting applications including flood, tunnel and street, etc. The high efficiency of these drivers and compact metal case enables them to run cooler, significantly improving reliability and extending product life. To ensure trouble-free operation, protection is provided against input surge, output over voltage, short circuit, and over temperature.

Models

Output Current (1)	Input Voltage Range(2)	Output Voltage Range	Max. Output Power	Typical Efficiency (3)	Power Factor		Model Number
					120Vac	220Vac	
350 mA	90 ~ 305 Vac	57~103Vdc	108 W	92.0%	0.99	0.94	EUC-120T035DV(SV)
450 mA	90 ~ 305 Vac	45~90 Vdc	120 W	92.0%	0.99	0.94	EUC-120T045DV(SV)
600 mA	90 ~ 305 Vac	40~70 Vdc	126 W	91.0%	0.99	0.94	EUC-120T060DV(SV)
700 mA	90 ~ 305 Vac	29~57 Vdc	120 W	91.0%	0.99	0.94	EUC-120T070DV(SV)
1050 mA	90 ~ 305 Vac	19~38 Vdc	120 W	90.0%	0.99	0.94	EUC-120T105DV(SV)
1400 mA	90 ~ 305 Vac	14~29 Vdc	120 W	89.5%	0.99	0.94	EUC-120T140DV(SV)

Notes: (1) The output current is adjustable at factory from 50% to 100%.

(2) Certified input Voltage range 100-240Vac.

(3) Measured at 100% load and 220 Vac input.

Input Specifications

Parameter	Min.	Typ.	Max.	Notes
Input Voltage	90 V	-	305 V	
Input Frequency	47 Hz	-	63 Hz	
Leakage Current	-	-	1 mA	At 277Vac 60Hz input
Input AC Current	-	-	1.51 A	Measured at 100% load and 100 Vac input.
	-	-	0.7 A	Measured at 100% load and 220 Vac input.

Input Specifications (Continued)

Parameter	Min.	Typ.	Max.	Notes
Inrush current	-	-	65 A	At 220Vac input, 25°C cold start, duration=0.8 ms, 10%Ipk-10%Ipk.
Inrush Current(I ² t)	-	-	2.4 A ² s	
Power Factor	0.90	-	-	At 100-277Vac, 50-60Hz, 75%-100% Load
THD	-	-	20%	

Output Specifications

Parameter	Min.	Typ.	Max.	Notes
Output channel	-	3	-	
Output Current Tolerance	-5%	-	5%	
No-load Output Voltage I _o = 350 mA I _o = 450 mA I _o = 600 mA I _o = 700 mA I _o =1050 mA I _o =1400 mA	- - - - - -	- - - - - -	110 V 97 V 77 V 64 V 51 V 50.5 V	Hiccup mode.
Output Current Ripple (pk-pk)	-	-	15% I _o	Peak to peak value, rated by output current. At full load condition.
Output Overshoot / Undershoot	-	-	10%	When power on or off.
Line Regulation	-	-	± 1%	
Load Regulation	-	-	± 3%	
Turn-on Delay Time	-	2.0 s	3.0 s	Measured at 120Vac input, 75%-100% Load
	-	2.0 s	3.0 s	Measured at 220Vac input, 75%-100% Load
Temperature Coefficient	-	0.03%/°C	-	Case temperature = 0°C ~T _c max

Note: All specifications are typical at 25 °C unless otherwise stated.

Protection Functions

Parameter	Min.	Typ.	Max.	Notes
Over Temperature Protection	-	120 °C	-	When OTP occurs, the output current decreases down to the half of the normal output current. The output shall be auto recovery when case temperature becomes normal.
Short Circuit Protection	Single channel short does not affect the normal work of other channels. The driver recovers after short is removed and AC input recycled. Dual or triple channel short latches the driver and it recovers after the short is removed.			

General Specifications

Parameter	Min.	Typ.	Max.	Notes
Efficiency Io= 350 mA Io= 450 mA Io= 600 mA Io= 700 mA Io=1050 mA Io=1400 mA	87.0% 87.0% 87.0% 86.5% 86.5% 85.5%	89.0% 89.0% 89.0% 88.5% 88.5% 87.5%	- - - - - -	Measured at 100% load, 120Vac input, 25°C ambient temperature, after the unit is thermally stabilized. It will be about 2% lower, if measured immediately after startup.
Efficiency Io= 350 mA Io= 450 mA Io= 600 mA Io= 700 mA Io=1050 mA Io=1400 mA	90.0% 90.0% 89.0% 89.0% 88.0% 87.5%	92.0% 92.0% 91.0% 91.0% 90.0% 89.5%	- - - - - -	Measured at 100% load, 220Vac input, 25°C ambient temperature, after the unit is thermally stabilized. It will be about 2% lower, if measured immediately after startup.
Efficiency Io= 350 mA Io= 450 mA Io= 600 mA Io= 700 mA Io=1050 mA Io=1400 mA	90.0% 90.0% 89.0% 89.0% 88.0% 87.5%	92.0% 92.0% 91.0% 91.0% 90.0% 89.5%	- - - - - -	Measured at 100% load, 277Vac input, 25°C ambient temperature, after the unit is thermally stabilized. It will be about 2% lower, if measured immediately after startup.
MTBF	-	288,000 Hours	-	Measured at 220Vac input, 80%Load and 25°C ambient temperature (MIL-HDBK-217F)
Lifetime	-	98,000 Hours	-	Measured at 220Vac input, 80%Load; Case temperature=60°C @ Tc point. See lifetime vs. Tc curve for the details
Operating Case Temperature for Safety Tc_s	-40°C	-	+90 °C	
Operating Case Temperature for Warranty Tc_w	-40°C	-	+70 °C	Case temperature for 5 years warranty
Storage Temperature	-40°C	-	+85 °C	Humidity: 5% RH to 100% RH
Dimensions Inches (L × W × H) Millimeters (L × W × H)		7.40 × 3.46 × 1.50 188 × 88 × 38		With mounting ear 8.35 × 3.46 × 1.50 212 × 88 × 38
Net Weight	-	1240 g	-	

Note: All specifications are typical at 25 °C unless otherwise stated.

Safety & EMC Compliance

Safety Category	Standard
TUV&CE	EN 61347-1, EN 61347-2-13
CB	IEC 61347-1, IEC 61347-2-13
KS	KS C 7655
EMI Standards	Notes
EN 55015 ⁽¹⁾	Conducted emission Test & Radiated emission Test
EN 61000-3-2	Harmonic current emissions
EN 61000-3-3	Voltage fluctuations & flicker

Safety & EMC Compliance (Continued)

EMS Standards	Notes
EN 61000-4-2	Electrostatic Discharge (ESD): 15 kV air discharge, 8 kV contact discharge
EN 61000-4-3	Radio-Frequency Electromagnetic Field Susceptibility Test-RS
EN 61000-4-4	Electrical Fast Transient / Burst-EFT
EN 61000-4-5	Surge Immunity Test: AC Power Line: Differential Mode 4 kV, Common Mode 6 kV
EN 61000-4-6	Conducted Radio Frequency Disturbances Test-CS
EN 61000-4-8	Power Frequency Magnetic Field Test
EN 61000-4-11	Voltage Dips
EN 61547	Electromagnetic Immunity Requirements Applies To Lighting Equipment

Note: (1) This LED driver meets the EMI specifications above, but EMI performance of a luminaire that contains it depends also on the other devices connected to the driver and on the fixture itself.

Lifetime vs. Case Temperature Curve

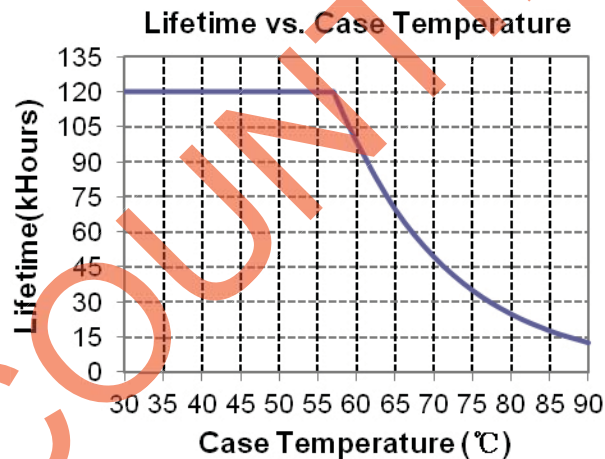

Efficiency vs. Load

EUC-120T035DV(SV)

Efficiency vs. Output Voltage

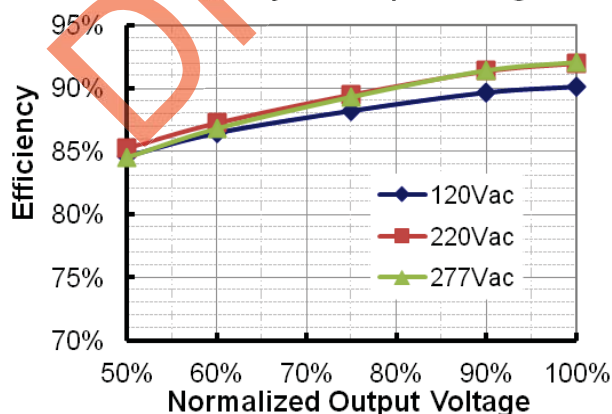

EUC-120T045DV(SV)

Efficiency vs. Output Voltage

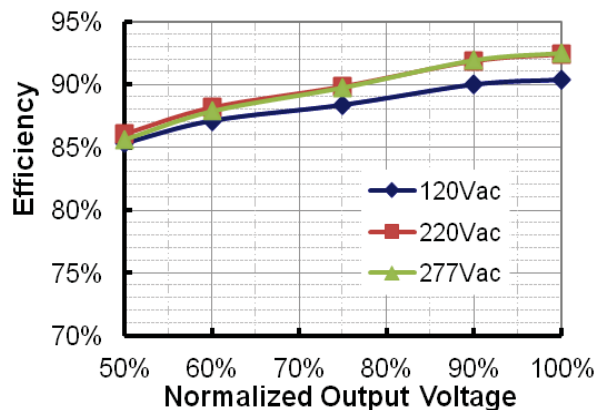

EUC-120T060DV(SV)
Efficiency vs. Output Voltage

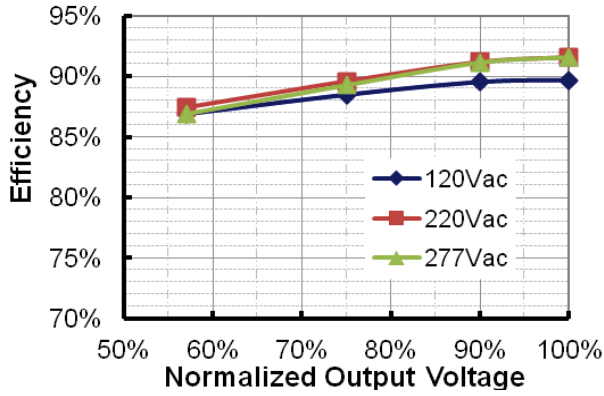

EUC-120T070DV(SV)
Efficiency vs. Output Voltage

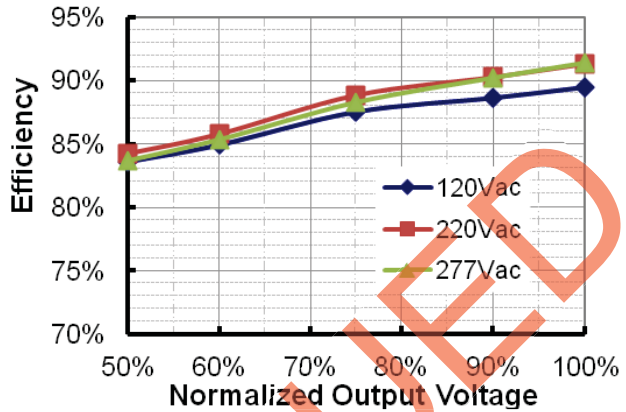

EUC-120T105DV(SV)
Efficiency vs. Output Voltage

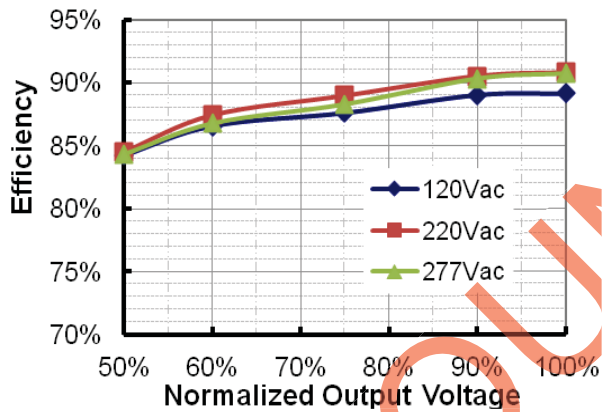

EUC-120T140DV(SV)
Efficiency vs. Output Voltage

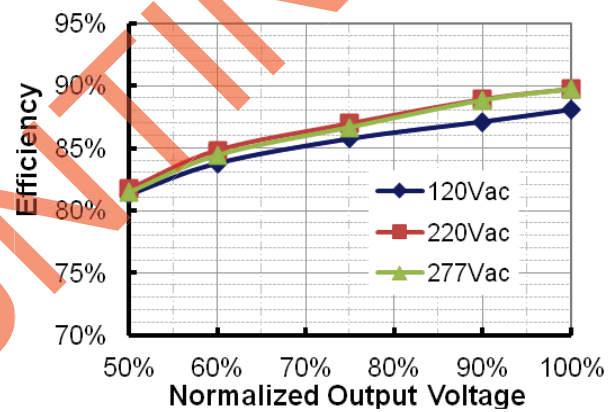

Power Factor Characteristics

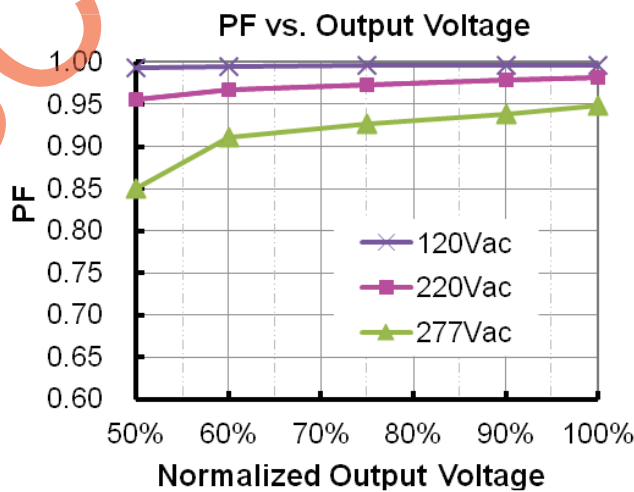

Total Harmonic Distortion

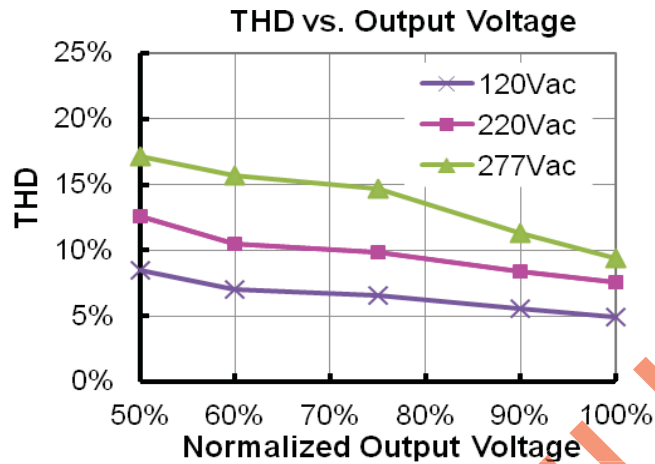

Dimming Control (On the secondary side)

Parameter	Min.	Typ.	Max.	Notes
12V output voltage	10.8 V	12 V	13.2 V	
12V output source current	0 mA	-	20 mA	
Absolute maximum voltage on the 1~10V input pin	0 V	-	12 V	
Source current on 1~10V input pin	0 uA	-	200 uA	

The dimmer control is operated from an input signal of 0(1) –10 Vdc. Recommended implementations are provided below.

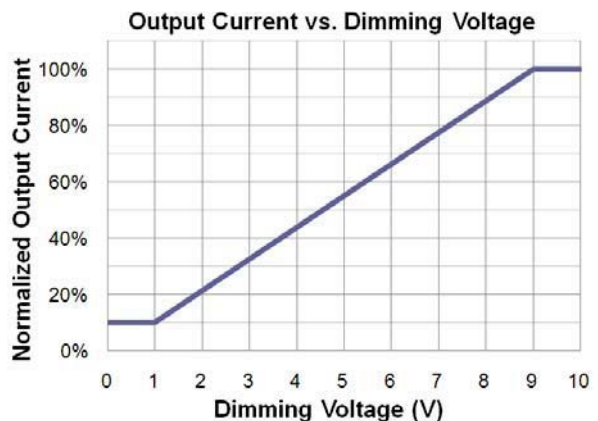
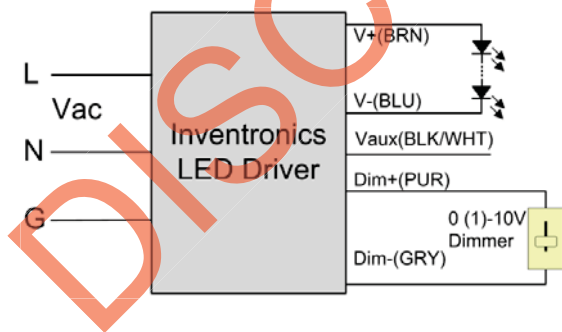

Implementation 1: DC Input

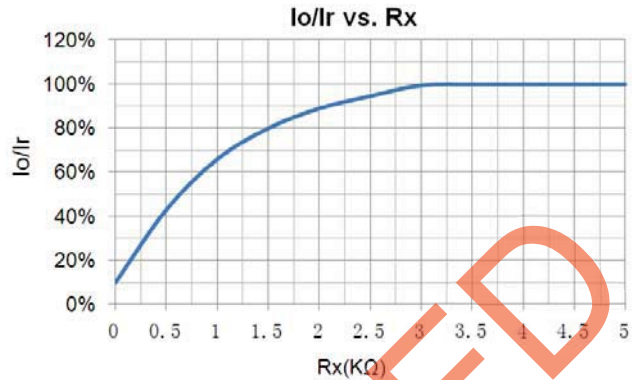
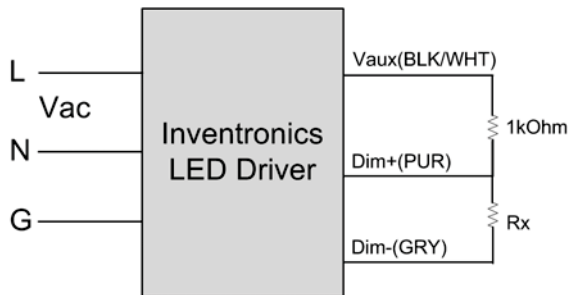

Implementation 2: External Resistor

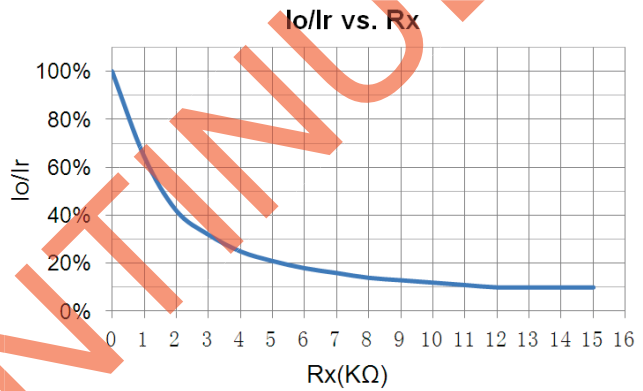
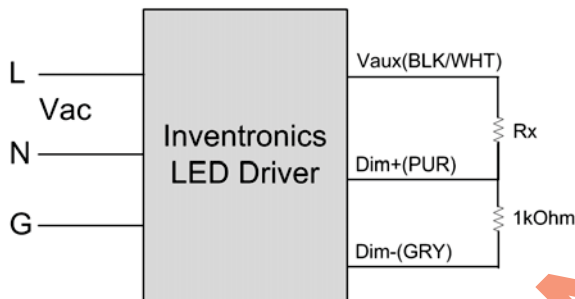

Implementation 3: External Resistor

Notes:

1. I_o is actual output current and I_r is rated current without dimming control.
2. For the driver to operate properly, the load voltage must be maintained above the minimum voltage threshold (approx. 50% of the max. output voltage for any given model).
3. If the output voltage is maintained above 50% of the maximum output voltage, the dimming control may be operated over the entire 1-10V range with output current varying from 10% to 100% of I_r .
4. The dimming signal is allowed to be less than 1V, however, when it for 0-1V, the output current is 10% I_o .
5. Do not connect the GND of dimming to the output; otherwise, the LED driver cannot work normally.
6. If 0-10V dimming is not used, Dim + can be either open or connected to Vaux.

Mechanical Outline

EUC-120TxxxDV

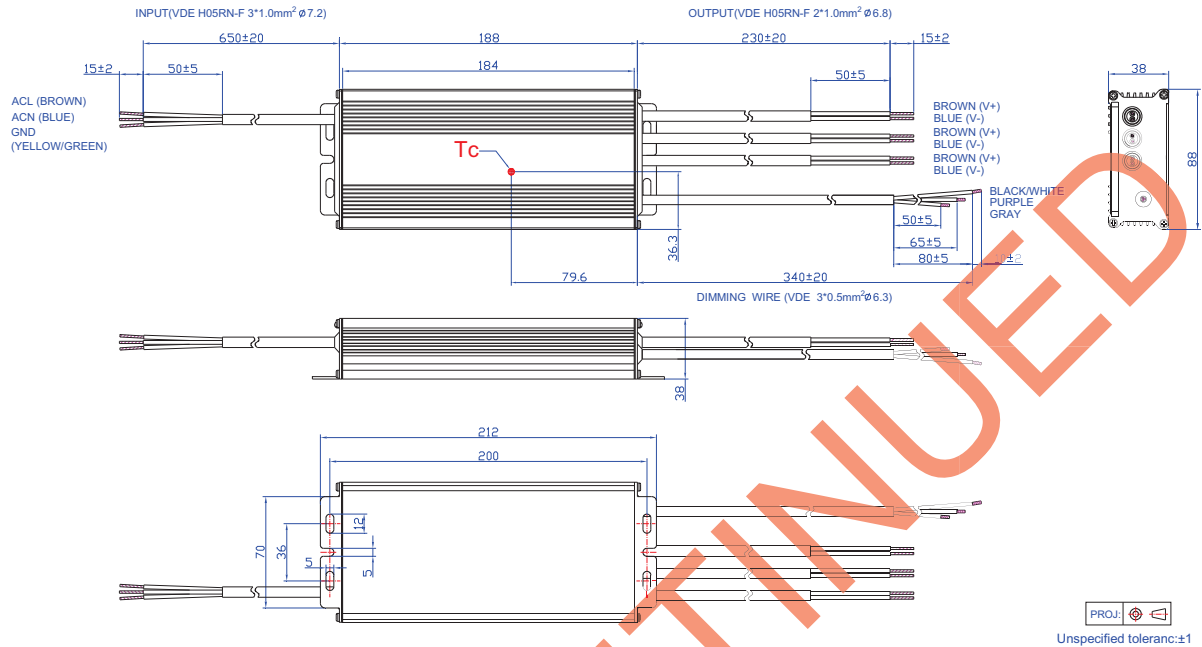

EUC-120TxxxSV

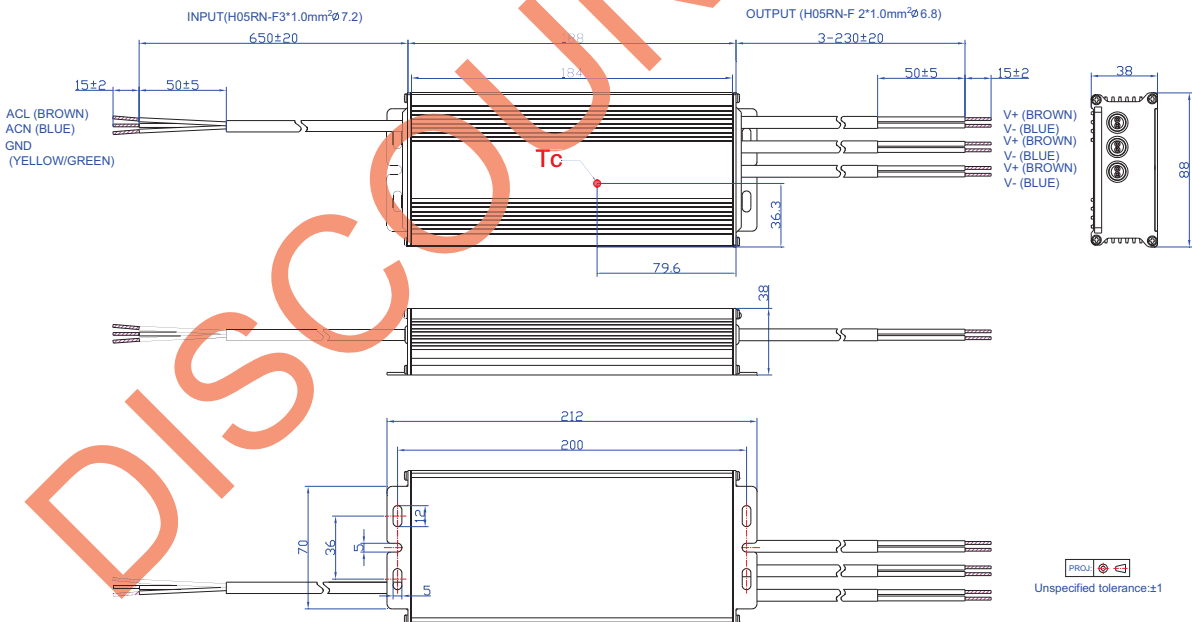

RoHS Compliance

Our products comply with reference to RoHS Directive (EU) 2015/863 amending 2011/65/EU, calling for the elimination of lead and other hazardous substances from electronic products.

Revision History

Change Date	Rev.	Description of Change		
		Item	From	To
2012-03-06	A	Datasheets Release	/	/
2012-05-02	B	450 mA Model	/	Added
		1400 mA Model	/	Added
		Output Power---600mA Updated	120W	126W
		No Load Output Voltage	/	Updated
		Efficiency, PF Curve	/	Corrected
2012-05-17	C	Max of No Load Voltage	/	Added
		Operating Temperature	-35°C	40°C
2012-05-22	D	Output Current Ripple (pk-pk) Max	30%Io	15%Io
		Inrush Current	50 A	65 A
2012-07-09	E	Derating Curve	/	Updated
2012-07-17	F	Max Case Temperature	/	Updated
2012-09-05	G	Derating Curve	/	Updated
		Life time Curve	/	Updated
		Turn-on delay time @120Vac	Type 1.0s, max 3.0s	Type 1.0s, max 2.0s
		Turn-on delay time @220Vac	Type 1.0s, max 3.0s	Type 0.5s, max 1.5s
		PF Min	/	Added
		THD Max	/	Added
		Inrush Current(I ² t)	/	Added
		Temperature co-efficient	/	Added
2013-09-09	H	Output Current Ripple	/	Updated
		Temperature Coefficient	0.02%/°C	0.03%/°C
		Over Temperature Protection-Tc point corrected	115 °C	120 °C
		Turn-on delay time @120Vac	Type 1.0s, max 2.0s	Type 2.0s, max 3.0s
		Turn-on delay time @220Vac	Type 0.5s, max 1.5s	Type 2.0s, max 3.0s
		Derating curve	/	Updated
		Life time	53,500 Hours	98,000 Hours
		Life time curve	/	Updated

Revision History (Continued)

Change Date	Rev.	Description of Change		
		Item	From	To
2013-09-09	H	Efficiency Min value of all models Model 1400mA Model 600 mA@120Vac Typical Model 1050 mA@120Vac Typical	/	1% lower 0.5% lower 89% 88.5%
		Efficiency curves of other models except 350mA	/	Added
		PF curve	/	Added
		THD curve	/	Added
		Io/Ir vs.Rx Dimming curve	/	Added
2013-10-10	I	No-load Output Voltage	/	Updated
2017-09-11	J	CCC	/	Updated
		KS	/	Added
		Features	/	Updated
		Description	/	Updated
		Models	Notes	Updated
		Input Specifications	PF/THD	Updated
		Output Specifications	Turn-on Delay Time	Updated
		Output Specifications	Temperature Coefficient	Updated
		General Specifications	Case Temperature	Operating Case Temperature for Safety Tc_s
		General Specifications	Operating Case Temperature for Warranty Tc_w	Added
		General Specifications	Storage Temperature	Added
		General Specifications	With mounting ear	Added
		Environmental Specifications	/	Deleted
		Safety & EMC Compliance	/	Updated
		Lifetime vs. Case Temperature Curve	/	Updated
Mechanical Outline	/	Updated		
2018-09-26	K	PSE/TUV	/	Updated
		Features	5 Years Warranty	Added
		Description	/	Updated
		No Load Output Voltage	/	Added
		Operating Case Temperature for Warranty Tc_w	Case temperature for 5 years warranty	Added

Revision History (Continued)

Change Date	Rev.	Description of Change		
		Item	From	To
2018-09-26	K	Safety & EMC Compliance	/	Updated
2019-12-31	L	CCC Logo	/	Deleted
		PSE Logo	/	Deleted
		Features	4kV line-line, 6kV line-earth	DM 4kV , CM 6kV
		Features	Waterproof (IP67)	IP67
		Safety & EMC Compliance	PSE	Deleted
		Safety & EMC Compliance	EN 55015/GB 17743	EN 55015 ⁽¹⁾
		Safety & EMC Compliance	EN 61000-3-2/GB 17625.1	EN 61000-3-2
		Safety & EMC Compliance	EN 61000-4-5	Updated
		Safety & EMC Compliance	Note (1)	Added
		Derating Curve	/	Deleted
		RoHS Compliance	/	Updated