

Features

- High Efficiency (Up to 92.5%)
- Constant Current Output
- 0-10V Dimming Control
- Input Surge Protection: DM 4kV, CM 6kV
- All-Around Protection: OVP, SCP, OTP
- IP67
- SELV Output



Description

The EUC-150SxxxDV(SV) series is a 150W, constant-current LED driver that operates from 90-305 Vac input with excellent power factor. It is created for many lighting applications including high bay, tunnel and roadway, etc. The high efficiency of these drivers and compact metal case enables them to run cooler, significantly improving reliability and extending product life. To ensure trouble-free operation, protection is provided against input surge, output over voltage, short circuit, and over temperature.

Models

Output Current	Input Voltage Range(1)	Output Voltage Range	Max. Output Power	Typical Efficiency (2)	Power Factor		Model Number (3,4)
					120Vac	220Vac	
350 mA	90 ~ 305 Vac	256-428 Vdc	150 W	92.5%	0.99	0.95	EUC-150S035SV
350 mA	90 ~ 305 Vac	214-428 Vdc	150 W	92.5%	0.99	0.95	EUC-150S035DV
450 mA	90 ~ 305 Vac	200-333 Vdc	150 W	92.5%	0.99	0.95	EUC-150S045SV
450 mA	90 ~ 305 Vac	166-333 Vdc	150 W	92.5%	0.99	0.95	EUC-150S045DV
700 mA	90 ~ 305 Vac	128-214 Vdc	150 W	92.5%	0.99	0.95	EUC-150S070SV
700 mA	90 ~ 305 Vac	107-214 Vdc	150 W	92.5%	0.99	0.95	EUC-150S070DV
1050 mA	90 ~ 305 Vac	85-142 Vdc	150 W	92.0%	0.99	0.95	EUC-150S105SV
1050 mA	90 ~ 305 Vac	71-142 Vdc	150 W	92.0%	0.99	0.95	EUC-150S105DV
1400 mA	90 ~ 305 Vac	64-107 Vdc	150 W	92.0%	0.99	0.95	EUC-150S140SV ⁽⁵⁾
1400 mA	90 ~ 305 Vac	53-107 Vdc	150 W	92.0%	0.99	0.95	EUC-150S140DV ⁽⁵⁾
1750 mA	90 ~ 305 Vac	51-85 Vdc	150 W	91.5%	0.99	0.95	EUC-150S175SV ⁽⁵⁾
2100 mA	90 ~ 305 Vac	42-71 Vdc	150 W	91.5%	0.99	0.95	EUC-150S210SV ⁽⁵⁾
2450 mA	90 ~ 305 Vac	36-61 Vdc	150 W	91.5%	0.99	0.95	EUC-150S245SV ⁽⁵⁾
2800 mA	90 ~ 305 Vac	31-53 Vdc	150 W	91.5%	0.99	0.95	EUC-150S280SV ⁽⁵⁾
3150 mA	90 ~ 305 Vac	28-47 Vdc	150 W	91.5%	0.99	0.95	EUC-150S315SV ⁽⁵⁾
3500 mA	90 ~ 305 Vac	25-42 Vdc	150 W	91.5%	0.99	0.95	EUC-150S350SV ⁽⁵⁾

Models (Continued)

Output Current	Input Voltage Range(1)	Output Voltage Range	Max. Output Power	Typical Efficiency (2)	Power Factor		Model Number (3,4)
					120Vac	220Vac	
4200 mA	90 ~ 305 Vac	21-35 Vdc	150 W	91.5%	0.99	0.95	EUC-150S420SV ⁽⁵⁾
4900 mA	90 ~ 305 Vac	18-30 Vdc	150 W	90.0%	0.99	0.95	EUC-150S490SV ⁽⁵⁾
5950 mA	90 ~ 305 Vac	15-25 Vdc	150 W	90.0%	0.99	0.95	EUC-150S595SV ⁽⁵⁾

Notes: (1) Certified input Voltage range 100-240Vac.

(2) Measured at 100% load and 220 Vac input.

(3) All the models are certificated to CE, except EUC-150SxxxSV are also certificated to CB.

(4) All the models are certificated to KS, except EUC-150S035DV/SV and EUC-150S045DV/SV.

(5) SELV output.

Input Specifications

Parameter	Min.	Typ.	Max.	Notes
Input Voltage	90 Vac	-	305 Vac	
Input Frequency	47 Hz	-	63 Hz	
Leakage Current	-	-	0.75 mA	At 240Vac/60Hz input, grounding effectively
Input AC Current	-	-	1.98 A	Measured at 100%load and 100 Vac input.
	-	-	0.95 A	Measured at 100%load and 220 Vac input.
Inrush Current(I ² t)	-	-	7.5 A ² s	At 220Vac input, 25°C cold start, duration=2.5 ms, 10%Ipk-10%Ipk.
PF	0.9	-	-	At 100-240 Vac, 100% Load
THD	-	-	20%	

Output Specifications

Parameter	Min.	Typ.	Max.	Notes
Output Current Tolerance	-5%lo	-	5%lo	At 100%load condition.
Total Output Current Ripple (pk-pk)	-	10%lo	15%lo	At 100%load condition, 20 MHz BW
Output Current Ripple at < 200 Hz (pk-pk)	-	2%lo	-	At 100%load condition. Only this component of ripple is associated with visible flicker.
Startup Overshoot Current	-	-	10%lo	At 100%load condition.

Output Specifications (Continued)

Parameter	Min.	Typ.	Max.	Notes
No load Output Voltage				
$I_o = 350$ mA	-	-	465 V	
$I_o = 450$ mA	-	-	365 V	
$I_o = 700$ mA	-	-	232 V	
$I_o = 1050$ mA	-	-	155 V	
$I_o = 1400$ mA	-	-	116 V	
$I_o = 1750$ mA	-	-	93 V	
$I_o = 2100$ mA	-	-	78 V	
$I_o = 2450$ mA	-	-	67 V	
$I_o = 2800$ mA	-	-	58 V	
$I_o = 3150$ mA	-	-	51 V	
$I_o = 3500$ mA	-	-	46 V	
$I_o = 4200$ mA	-	-	39 V	
$I_o = 4900$ mA	-	-	33 V	
$I_o = 5950$ mA	-	-	28 V	
Line Regulation	-	-	$\pm 1\%$	At 100%load condition.
Load Regulation	-	-	$\pm 3\%$	
Turn-on Delay Time	-	1.5 s	3.0 s	Measured at 120Vac input.
	-	1.0 s	2.0 s	Measured at 220Vac input.
Temperature Coefficient	-	0.03%/°C	-	Case temperature = 0°C ~Tc max

General Specifications

Parameter	Min.	Typ.	Max.	Notes
Efficiency at 120 Vac input:				
$I_o = 350$ mA	89.5%	90.5%	-	Measured at 100%load and steady-state temperature in 25°C ambient; (Efficiency will be about 1.0% lower if measured immediately after startup.)
$I_o = 450$ mA	89.5%	90.5%	-	
$I_o = 700$ mA	89.5%	90.5%	-	
$I_o = 1050$ mA	89.0%	90.0%	-	
$I_o = 1400$ mA	89.0%	90.0%	-	
$I_o = 1750$ mA	88.0%	90.0%	-	
$I_o = 2100$ mA	88.0%	90.0%	-	
$I_o = 2450$ mA	87.5%	89.5%	-	
$I_o = 2800$ mA	87.5%	89.5%	-	
$I_o = 3150$ mA	87.0%	89.0%	-	
$I_o = 3500$ mA	87.0%	89.0%	-	
$I_o = 4200$ mA	86.5%	88.5%	-	
$I_o = 4900$ mA	86.5%	88.5%	-	
$I_o = 5950$ mA	86.5%	88.5%	-	
Efficiency at 220 Vac input:				
$I_o = 350$ mA	91.5%	92.5%	-	Measured at 100%load and steady-state temperature in 25°C ambient; (Efficiency will be about 1.0% lower if measured immediately after startup.)
$I_o = 450$ mA	91.5%	92.5%	-	
$I_o = 700$ mA	91.5%	92.5%	-	
$I_o = 1050$ mA	91.0%	92.0%	-	
$I_o = 1400$ mA	91.0%	92.0%	-	
$I_o = 1750$ mA	89.5%	91.5%	-	
$I_o = 2100$ mA	89.5%	91.5%	-	
$I_o = 2450$ mA	89.5%	91.5%	-	
$I_o = 2800$ mA	89.5%	91.5%	-	
$I_o = 3150$ mA	89.5%	91.5%	-	
$I_o = 3500$ mA	89.5%	91.5%	-	
$I_o = 4200$ mA	89.5%	91.5%	-	
$I_o = 4900$ mA	88.0%	90.0%	-	
$I_o = 5950$ mA	88.0%	90.0%	-	

General Specifications (Continued)

Parameter	Min.	Typ.	Max.	Notes
Efficiency at 277 Vac input: <i>I</i> _o = 350 mA <i>I</i> _o = 450 mA <i>I</i> _o = 700 mA <i>I</i> _o = 1050 mA <i>I</i> _o = 1400 mA <i>I</i> _o = 1750 mA <i>I</i> _o = 2100 mA <i>I</i> _o = 2450 mA <i>I</i> _o = 2800 mA <i>I</i> _o = 3150 mA <i>I</i> _o = 3500 mA <i>I</i> _o = 4200 mA <i>I</i> _o = 4900 mA <i>I</i> _o = 5950 mA	91.5% 91.5% 91.5% 91.0% 91.0% 89.5% 89.5% 89.5% 89.5% 89.5% 89.5% 89.5% 88.0% 88.0%	92.5% 92.5% 92.5% 92.0% 92.0% 91.5% 91.5% 91.5% 91.5% 91.5% 91.5% 91.5% 90.0% 90.0%	- - - - - - - - - - - - - -	Measured at 100%load and steady-state temperature in 25°C ambient; (Efficiency will be about 1.0% lower if measured immediately after startup.)
MTBF	-	370,000 Hours	-	Measured at 120Vac input, 80%Load and 25°C ambient temperature (MIL-HDBK-217F)
Lifetime	-	85,000 Hours	-	Measured at 220Vac input, 80%Load and 60°C case temperature; See life time vs. Tc curve for the details
Operating Case Temperature for Safety Tc _s	-35 °C	-	+90°C	
Operating Case Temperature for Warranty Tc _w	-35 °C	-	+65 °C	
Storage Temperature	-40 °C	-	+85 °C	Humidity: 5% RH to 100% RH
Dimensions Inches (L x W x H) Millimeters (L x W x H)	9.41 x 3.13 x 1.81 239 x 79.5 x 46			With mounting ear 10.47 x 3.13 x 1.81 266 x 79.5 x 46
Net Weight	-	1500 g	-	

Safety & EMC Compliance

Safety Category	Standard
CE	EN 61347-1, EN 61347-2-13
CB	IEC 61347-1, IEC 61347-2-13
KS	KS C 7655
EMI Standards	Notes
EN 55015 ⁽¹⁾	Conducted emission Test & Radiated emission Test
EN 61000-3-2	Harmonic current emissions
EN 61000-3-3	Voltage fluctuations & flicker
EMS Standards	Notes
EN 61000-4-2	Electrostatic Discharge (ESD): 8 kV air discharge, 4 kV contact discharge
EN 61000-4-3	Radio-Frequency Electromagnetic Field Susceptibility Test-RS
EN 61000-4-4	Electrical Fast Transient / Burst-EFT

Safety & EMC Compliance (Continued)

EMS Standards	Notes
EN 61000-4-5	Surge Immunity Test: AC Power Line: Differential Mode 4 kV, Common Mode 6 kV ⁽²⁾
EN 61000-4-6	Conducted Radio Frequency Disturbances Test-CS
EN 61000-4-8	Power Frequency Magnetic Field Test
EN 61000-4-11	Voltage Dips
EN 61547	Electromagnetic Immunity Requirements Applies To Lighting Equipment

Note: (1) This LED driver meets the EMI specifications above, but EMI performance of a luminaire that contains it depends also on the other devices connected to the driver and on the fixture itself.
 (2) To perform electric strength (hi-pot) testing, the “GDT ground disconnect” (nut and metal lock sheet) on the driver end-cap should be removed temporarily to prevent the internal gas discharge tube from conducting (as allowed by IEC 60598-1 Clause 10.2). After testing is completed, these items must be reinstalled to restore line-to-earth surge protection and secure the end cap.

Lifetime vs. Case Temperature Curve

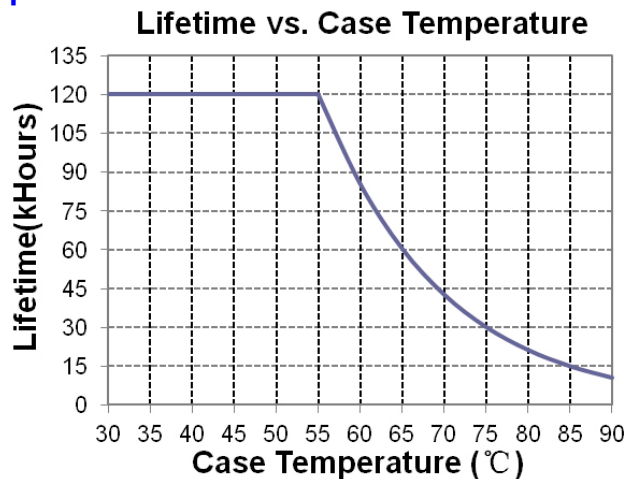

Efficiency vs. Load

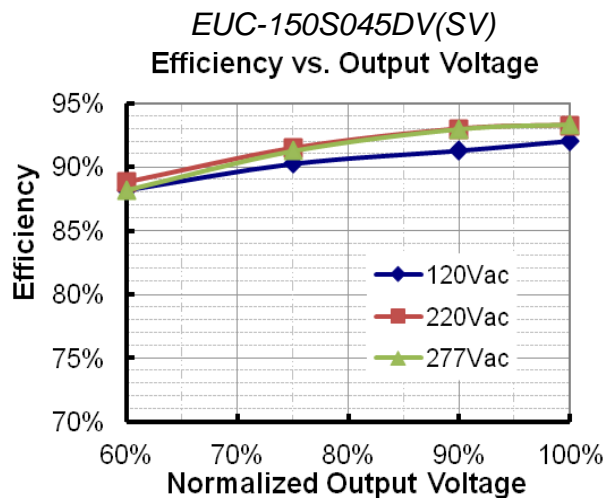
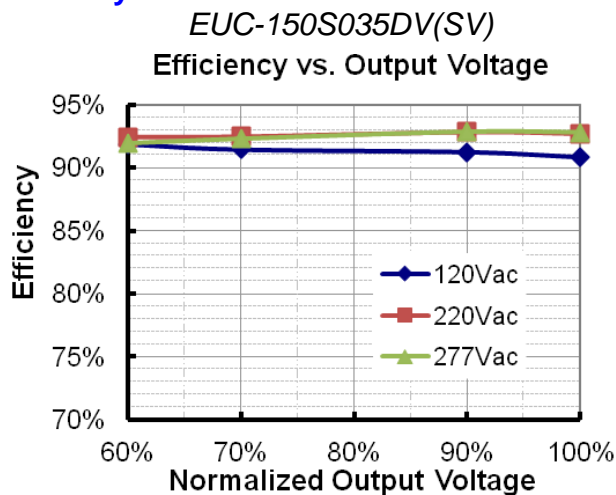

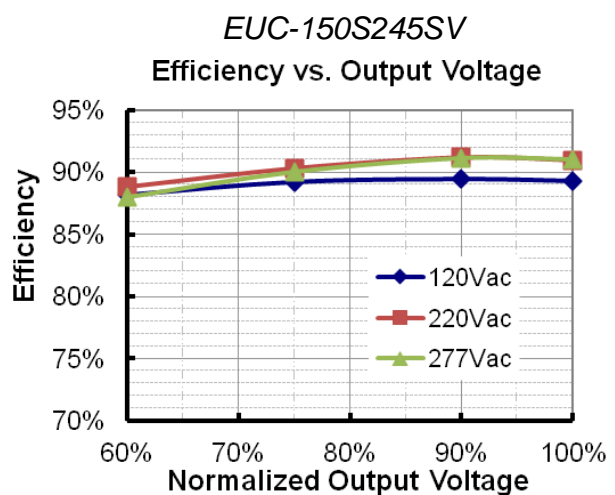
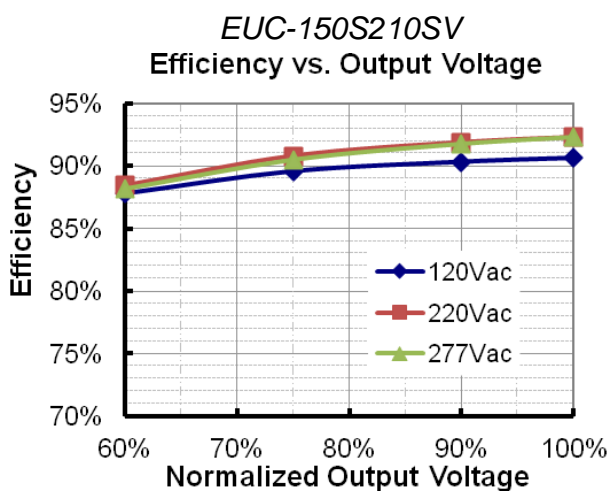
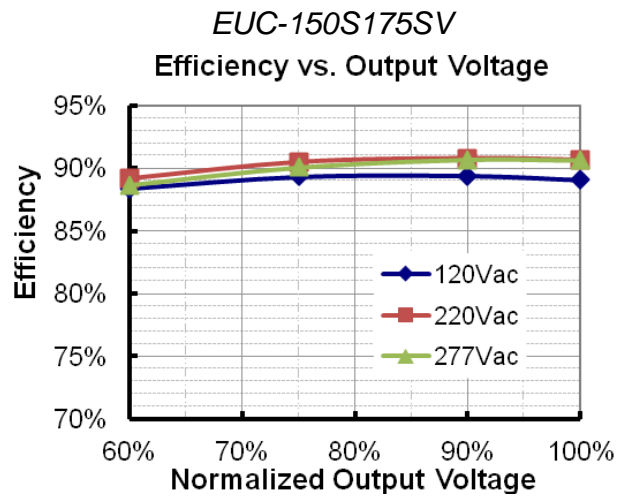
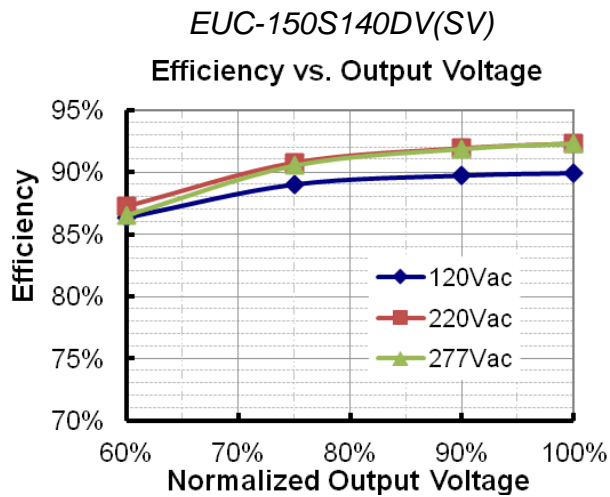
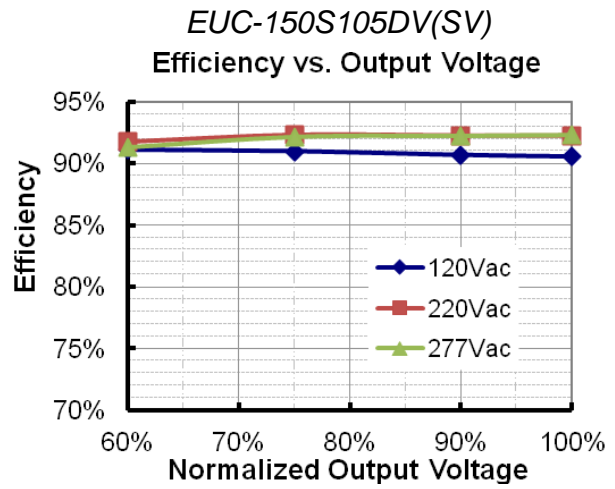
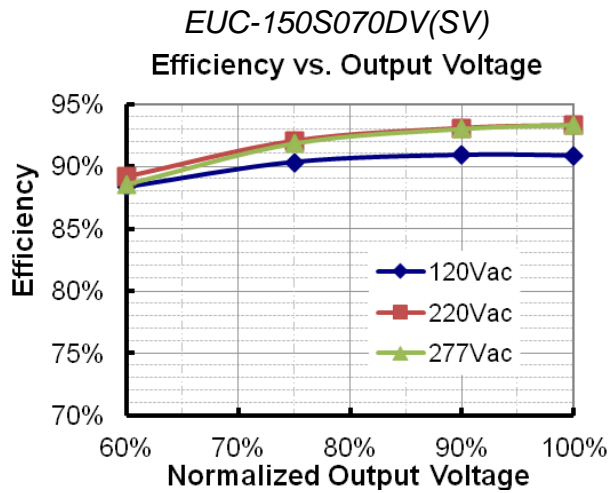

EUC-150S280SV

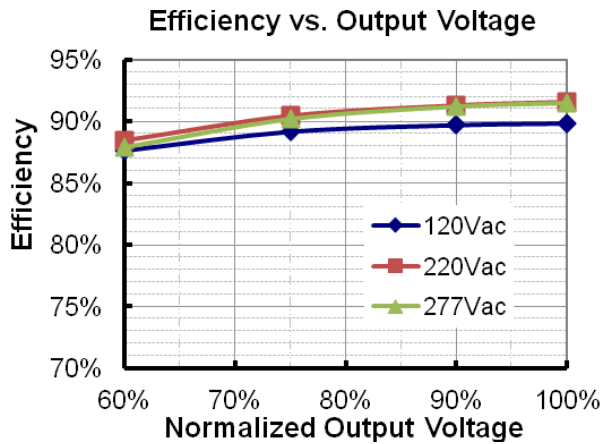

EUC-150S315SV

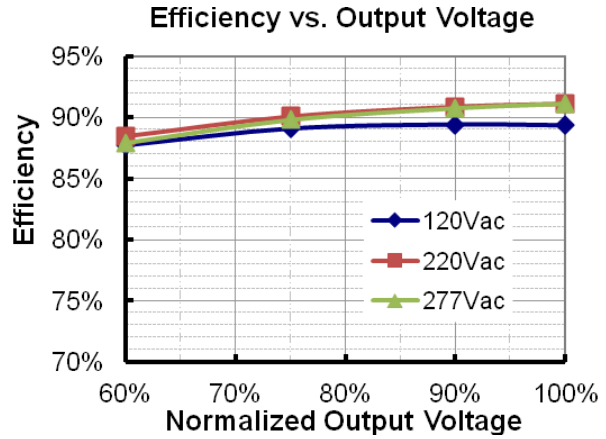

EUC-150S350SV

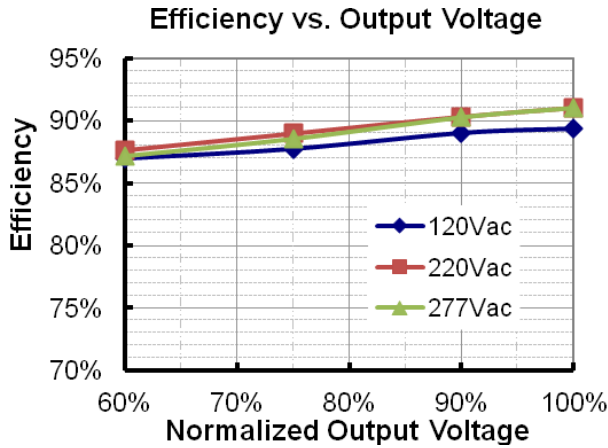

EUC-150S420SV

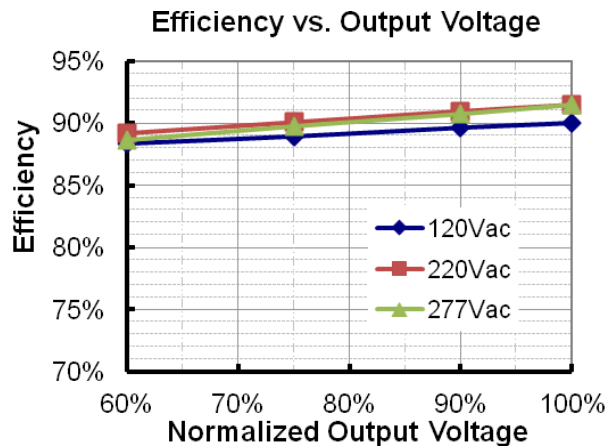

EUC-150S490SV

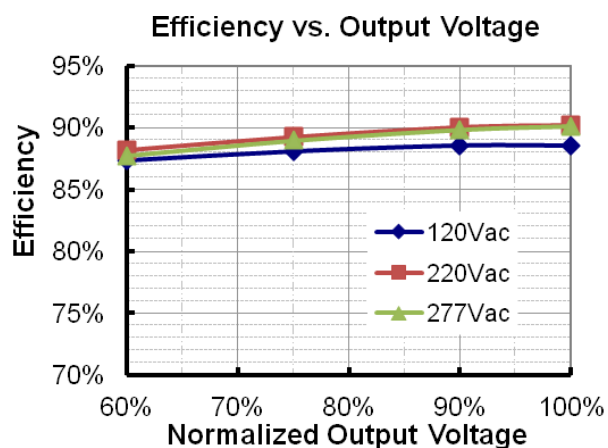

EUC-150S595SV

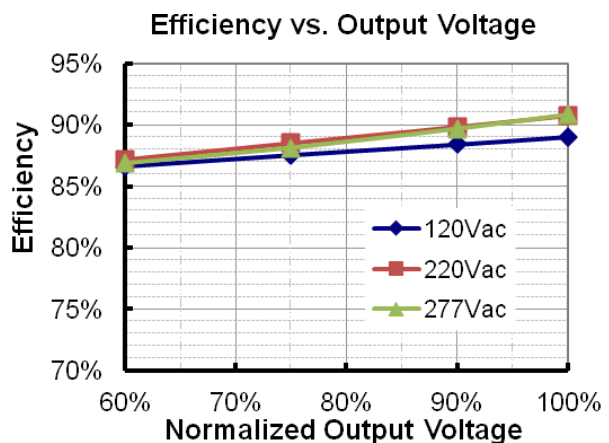

Power Factor Characteristics

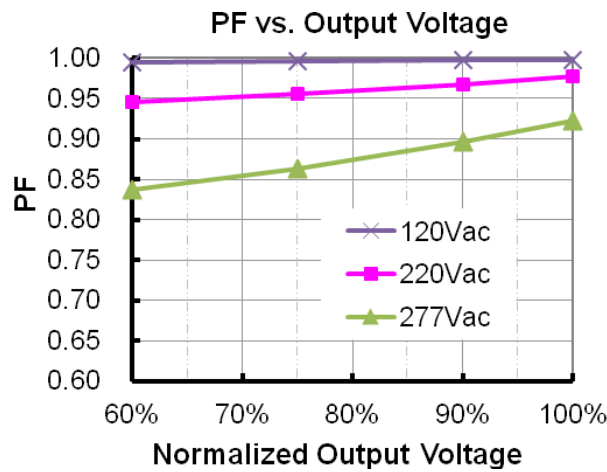

Total Harmonic Distortion

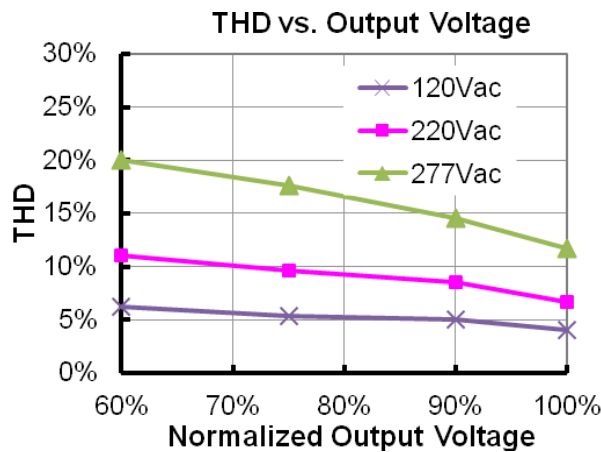

Protection Functions

Parameter	Notes
Over Temperature Protection	Auto Recovery, returning to normal after over temperature is removed.
Short Circuit Protection	No damage shall occur when any output operating in a short circuit condition. The power supply shall be self-recovery when the fault condition is removed.
Over Voltage Protection	Limits output voltage at no load and in case the normal voltage limit fails.

Dimming Control (On secondary side)

Parameter	Min.	Typ.	Max.	Notes
Absolute maximum voltage on the 1~10V input pin	-2 V	-	12 V	
Source current on 1~10V input pin	140 uA	-	220 uA	

The dimmer control may be operated from either a potentiometer or from an input signal of 1 – 10 Vdc. Two recommended implementations are provided below.

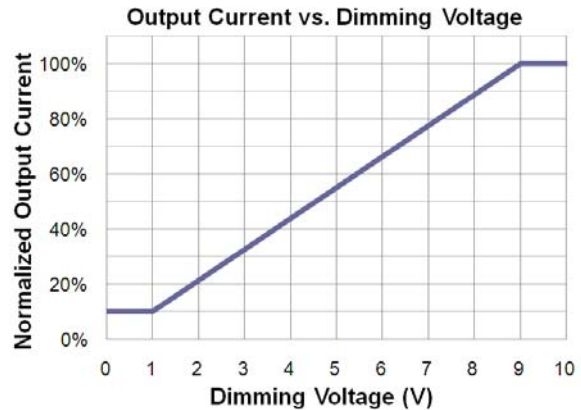
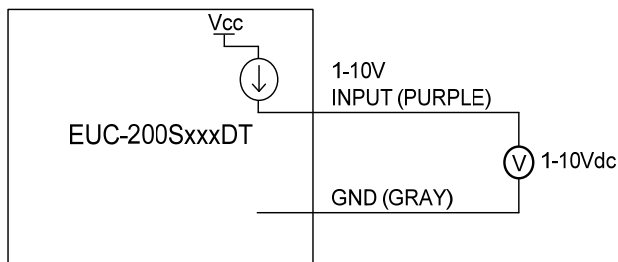

Implementation 1: DC input

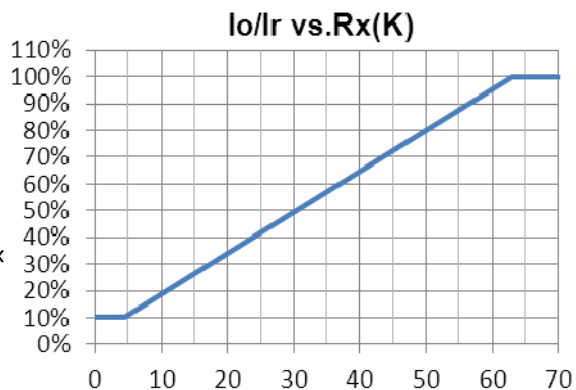
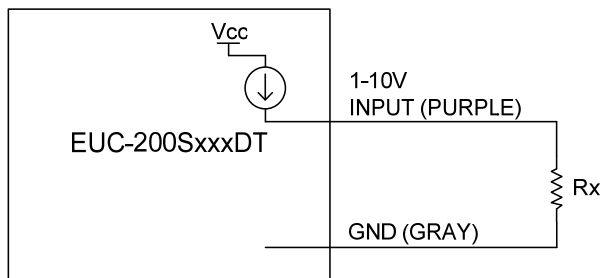

Implementation 2: External resistor

Notes:

1. I_o is actual output current and I_r is rated current without dimming control.
2. For the driver to operate properly, the load voltage must be maintained above the minimum voltage threshold (approx. 50% of the max. output voltage for any given model).
3. If the output voltage is maintained above 50% of the maximum output voltage, the dimming control may be operated over the entire 1-10V range with output current varying from 100% down to practically 10%.
4. The dimming signal is allowed to be less than 1V, however, when it for 0-1V, the output current is 10% I_o .
5. Do not connect the GND of dimming to the output; otherwise, the LED driver cannot work normally.

Mechanical Outline

EUC-150SxxxDV

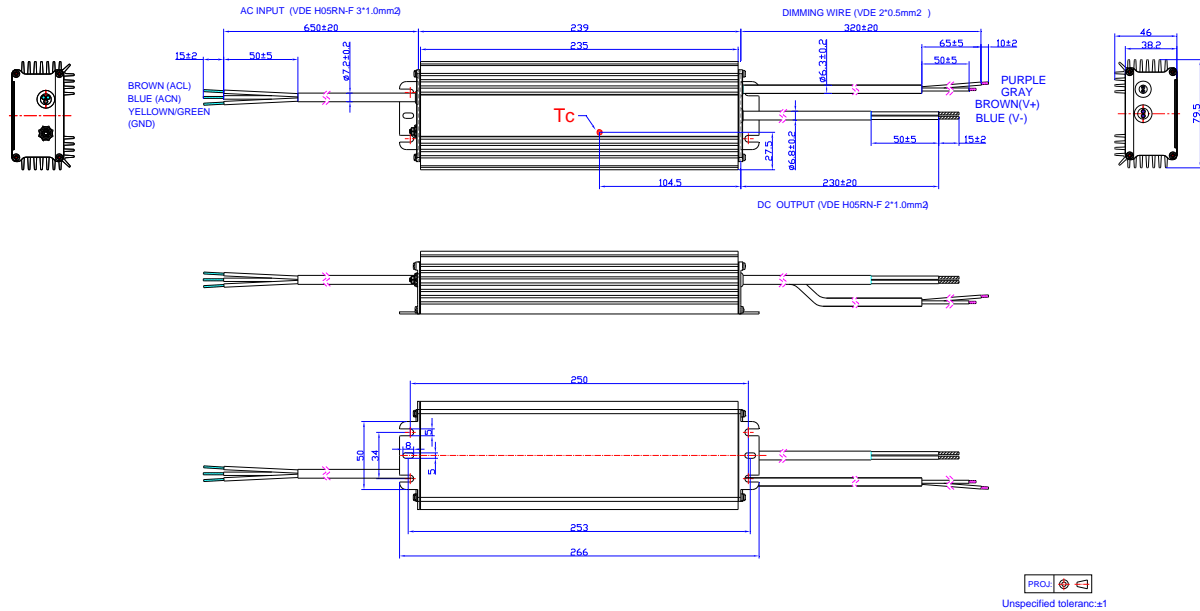

EUC-150SxxxSV

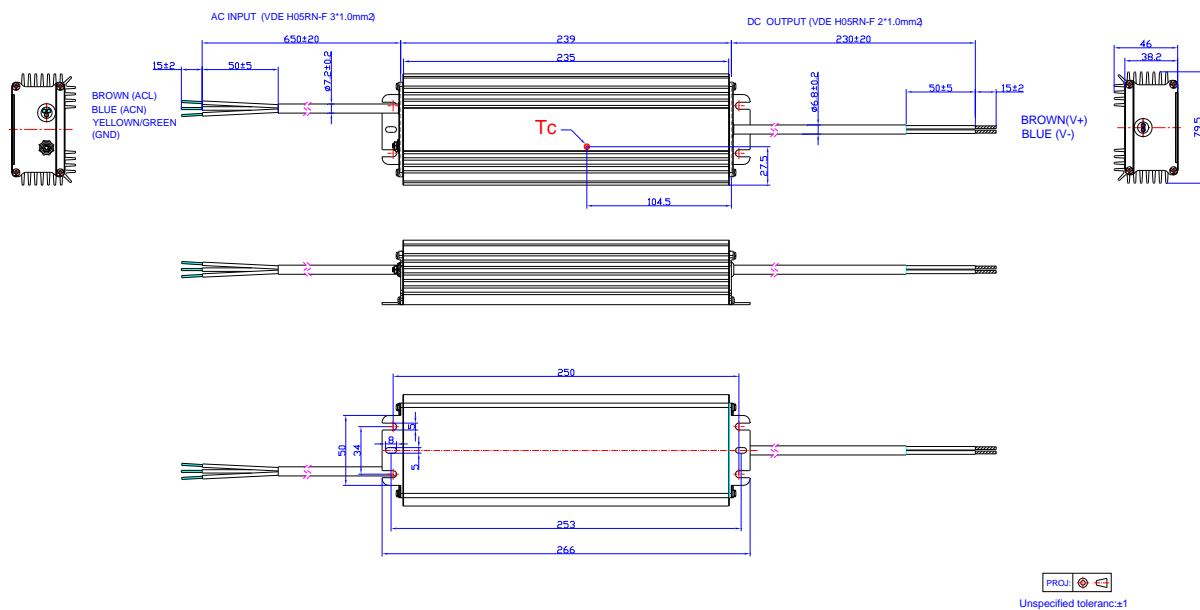

RoHS Compliance

Our products comply with reference to RoHS Directive (EU) 2015/863 amending 2011/65/EU, calling for the elimination of lead and other hazardous substances from electronic products.

Revision History

Change Date	Rev.	Description of Change		
		Item	From	To
2013-11-22	A	Datasheets Release	/	/
2015-09-10	B	Format	/	Updated
		External Grounding Screw Solution	/	/
		Features	/	Updated
		Description		Updated
		Models	Notes	Update
		Output Specifications	Output Current Ripple at < 200 Hz (pk-pk)	Added
		Output Specifications	Startup Overshoot Current	Added
		Output Specifications	No load Output Voltage	Added
		General Specifications	Case Temperature	Operating Case Temperature for Safety Tc_s
		General Specifications	Operating Case Temperature for Warranty Tc_w	Added
		General Specifications	Storage Temperature	Added
		Environmental Specifications	/	Delete
		Safety & EMC Compliance		Updated
		Protection Functions		Updated
Dimming Control		Updated		
Mechanical Outline		Updated		
2016-04-07	C	KS	/	Added
		Models	/	Updated
		General Specifications	With mounting ear	Added
		Safety & EMC Compliance	/	Updated
2016-11-10	D	PSE	/	Delete
		Mechanical Outline	/	Updated
2019-08-20	E	TUV	/	Deleted
		Models	Notes(3)	Updated
		Safety & EMC Compliance	KS	Updated
2020-01-19	F	Independent Logo	/	Added
		Features	4kV line-line, 6kV line-earth	DM 4kV, CM 6kV
		Features	Waterproof (IP67)	IP67

Revision History (Continued)

Change Date	Rev.	Description of Change		
		Item	From	To
2020-01-19	F	Features	Suitable for Independent Use	Deleted
		Description	Application environment	Updated
		Safety &EMC Compliance	CB	Added
		Safety &EMC Compliance	EN 61000-4-5	Updated
		Derating Curve	/	Deleted
		RoHS Compliance	/	Updated
		Format	Page footer	Updated