

Features

- Ultra High Efficiency (Up to 94%)
- Constant Current Output
- 0-10V Dimmable
- Dim-to-Off with Standby Power ≤ 1.5 W
- Input surge protection: DM 4kV, CM 6kV
- All-Around Protection: OVP, SCP, OTP
- IP67
- SELV Output
- Suitable for EU Independent Use



Description

The EUC-320SxxxDV(SV) series is a 320W, constant-current LED driver that operates from 90-305 Vac input with excellent power factor. Created for high bay, high mast, arena and roadway lights, it provides a dim-to-off mode with low standby power. The high efficiency of these drivers and compact metal case enables them to run cooler, significantly improving reliability and extending product life. To ensure trouble-free operation, protection is provided against input surge, output over voltage, short circuit, and over temperature.

Models

Output Current	Input Voltage Range(1)	Output Voltage Range	Max. Output Power	Typical Efficiency (2)	Typical Power Factor		Model Number (3)
					120Vac	220Vac	
1050 mA	90 ~ 305 Vac 127~250 Vdc	152~304Vdc	320 W	94.0%	0.99	0.96	EUC-320S105DV(SV)
1400 mA	90 ~ 305 Vac 127~250 Vdc	114~228Vdc	320 W	94.0%	0.99	0.96	EUC-320S140DV(SV)
2100 mA	90 ~ 305 Vac 127~250 Vdc	76~152 Vdc	320 W	94.0%	0.99	0.96	EUC-320S210DV(SV)
2800 mA	90 ~ 305 Vac 127~250 Vdc	57~111 Vdc	310 W	93.0%	0.99	0.96	EUC-320S280DV(SV) ⁽⁵⁾
4900 mA	90 ~ 305 Vac 127~250 Vdc	33 ~65 Vdc	320 W	93.0%	0.99	0.96	EUC-320S490DV(SV) ⁽⁴⁾⁽⁵⁾
6200 mA	90 ~ 305 Vac 127~250 Vdc	26 ~52 Vdc	320 W	93.0%	0.99	0.96	EUC-320S620DV(SV) ⁽⁴⁾⁽⁵⁾

- Notes:** (1) Certified input voltage range: 100-240Vac /127-250Vdc
 (2) Measured at 100% load and 220 Vac input.
 (3) All the models are certificated to BIS, except EUC-320S105DV and EUC-320S280DV
 (4) EUC-320S490/620DV/SV are certificated to KC, KCC
 (5) SELV Output

Input Specifications

Parameter	Min.	Typ.	Max.	Notes
Input AC Voltage	90 Vac	-	305 Vac	
Input DC Voltage	127 Vdc	-	250 Vdc	
Input Frequency	47 Hz	-	63 Hz	

Input Specifications (Continued)

Parameter	Min.	Typ.	Max.	Notes
Leakage Current	-	-	0.70 mA	IEC60598-1; 240Vac/ 60Hz , grounding effectively
Input AC Current	-	-	4.0 A	Measured at 100% load and 100Vac input.
	-	-	2.0 A	Measured at 100% load and 220Vac input.
Inrush Current(I ² t)	-	-	3.5 A ² s	At 220Vac input 25°C cold start, duration=4mS, 10%I _{pk} -10%I _{pk} . See Inrush Current Waveform for the details.
PF	0.90	-	-	At 100-277Vac, 50-60Hz, 75%load-100%load (240-320W)
THD	-	-	20%	

Output Specifications

Parameter	Min.	Typ.	Max.	Notes
Output Current Tolerance	-5%I _o	-	5%I _o	At 100% load condition
Total Output Current Ripple (pk-pk)	-	5%I _o	10%I _o	At 100% load condition, 20 MHz BW
Output Current Ripple at < 200 Hz (pk-pk)	-	2%I _o	-	At 100% load condition. Only this component of ripple is associated with visible flicker.
Startup Overshoot Current	-	-	10%I _o	At 100% load condition.
No load Output Voltage				
I _o = 1050 mA	-	-	340 V	
I _o = 1400 mA	-	-	260 V	
I _o = 2100 mA	-	-	170 V	
I _o = 2800 mA	-	-	120 V	
I _o = 4900 mA	-	-	74 V	
I _o = 6200 mA	-	-	58 V	
Line Regulation	-	-	±0.5%	Measured at 100% load
Load Regulation	-	-	±1.5%	
Turn-on Delay Time	-	0.5 s	1.0 s	Measured at 120V and 220Vac input.
Temperature Coefficient of I _o	-	0.03%/°C	-	Case temperature = 0°C ~T _c max
12V Auxiliary Output Voltage	10.8 V	12 V	13.2 V	
12V Auxiliary Output Source Current	0 mA	-	200 mA	Return terminal is "Dim"

General Specifications

Parameter	Min.	Typ.	Max.	Notes
Efficiency at 120 Vac input: I _o = 1050 mA I _o = 1400 mA I _o = 2100 mA I _o = 2800 mA I _o = 4900 mA I _o = 6200 mA	90.0% 90.0% 89.5% 89.0% 88.5% 88.5%	92.0% 92.0% 91.5% 91.0% 90.5% 90.5%	- - - - - -	Measured at 100% load and steady-state temperature in 25°C ambient; (Efficiency will be about 2.0% lower if measured immediately after startup.)
Efficiency at 220 Vac input: I _o = 1050 mA I _o = 1400 mA I _o = 2100 mA I _o = 2800 mA I _o = 4900 mA I _o = 6200 mA	92.0% 92.0% 92.0% 91.0% 91.0% 91.0%	94.0% 94.0% 94.0% 93.0% 93.0% 93.0%	- - - - - -	Measured at 100% load and steady-state temperature in 25°C ambient; (Efficiency will be about 2.0% lower if measured immediately after startup.)
Efficiency at 277 Vac input: I _o = 1050 mA I _o = 1400 mA I _o = 2100 mA I _o = 2800 mA I _o = 4900 mA I _o = 6200 mA	92.0% 92.0% 92.0% 92.0% 91.5% 91.5%	94.0% 94.0% 94.0% 94.0% 93.5% 93.5%	- - - - - -	Measured at 100% load and steady-state temperature in 25°C ambient; (Efficiency will be about 2.0% lower if measured immediately after startup.)
Standby power	-	-	1.5 W	Measured at 230Vac/50Hz; Dimming off
MTBF	-	202,000 Hours	-	Measured at 220Vac input, 80%Load and 25°C ambient temperature (MIL-HDBK-217F)
Lifetime	-	103,000 Hours	-	Measured at 220Vac input, 80%Load and 60°C case temperature; See lifetime vs. T _c curve for the details
Operating Case Temperature for Safety T _{c_s}	-40°C	-	+90°C	
Operating Case Temperature for Warranty T _{c_w}	-40°C	-	+70°C	Humidity: 10%RH to 95%RH
Storage Temperature	-40°C	-	+85°C	Humidity: 5%RH to 95%RH
Dimensions Inches (L × W × H) Millimeters (L × W × H)	8.82 × 3.86 × 1.76 224 × 98 × 44.8			With mounting ear 9.88 × 3.86 × 1.76 251 × 98 × 44.8
Net Weight	-	1600 g	-	

Dimming Specifications

Parameter	Min.	Typ.	Max.	Notes
Absolute Maximum Voltage on the V _{dim} (+) Pin	-20 V	-	20 V	
Source Current on V _{dim} (+)Pin	100 uA	140 uA	180 uA	
Dimming Output Range	10%I _o	-	100%I _o	
Recommended Dimming Input Range	0 V	-	10 V	
Dim off Voltage	0.2 V	0.4 V	0.6 V	

Dimming Specifications (Continued)

Parameter	Min.	Typ.	Max.	Notes
Dim on Voltage	0.4 V	0.6 V	0.8 V	
Hysteresis	-	0.2 V	-	

Safety & EMC Compliance

Safety Category	Standard
ENEC & TUV & CE ⁽¹⁾	EN 61347-1, EN 61347-2-13
CB	IEC 61347-1, IEC 61347-2-13
CCC	GB 19510.1, GB 19510.14
PSE	J 61347-1, J 61347-2-13
BIS	IS 15885(Part2/Sec13)
Global Mark	AS/NZS 61347.1, AS/NZS 61347.2.13
KC	K 61347-1, K 61347-2-13
EMI Standards	Notes
EN 55015/GB 17743/KN 15 ⁽²⁾	Conducted emission Test & Radiated emission Test
EN 61000-3-2	Harmonic current emissions
EN 61000-3-3	Voltage fluctuations & flicker
EMS Standards	Notes
EN 61000-4-2	Electrostatic Discharge (ESD): 8 kV air discharge, 4 kV contact discharge
EN 61000-4-3	Radio-Frequency Electromagnetic Field Susceptibility Test-RS
EN 61000-4-4	Electrical Fast Transient / Burst-EFT
EN 61000-4-5	Surge Immunity Test: AC Power Line: Differential Mode 4 kV, Common Mode 6 kV ⁽³⁾
EN 61000-4-6	Conducted Radio Frequency Disturbances Test-CS
EN 61000-4-8	Power Frequency Magnetic Field Test
EN 61000-4-11	Voltage Dips
EN 61547	Electromagnetic Immunity Requirements Applies To Lighting Equipment

Note: (1) For compliance with EU Directive 2009/125/EC (ecodesign requirements for energy-related products) the Dim-to-Off function shall not be used or alternatively be interrupted through use of a relay or similar device to prevent excessive standby power consumption (as illustrated in Implementation 4).

(2) This LED driver meets the EMI specifications above, but EMI performance of a luminaire that contains it depends also on the other devices connected to the driver and on the fixture itself.

(3) To perform electric strength (hi-pot) testing, the "GDT ground disconnect" (nut and metal lock sheet) on the driver end-cap should be removed temporarily to prevent the internal gas discharge tube from conducting (as allowed by IEC 60598-1 Clause 10.2). After testing is completed, these items must be reinstalled to restore line-to-earth surge protection and secure the end cap.

Lifetime vs. Case Temperature

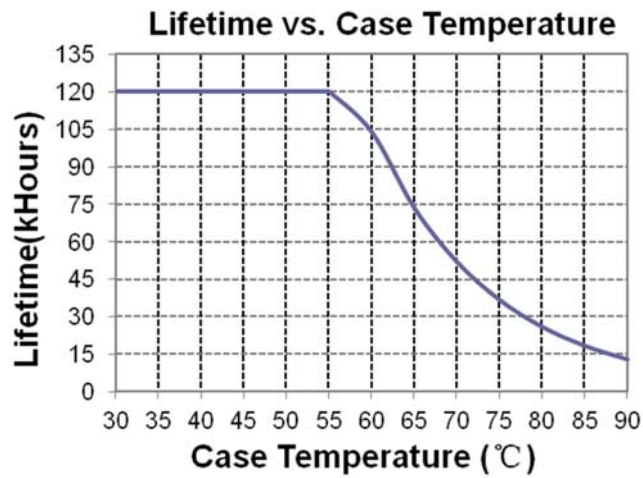

Inrush Current Waveform

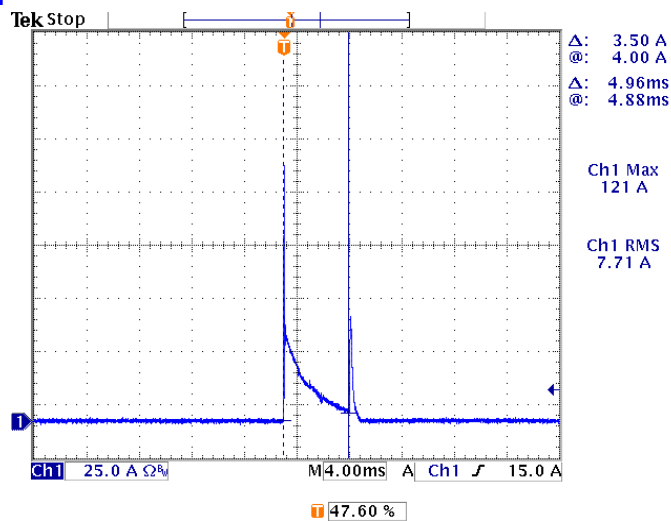

Efficiency vs. Load

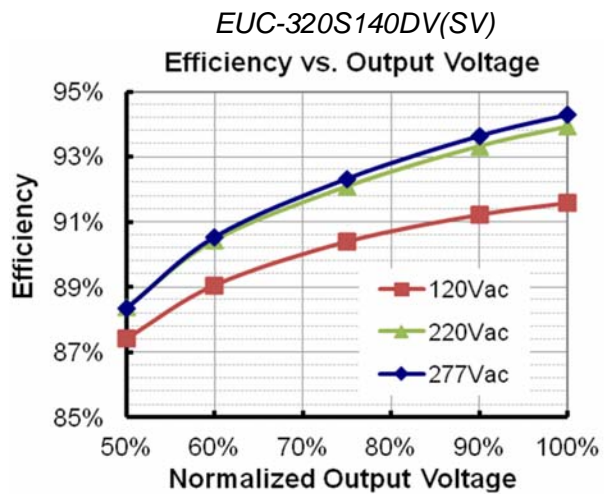
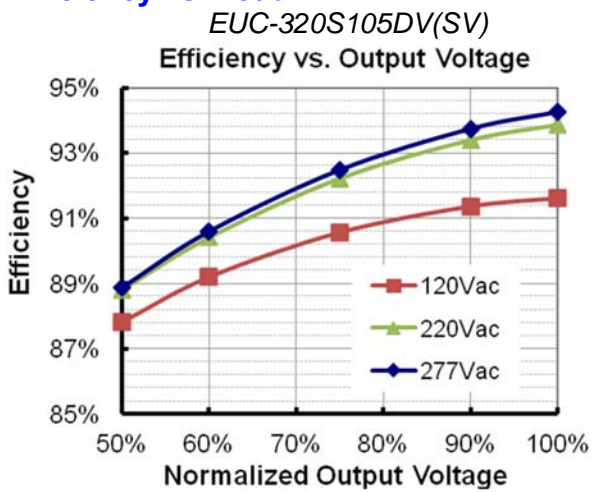

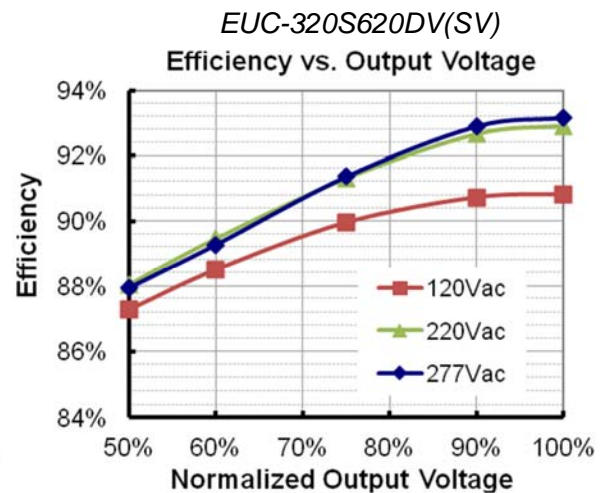
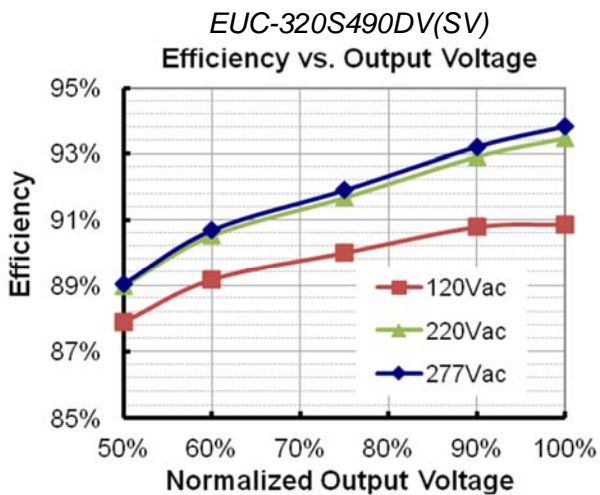
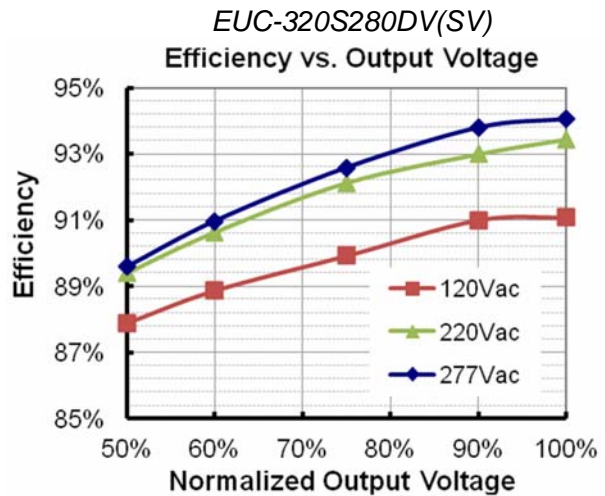
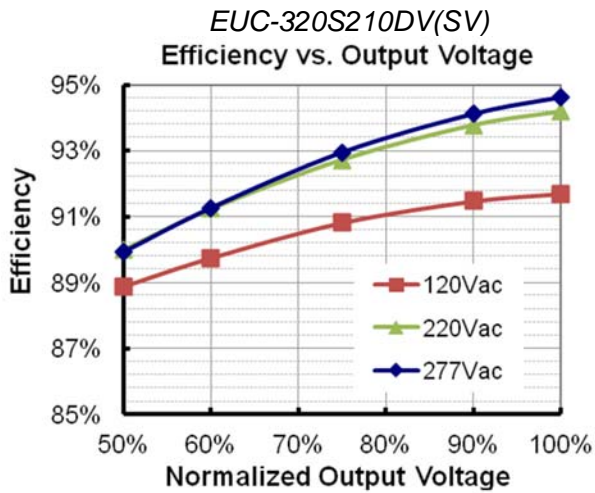

Power Factor

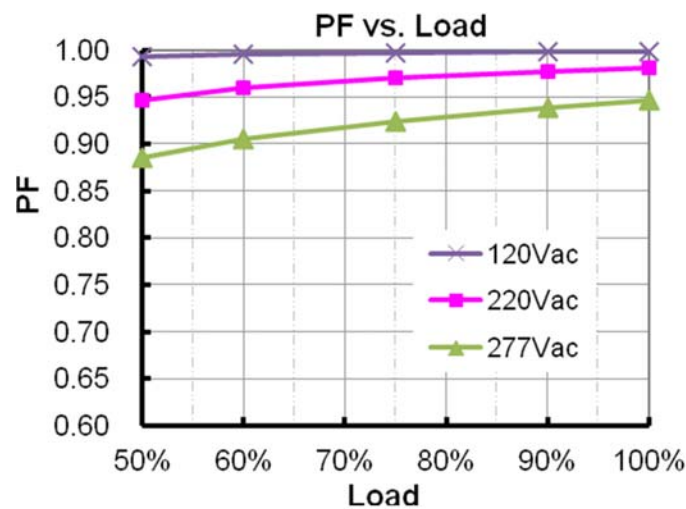

Total Harmonic Distortion

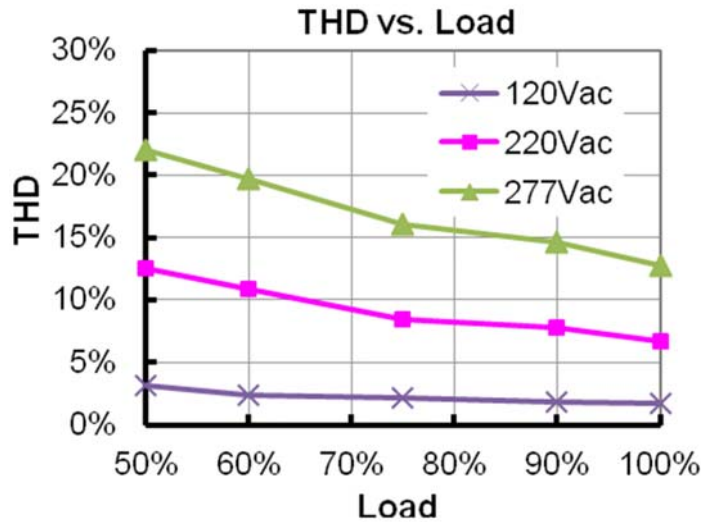

Protection Functions

Parameter	Notes
Over Temperature Protection	Decreases output current, returning to normal after over temperature is removed.
Short Circuit Protection	Auto Recovery. No damage will occur when any output is short circuited. The output shall return to normal when the fault condition is removed.
Over Voltage Protection	Limits output voltage at no load and in case the normal voltage limit fails.

Dimming

● 0-10V Dimming

Recommended implementations of the dimming control are provided below.

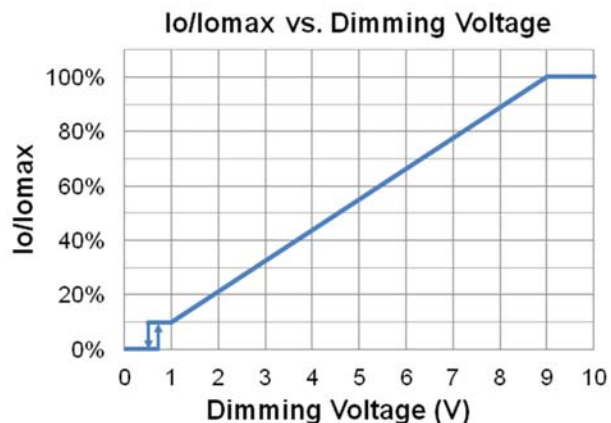
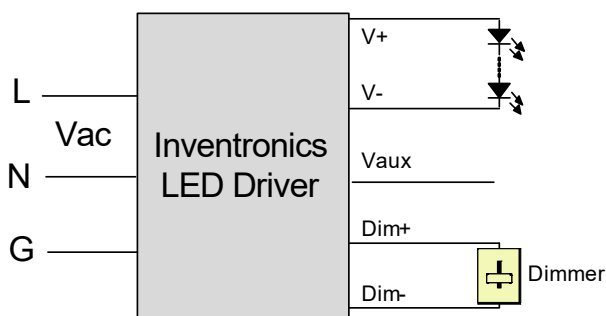

Implementation 1: DC Input

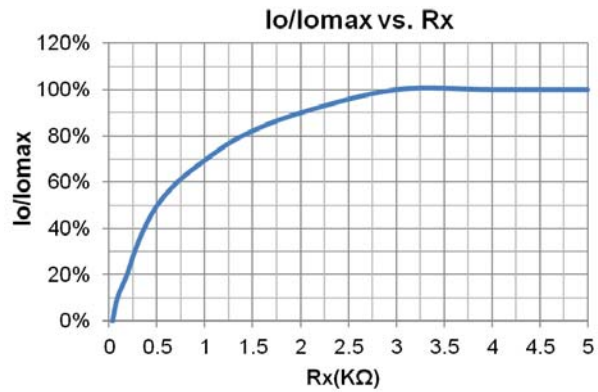
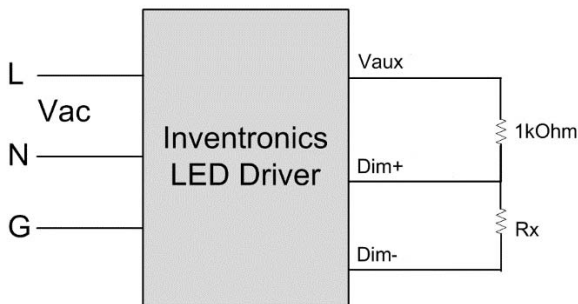

Implementation 2: External Resistor

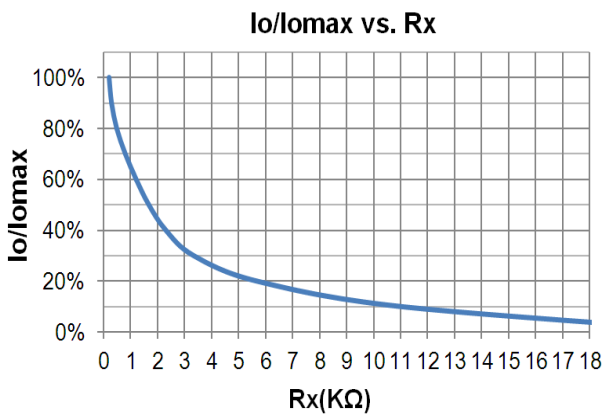
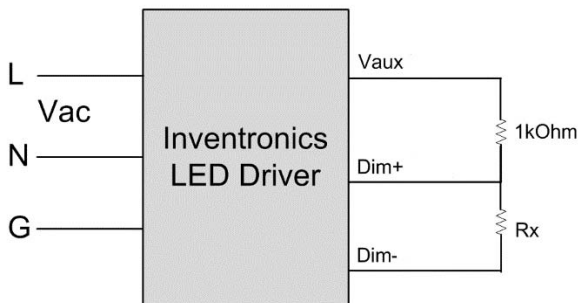

Implementation 3: External Resistor

Notes:

1. Do NOT connect Dim- to the output V- or V+, otherwise the driver will not work properly.
2. The dimmer can also be replaced by an active 0-10V voltage source signal or passive components like zener.
3. If 0-10V dimming is not used, Dim + can be either open or connected to Vaux.

● **0% Light Brightness**

If the brightness of the LED lighting fixture down to 0%, please refer to the following wiring method. The lamp can be turned on/off using a switch and relay.

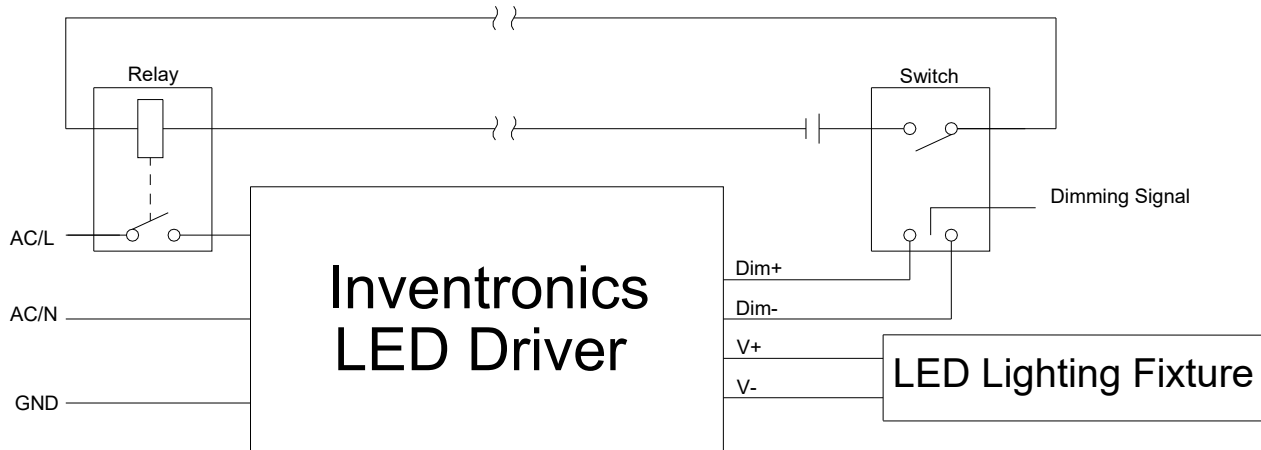

Implementation 4: 0% Light Brightness Wiring Method

Mechanical Outline

EUC-320SxxxDV

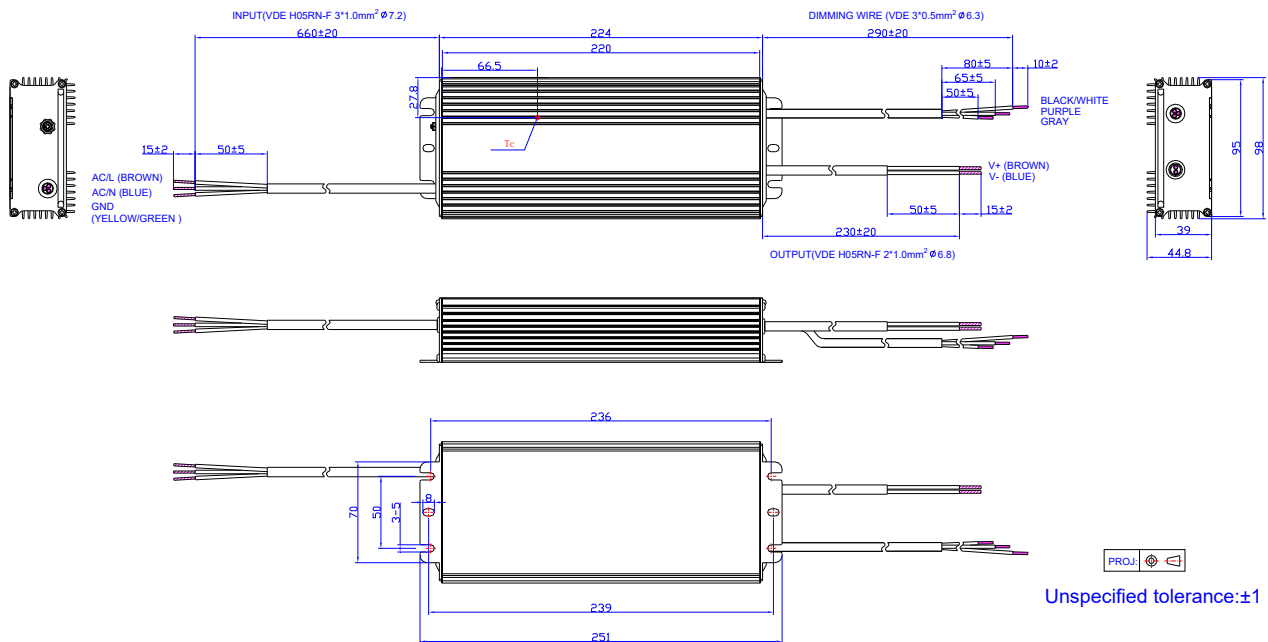

EUC-320SxxxSV

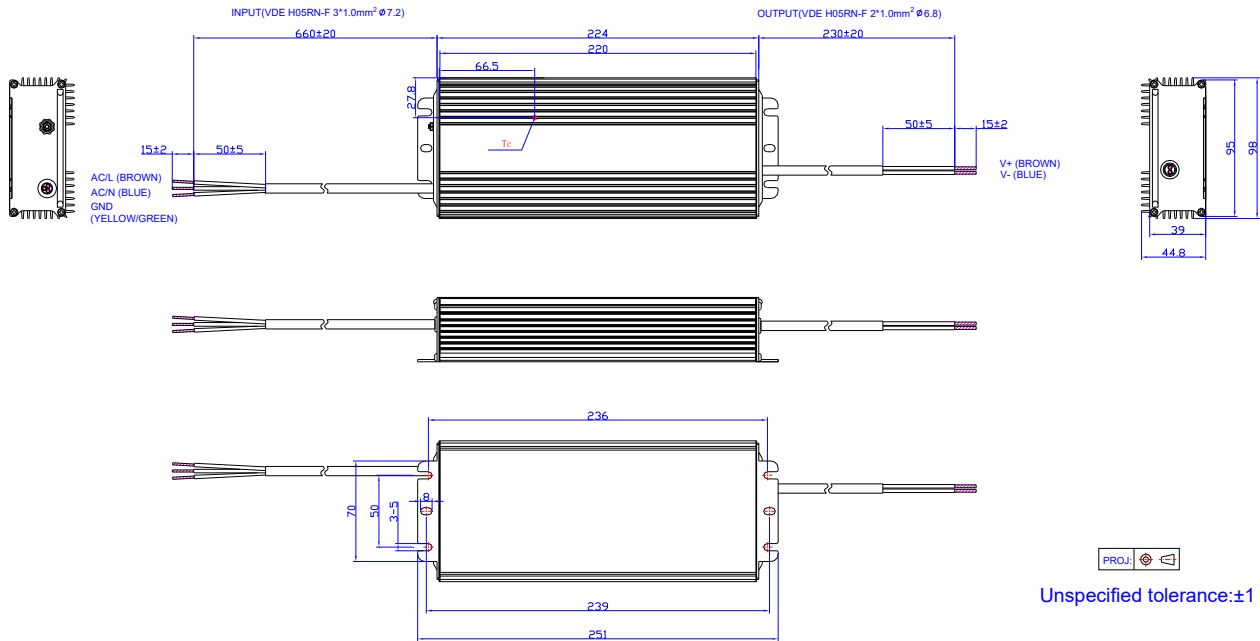

RoHS Compliance

Our products comply with reference to RoHS Directive (EU) 2015/863 amending 2011/65/EU, calling for the elimination of lead and other hazardous substances from electronic products.

Revision History

Change Date	Rev.	Description of Change		
		Item	From	To
2015-03-16	A	Datasheets Release	/	/
2015-06-01	B	Description	/	Updated
		Models	/	Updated
		Mechanical Outline	/	Updated
2015-11-30	C	PSE	/	Added
		Output Specifications	No load Output Voltage	Updated
2017-06-19	D	Global-mark/KC/BIS	/	Added
		Models	Notes	Updated
		Temperature Coefficient of Io	/	Updated
		General Specifications	With mounting ear	Added
		Safety & EMC Compliance	/	Updated
		Mechanical Outline	/	Updated
2021-11-11	E	TUV/PSE/BIS logo	/	Updated
		Features	/	Updated
		Input Specifications	Input DC voltage	Added
		Output Specifications	No load Output Voltage	Updated
		Operating Case Temperature for Safety Tc_s	/	Updated
		Operating Case Temperature for Warranty Tc_w	/	Updated
		Dimensions Inches (L x W x H) / Millimeters (L x W x H)	/	Updated
		Safety & EMC Compliance	ENEC & TUV	Added
		Safety & EMC Compliance	CB	Added
		Safety & EMC Compliance	CCC	Added
		Safety & EMC Compliance	PSE	Added
		Safety & EMC Compliance	BIS	Added
		Safety & EMC Compliance	Global Mark	Added
		Safety & EMC Compliance	KC	Added
Safety & EMC Compliance	EMI standard	Updated		

Revision History (Continued)

Change Date	Rev.	Description of Change		
		Item	From	To
2021-11-11	E	Safety & EMC Compliance	EN 61000-4-5	Updated
		Safety & EMC Compliance	Note (1)	Updated
		Dimming	Note	Updated
		0% Light Brightness	/	Added
		Mechanical Outline	/	Updated
		RoHS Compliance	/	Updated
		Footer	/	Updated