

## Features

- Ultra High Efficiency (Up to 91%)
- Full Power at Wide Output Current Range (Constant Power)
- Thermal Sensing and Protection for LED Module
- DALI/Timer Dimmable (3 Timer Modes)
- Dim-to-Off with Standby Power ≤ 0.5 W
- Always-on Auxiliary Power: 12Vdc, 200mA (Transient Peak Current up to 400mA)
- Output Lumen Compensation
- Input Surge Protection: 6kV line-line, 10kV line-earth
- All-Around Protection: OVP, SCP, OTP
- Waterproof (IP67)
- SELV Output
- Suitable for Independent Use
- 7 Years Warranty



## Description

The EUD-075SxxxBV series is a 75W, constant-current, programmable LED driver that operates from 90-305 Vac input with excellent power factor. Created for low bay, tunnel and street lights, it provides a dim-to-off mode with low standby power. The high efficiency of these drivers and compact metal case enables them to run cooler, significantly improving reliability and extending product life. To ensure trouble-free operation, protection is provided against input surge, output over voltage, short circuit, and over temperature.

## Models

Adjustable Output Current Range	Full-Power Current Range (1)	Default Output Current	Input Voltage Range(2)	Output Voltage Range	Max. Output Power	Typical Efficiency (3)	Power Factor		Model Number
							120Vac	220Vac	
45-700mA	450-700mA	530 mA	90~305 Vac/ 127~250 Vdc	54~167Vdc	75 W	91.0%	0.99	0.96	EUD-075S070BV
70-1050mA	700-1050mA	700 mA	90~305 Vac/ 127~250 Vdc	36~107Vdc	75 W	91.0%	0.99	0.96	EUD-075S105BV <sup>(4)</sup>
119-1750mA	1190-1750mA	1400 mA	90~305 Vac/ 127~250 Vdc	22 ~ 63Vdc	75 W	90.5%	0.99	0.96	EUD-075S175BV <sup>(4)</sup>
192-2800mA	1920-2800mA	2100 mA	90~305 Vac/ 127~250 Vdc	14 ~ 39Vdc	75 W	89.5%	0.99	0.96	EUD-075S280BV <sup>(4)</sup>

- Notes:** (1) Output current range with constant power at 75W  
 (2) Certified voltage range: 100-240Vac or 127-250Vdc (except CCC, PSE and KS).  
 (3) Measured at full load and 220Vac input (see below “General Specifications” for details).  
 (4) SELV Output

## I-V Operating Area

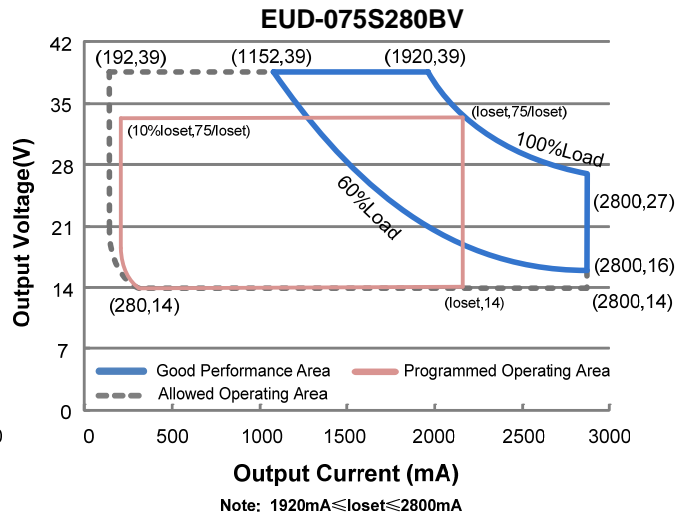
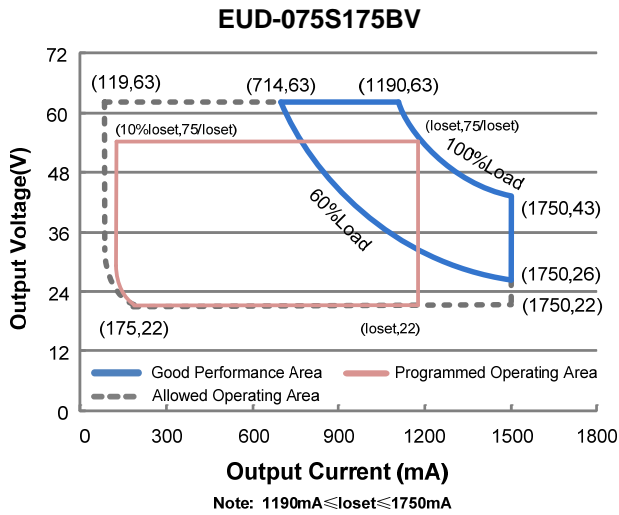
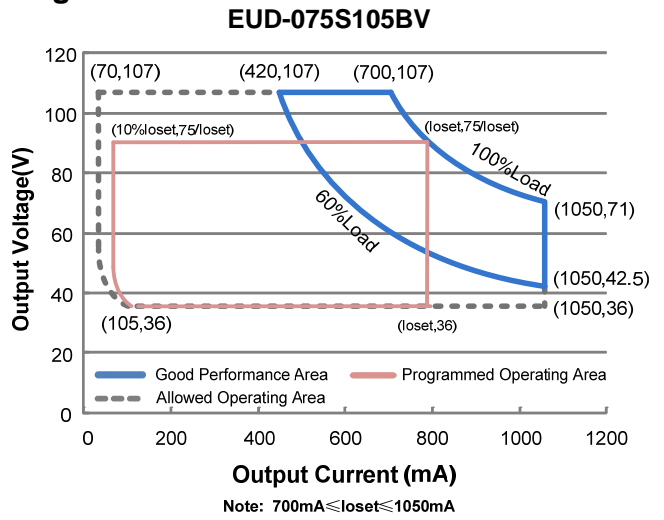
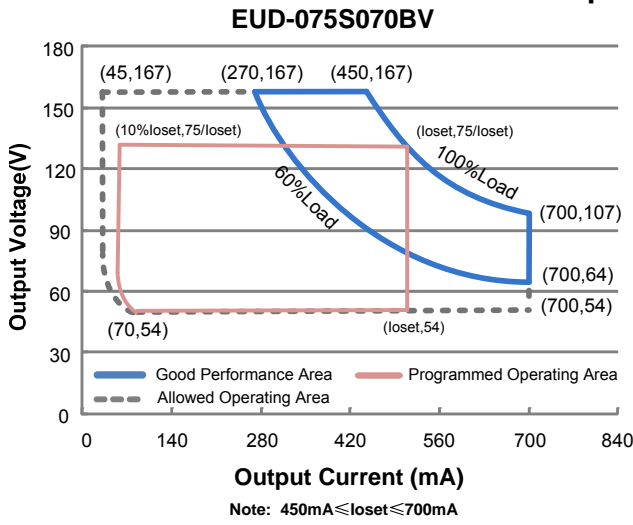

## Input Specifications

Parameter	Min.	Typ.	Max.	Notes
Input Voltage	90 Vac	-	305 Vac	127-250 Vdc
Input Frequency	47 Hz	-	63 Hz	
Leakage Current	-	-	0.70 mA	IEC60598-1; 240Vac/ 60Hz
Input AC Current	-	-	1.02 A	Measured at full load and 100 Vac input.
	-	-	0.48 A	Measured at full load and 220 Vac input.
Inrush Current ( $I^2t$ )	-	-	1.03 A <sup>2</sup> s	At 220Vac input, 25°C cold start, duration=740 μs, 10%lpk-10%lpk. See Inrush Current Waveform for the details.
PF	0.90	-	-	At 100-240Vac, 50-60Hz, 60%-100% Load (45-75W)
THD	-	-	20%	
THD	-	-	10%	At 220-240Vac, 50-60Hz, 75%-100% Load (56.25-75W)

## Output Specifications

Parameter	Min.	Typ.	Max.	Notes
Output Current Tolerance	-5%loset	-	5%loset	At full load condition
Output Current Setting(loset) Range				
EUD-075S070BV	45 mA	-	700 mA	
EUD-075S105BV	70 mA	-	1050 mA	
EUD-075S175BV	119 mA	-	1750 mA	
EUD-075S280BV	192 mA	-	2800 mA	
Output Current Setting Range with Constant Power				
EUD-075S070BV	450 mA	-	700 mA	
EUD-075S105BV	700 mA	-	1050 mA	
EUD-075S175BV	1190 mA	-	1750 mA	
EUD-075S280BV	1920 mA	-	2800 mA	
Total Output Current Ripple (pk-pk)	-	5%lomax	10%lomax	At full load condition, 20 MHz BW
Output Current Ripple at < 200 Hz (pk-pk)	-	1%lomax	-	At full load condition. Only this component of ripple is associated with visible flicker.
Startup Overshoot Current	-	-	10%lomax	At full load condition
No Load Output Voltage				
EUD-075S070BV	-	-	190 V	
EUD-075S105BV	-	-	120 V	
EUD-075S175BV	-	-	71 V	
EUD-075S280BV	-	-	45 V	
Line Regulation	-	-	±0.5%	Measured at full load
Load Regulation	-	-	±1.5%	
Turn-on Delay Time	-	-	1.0 s	Measured at 120Vac input, 60%-100% Load.
	-	-	0.5 s	Measured at 220Vac input, 60%-100% Load.
Temperature Coefficient of loset	-	0.03%/°C	-	Case temperature = 0°C ~Tc max
12V Auxiliary Output Voltage	10.8 V	12 V	13.2 V	
12V Auxiliary Output Source Current	0 mA	-	200 mA	Return terminal is "OTP"
12V Auxiliary Output Transient Peak Current	-	-	400 mA	400mA peak for a maximum duration of 30 0ms in a 2s period during which time the average should not exceed 200mA.

**Note:** All specifications are typical at 25°C unless otherwise stated.

## General Specifications

Parameter	Min.	Typ.	Max.	Notes
Efficiency at 120 Vac input: EUD-075S070BV				Measured at full load and steady-state temperature in 25°C ambient; (Efficiency will be about 2.0% lower if measured immediately after startup.)
Io= 450mA	86.5%	88.5%	-	
Io= 700mA	86.5%	88.5%	-	
EUD-075S105BV				
Io= 700mA	86.5%	88.5%	-	
Io=1050mA	86.0%	88.0%	-	
EUD-075S175BV				
Io=1190mA	86.5%	88.5%	-	
Io=1750mA	86.0%	88.0%	-	
EUD-075S280BV				
Io=1920mA	86.0%	88.0%	-	
Io=2800mA	85.0%	87.0%	-	
Efficiency at 220 Vac input: EUD-075S070BV				Measured at full load and steady-state temperature in 25°C ambient; (Efficiency will be about 2.0% lower if measured immediately after startup.)
Io= 450mA	89.0%	91.0%	-	
Io= 700mA	88.5%	90.5%	-	
EUD-075S105BV				
Io= 700mA	89.0%	91.0%	-	
Io=1050mA	88.5%	90.5%	-	
EUD-075S175BV				
Io=1190mA	88.5%	90.5%	-	
Io=1750mA	88.0%	90.0%	-	
EUD-075S280BV				
Io=1920mA	87.5%	89.5%	-	
Io=2800mA	87.0%	89.0%	-	
Efficiency at 277 Vac input: EUD-075S070BV				Measured at full load and steady-state temperature in 25°C ambient; (Efficiency will be about 2.0% lower if measured immediately after startup.)
Io= 450mA	89.0%	91.0%	-	
Io= 700mA	89.0%	91.0%	-	
EUD-075S105BV				
Io= 700mA	89.0%	91.0%	-	
Io=1050mA	89.0%	91.0%	-	
EUD-075S175BV				
Io=1190mA	89.0%	91.0%	-	
Io=1750mA	88.0%	90.0%	-	
EUD-075S280BV				
Io=1920mA	88.0%	90.0%	-	
Io=2800mA	87.0%	89.0%	-	
Standby power	-	-	0.5 W	Measured at 230Vac/50Hz; Dimming off
MTBF	-	219,000 Hours	-	Measured at 220Vac input, 80%Load and 25°C ambient temperature (MIL-HDBK-217F)
Lifetime	-	98,000 Hours	-	Measured at 220Vac input, 80%Load and 70°C case temperature; See lifetime vs. Tc curve for the details
Operating Case Temperature for Safety Tc_s	-40°C	-	+90°C	
Operating Case Temperature for Warranty Tc_w	-40°C	-	+75°C	Case temperature for 7 years warranty. Please see <i>Inventronics Warranty Statement for complete details.</i>
Storage Temperature	-40°C	-	+85°C	Humidity: 5%RH to 100%RH
Dimensions				With mounting ear
Inches (L × W × H)	6.10 × 2.66 × 1.44			7.17 × 2.66 × 1.44
Millimeters (L × W × H)	155 × 67.5 × 36.5			182 × 67.5 × 36.5
Net Weight	-	820 g	-	

**Note:** All specifications are typical at 25°C unless otherwise stated.

## Dimming Specifications

Parameter		Min.	Typ.	Max.	Notes
DA, DA High Level		9.5V	16V	22.5V	
DA, DA Low Level		-6.5V	0V	6.5V	
DA, DA Current		0mA	-	2mA	
Dimming Output Range	EUD-075S070BV EUD-075S105BV EUD-075S175BV EUD-075S280BV	10%loset	-	loset	450 mA ≤ loset ≤ 700 mA 700 mA ≤ loset ≤ 1050 mA 1190 mA ≤ loset ≤ 1750 mA 1920 mA ≤ loset ≤ 2800 mA
	EUD-075S070BV EUD-075S105BV EUD-075S175BV EUD-075S280BV	45 mA 70 mA 119 mA 192 mA	-	loset	45 mA ≤ loset < 450 mA 70 mA ≤ loset < 700 mA 119 mA ≤ loset < 1190 mA 192 mA ≤ loset < 1920 mA

**Note:** All specifications are typical at 25 °C unless stated otherwise.

## Standards Compliance

Safety Category	Standard
CE	EN 61347-1, EN61347-2-13
KS	KS C 7655
EMI Standards	Notes
EN 55015 <sup>(1)</sup>	Conducted emission Test & Radiated emission Test
EN 61000-3-2	Harmonic current emissions
EN 61000-3-3	Voltage fluctuations & flicker
EMS Standards	Notes
EN 61000-4-2	Electrostatic Discharge (ESD): 8 kV air discharge, 4 kV contact discharge
EN 61000-4-3	Radio-Frequency Electromagnetic Field Susceptibility Test-RS
EN 61000-4-4	Electrical Fast Transient / Burst-EFT
EN 61000-4-5	Surge Immunity Test: AC Power Line: line to line 6 kV, line to earth 10 kV <sup>(2)</sup>
EN 61000-4-6	Conducted Radio Frequency Disturbances Test-CS
EN 61000-4-8	Power Frequency Magnetic Field Test
EN 61000-4-11	Voltage Dips
EN 61547	Electromagnetic Immunity Requirements Applies To Lighting Equipment
DALI Standards	Notes
DALI	IEC62386-101,102 & part of 207 <sup>(3)</sup>

**Note:** (1) This LED driver meets the EMI specifications above, but EMI performance of a luminaire that contains it depends also on the other devices connected to the driver and on the fixture itself.

(2) To perform electric strength (hi-pot) testing, the “GDT ground disconnect” (nut and metal lock sheet) on the driver end-cap should be removed temporarily to prevent the internal gas discharge tube from conducting (as allowed by IEC 60598-1 Clause 10.2). After testing is completed, these items must be reinstalled to restore line-to-earth surge protection and secure the end cap.

(3) Optional Commands Implemented: 242 (query short circuit), 243 (query open circuit)

## Lifetime vs. Case Temperature

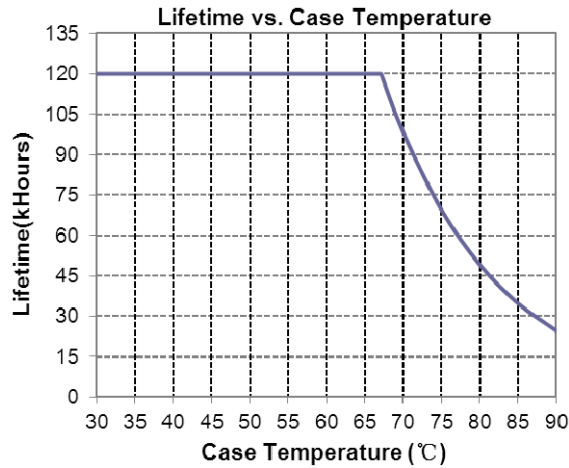

## Inrush Current Waveform

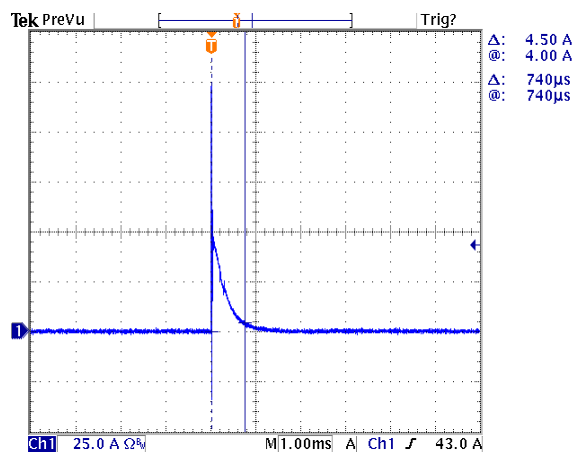

## Efficiency vs. Load

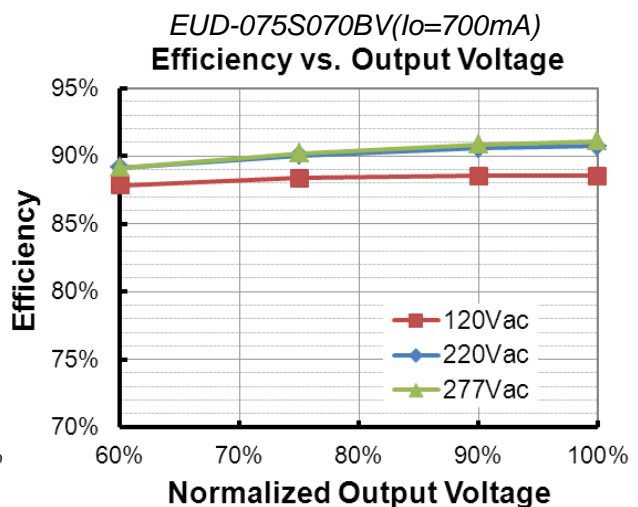
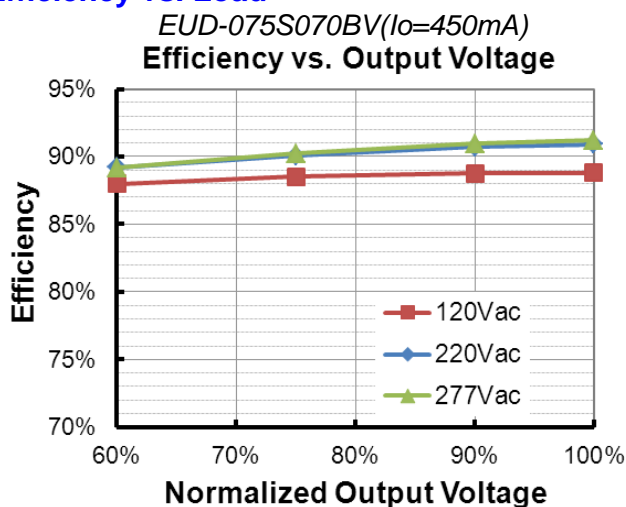

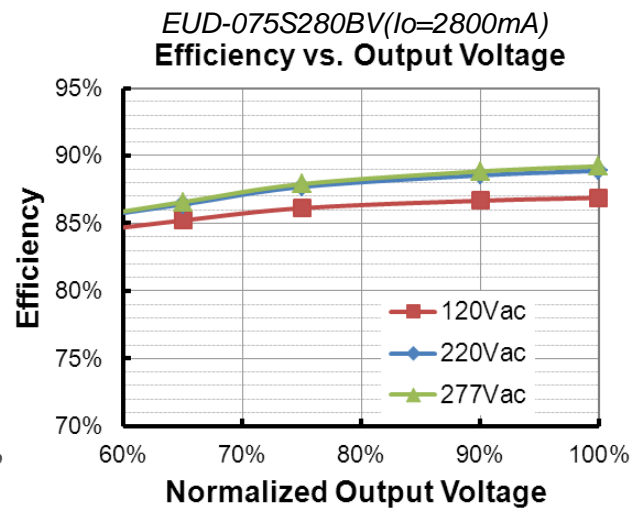
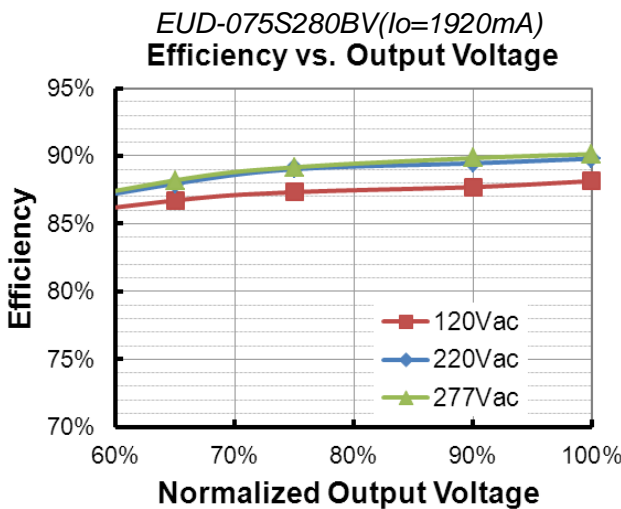
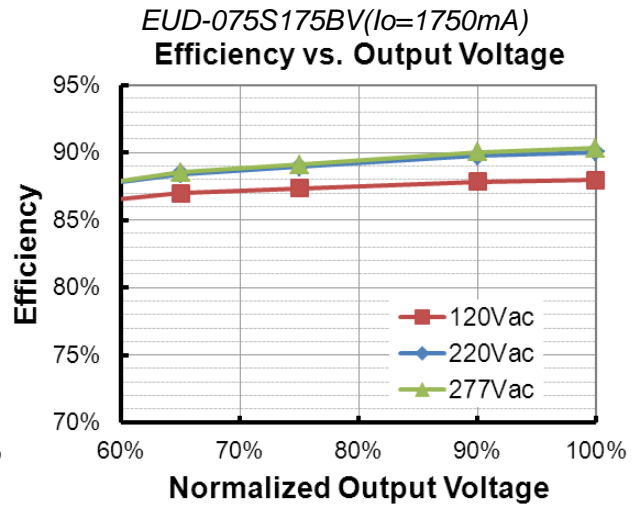
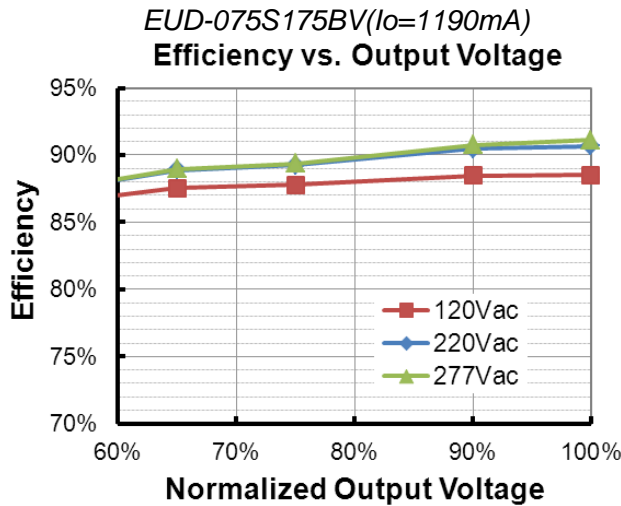
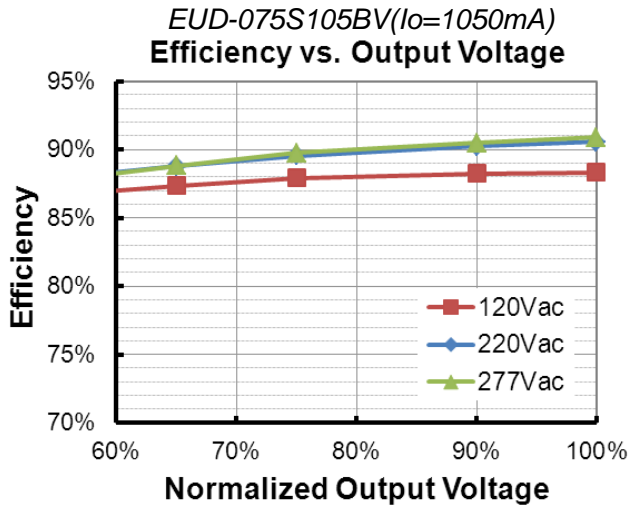
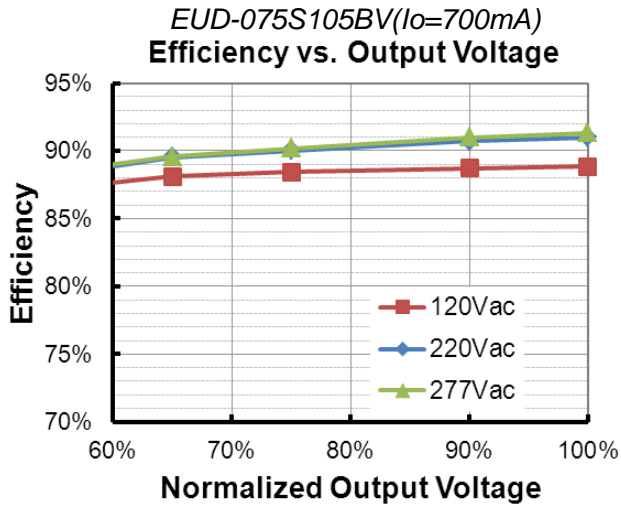

## Power Factor

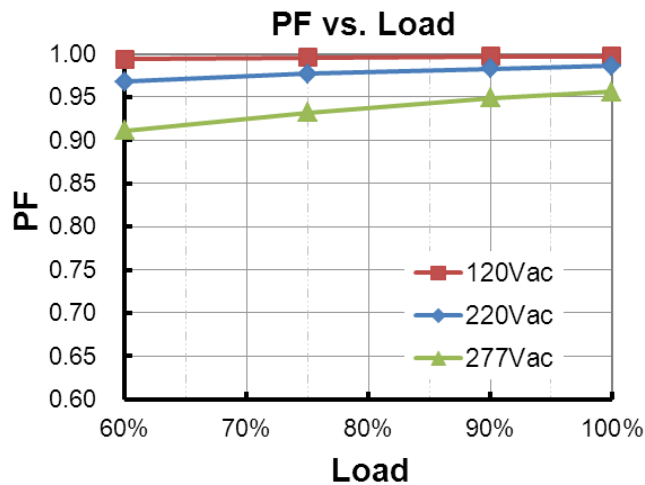

## Total Harmonic Distortion

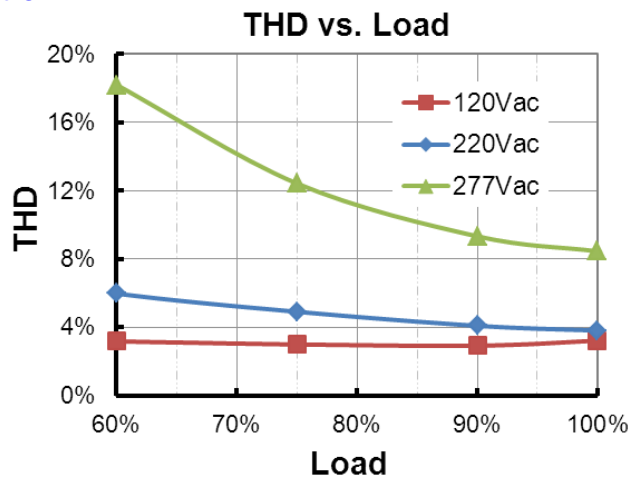

## Protection Functions

Parameter		Min.	Typ.	Max.	Notes
External Thermal Protection NTC	R1	-	7.81 kOhm	-	When R_NTC falls below R1, External Thermal Protection is triggered, reducing output current until R2 is reached.
	R2	-	4.16 kOhm	-	When R_NTC is less than R2, output current is reduced to the programmed "Protection Current Floor."
	Protection Current Floor	10%loset	60%loset	100%loset	10%loset > I <sub>omin</sub> (default setting is 60%)
		I <sub>omin</sub>	60%loset	100%loset	10%loset ≤ I <sub>omin</sub> (default setting is 60%)
Over Temperature Protection		Decreases output current, returning to normal after over temperature is removed.			
Short Circuit Protection		Auto Recovery. No damage will occur when any output is short circuited. The output shall return to normal when the fault condition is removed.			
Over Voltage Protection		Limits output voltage at no load and in case the normal voltage limit fails.			



## Dimming

### ● DALI Dimming

The recommended implementation of the dimming control is provided below.

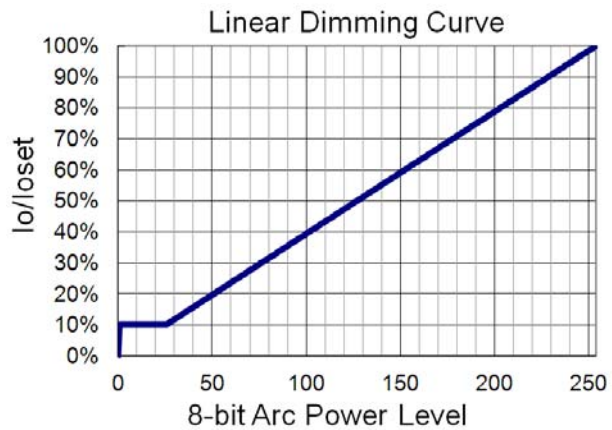
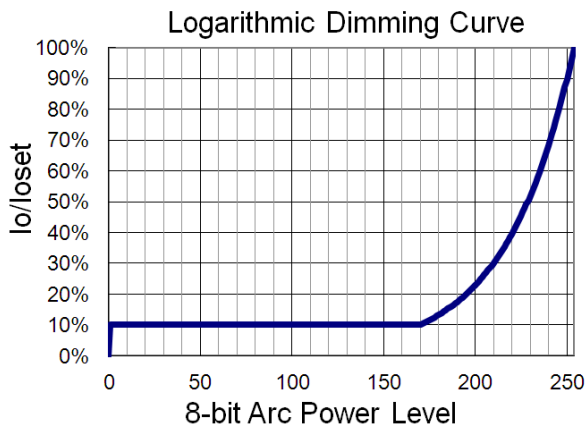
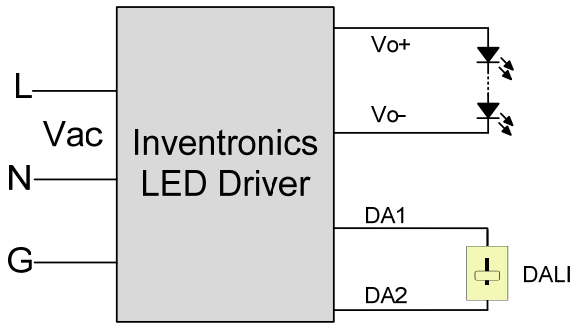

Implementation: DALI Dimming

### ● Time Dimming

Time dimming control includes 3 kinds of modes, they are Self Adapting-Midnight, Self Adapting-Percentage and Traditional Timer.

- **Self Adapting-Midnight:** Automatically adjusts the dimming curve based on the on-time of past two days (if difference <15 minutes), assuming that the center point of the dimming curve is midnight local time.
- **Self Adapting-Percentage:** Automatically adjusts the on-time of each step by a constant percentage = (actual on-time for the past 2 days if difference <15 min) / (programmed on-time from the dimming curve).
- **Traditional Timer:** Follows the programmed timing curve after power on with no changes.

### ● Output Lumen Compensation

Output Lumen Compensation (OLC) may be used to maintain constant light output over the life of the LEDs by driving them at a reduced current when new, then gradually increasing the drive current over time to counteract LED lumen degradation.

## Programming Connection Diagram

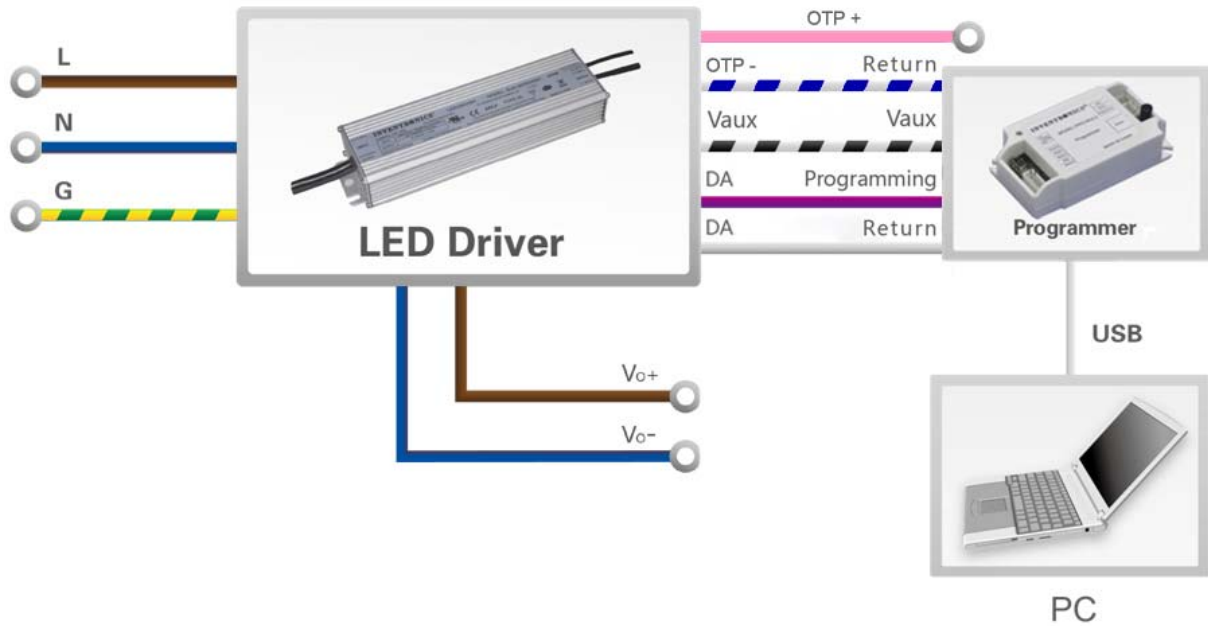

**Note:** The driver does not need to be powered on during the programming process.

- Please refer to [PRG-MUL2](#) (Programmer) datasheet for details.

## Mechanical Outline

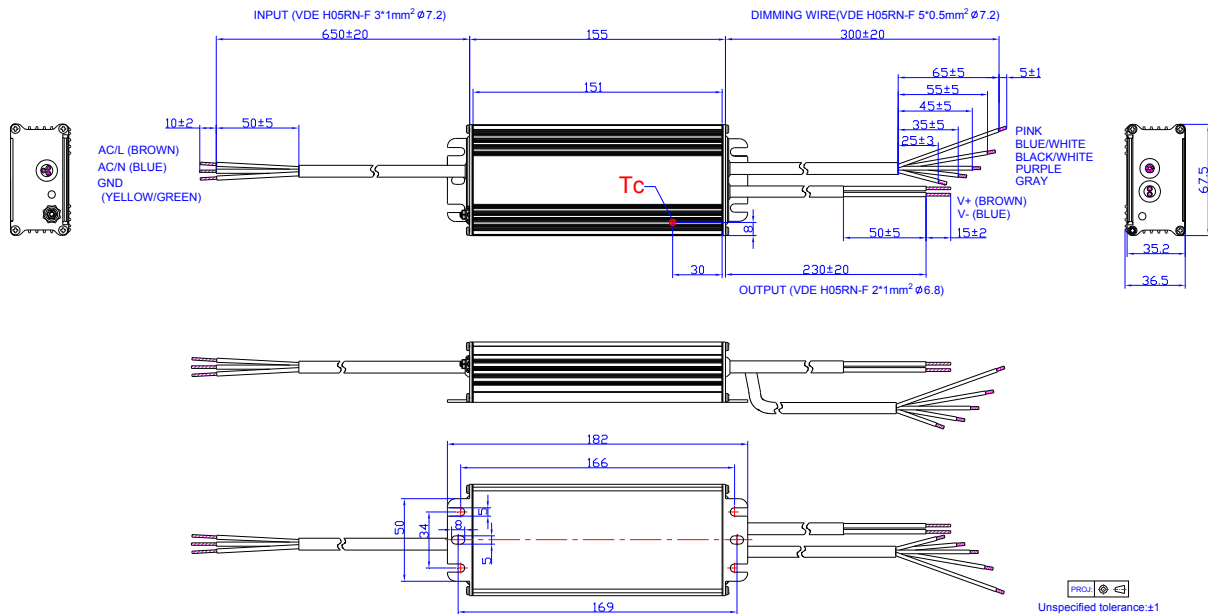

## RoHS Compliance

Our products comply with the European Directive 2011/65/EC, calling for the elimination of lead and other hazardous substances from electronic products.

## Revision History

Change Date	Rev.	Description of Change		
		Item	From	To
2017-04-19	A	Datasheets Created	/	/
2017-10-27	B	Features	7 Years Warranty	Added
		Input Specifications	PF/THD	Updated
		Operating Case Temperature for Warranty T <sub>c_w</sub>	/	Updated