

Features

- Ultra High Efficiency (Up to 94%)
- Full Power at Wide Output Current Range (Constant Power)
- Thermal Sensing and Protection for LED Module
- 0-10V/PWM/3-Timer-Modes Dimmable (DTA models)
DALI Dimming Control (BTA models)
- Dim-to-Off with Standby Power ≤ 0.5 W
- Always-on Auxiliary Power: 12Vdc, 200mA (Transient Peak Current up to 400mA)
- Output Lumen Compensation (DTA models)
- Input Surge Protection: DM 6kV, CM 10kV
- All-Around Protection: OVP, SCP, OTP
- IP67 and UL Dry/Damp/Wet Location
- SELV Output
- TYPE HL, for use in a Class I, Division 2 hazardous (Classified) location
- 7 Years Warranty



Description

The EUD-150SxxxDTA(BTA) series is a 150W, constant-current, programmable LED driver that operates from 90-305 Vac input with excellent power factor. Created for many lighting applications including high bay, tunnel and roadway, it provides a dim-to-off mode with low standby power. The high efficiency of these drivers and compact metal case enables them to run cooler, significantly improving reliability and extending product life. To ensure trouble-free operation, protection is provided against input surge, output over voltage, short circuit, and over temperature.

Models

Adjustable Output Current Range	Full-Power Current Range (1)	Default Output Current	Input Voltage Range(2)	Output Voltage Range	Max. Output Power	Typical Efficiency (3)	Typical Power Factor		Model Number
							120Vac	220Vac	
70-1050mA	700-1050mA	700 mA	90 ~ 305 Vac 100 ~ 300 Vdc	75~214Vdc	150 W	94.0%	0.99	0.96	EUD-150S105DTA(BTA)
140-2100mA	1400-2100mA	1400 mA	90 ~ 305 Vac 100 ~ 300 Vdc	88~107Vdc	150 W	94.0%	0.99	0.96	EUD-150S210DTA(BTA) ⁽⁴⁾
245-3500mA	2450-3500mA	3150 mA	90 ~ 305 Vac 100 ~ 300 Vdc	22 ~ 61Vdc	150 W	93.5%	0.99	0.96	EUD-150S350DTA(BTA) ⁽⁴⁾
385-5600mA	3850-5600mA	4200 mA	90 ~ 305 Vac 100 ~ 300 Vdc	14 ~ 39Vdc	150 W	92.5%	0.99	0.96	EUD-150S560DTA(BTA) ⁽⁴⁾

Notes: (1) Output current range with constant power at 150W

(2) Certified voltage range: UL, FCC 100-277Vac or 100-300Vdc; otherwise 100-240Vac or 100-250Vdc (except KS)

(3) Measured at 100% load and 220Vac input (see below "General Specifications" for details).

(4) SELV Output

I-V Operating Area

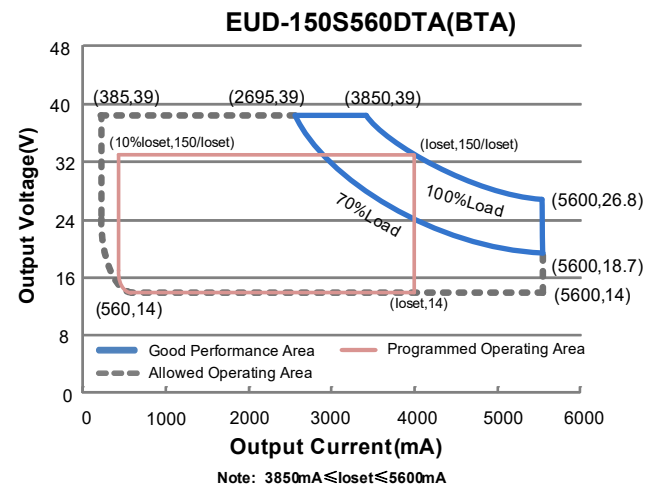
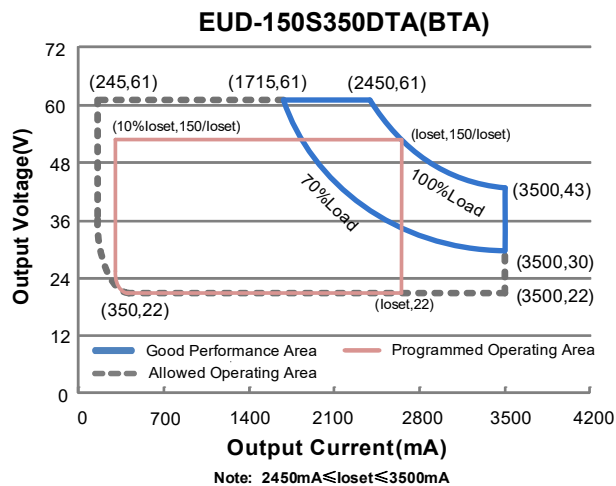
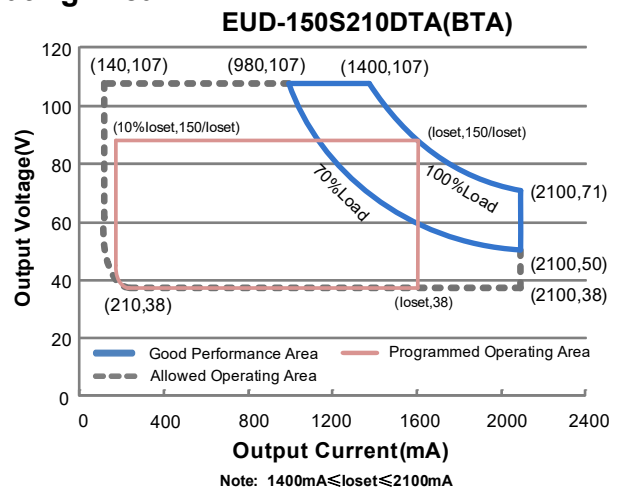
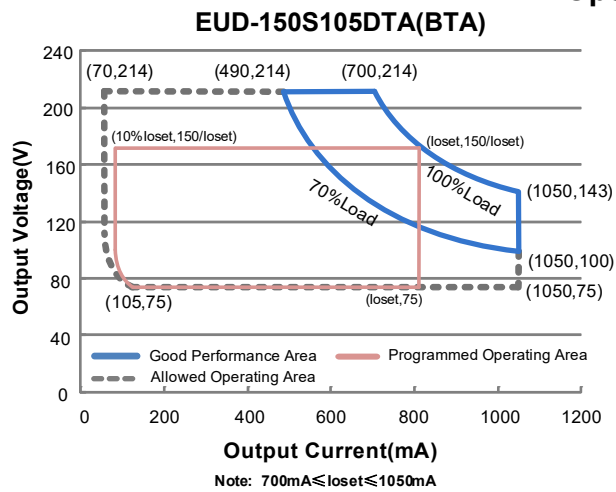

Input Specifications

Parameter	Min.	Typ.	Max.	Notes
Input AC Voltage	90 Vac	-	305 Vac	
Input DC Voltage	100 Vdc	-	300 Vdc	
Input Frequency	47 Hz	-	63 Hz	
Leakage Current	-	-	0.75 MIU	UL8750; 277Vac/ 60Hz, grounding effectively
	-	-	0.70 mA	IEC60598-1; 240Vac/ 60Hz, grounding effectively
Input AC Current	-	-	1.87 A	Measured at 100% load and 100 Vac input.
	-	-	0.85 A	Measured at 100% load and 220 Vac input.

Input Specifications (Continued)

Parameter	Min.	Typ.	Max.	Notes
Inrush Current(I ² t)	-	-	1.90 A ² s	At 220Vac input, 25°C cold start, duration=872μs, 10%Ipk-10%Ipk. See Inrush Current Waveform for the details.
PF	0.90	-	-	At 100-277Vac, 50-60Hz, 70%-100% Load (105-150W)
THD	-	-	20%	
THD	-	-	10%	At 220-240Vac, 50-60Hz, 75%-100% Load (112.5-150W)

Output Specifications

Parameter	Min.	Typ.	Max.	Notes
Output Current Tolerance	-5%loset	-	5%loset	100% load
Output Current Setting(loset) Range				
EUD-150S105DTA(BTA)	70 mA	-	1050 mA	
EUD-150S210DTA(BTA)	140 mA	-	2100 mA	
EUD-150S350DTA(BTA)	245 mA	-	3500 mA	
EUD-150S560DTA(BTA)	385 mA	-	5600 mA	
Output Current Setting Range with Constant Power				
EUD-150S105DTA(BTA)	700 mA	-	1050 mA	
EUD-150S210DTA(BTA)	1400 mA	-	2100 mA	
EUD-150S350DTA(BTA)	2450 mA	-	3500 mA	
EUD-150S560DTA(BTA)	3850 mA	-	5600 mA	
Total Output Current Ripple (pk-pk)	-	5%lomax	10%lomax	100% load, 20 MHz BW
Output Current Ripple at < 200 Hz (pk-pk)	-	2%lomax	-	100% load.
Startup Overshoot Current	-	-	10%lomax	100% load
No Load Output Voltage				
EUD-150S105DTA(BTA)	-	-	240 V	
EUD-150S210DTA(BTA)	-	-	120 V	
EUD-150S350DTA(BTA)	-	-	80 V	
EUD-150S560DTA(BTA)	-	-	50 V	
Line Regulation	-	-	±0.5%	Measured at 100% load
Load Regulation	-	-	±1.5%	
Turn-on Delay Time	-	-	1.0 s	Measured at 120Vac input, 70%-100% Load
	-	-	0.5 s	Measured at 220Vac input, 70%-100% Load
Temperature Coefficient of loset	-	0.03%/°C	-	Case temperature = 0°C ~Tc max
12V Auxiliary Output Voltage	10.8 V	12 V	13.2 V	
12V Auxiliary Output Source Current	0 mA	-	200 mA	Return terminal is "Dim-"(DTA models) Return terminal is "OTP-"(BTA models)
12V Auxiliary Output Transient Peak Current	-	-	400 mA	400mA peak for a maximum duration of 300ms in a 2s period during which time the average should not exceed 200mA.

General Specifications

Parameter	Min.	Typ.	Max.	Notes	
Efficiency at 120 Vac input: EUD-150S105DTA(BTA) I _o = 700mA I _o =1050mA EUD-150S210DTA(BTA) I _o =1400mA I _o =2100mA EUD-150S350DTA(BTA) I _o =2450mA I _o =3500mA EUD-150S560DTA(BTA) I _o =3850mA I _o =5600mA	89.5% 88.0%	91.5% 90.0%	- -	Measured at 100% load and steady-state temperature in 25°C ambient; (Efficiency will be about 2.0% lower if measured immediately after startup.)	
Efficiency at 220 Vac input: EUD-150S105DTA(BTA) I _o = 700mA I _o =1050mA EUD-150S210DTA(BTA) I _o =1400mA I _o =2100mA EUD-150S350DTA(BTA) I _o =2450mA I _o =3500mA EUD-150S560DTA(BTA) I _o =3850mA I _o =5600mA	92.0% 90.5%	94.0% 92.5%	- -		
Efficiency at 277 Vac input: EUD-150S105DTA(BTA) I _o = 700mA I _o =1050mA EUD-150S210DTA(BTA) I _o =1400mA I _o =2100mA EUD-150S350DTA(BTA) I _o =2450mA I _o =3500mA EUD-150S560DTA(BTA) I _o =3850mA I _o =5600mA	92.0% 90.5%	94.0% 92.5%	- -		
Standby power	-	-	0.5 W		Measured at 230Vac/50Hz; Dimming off
MTBF	-	228,000 Hours	-		Measured at 220Vac input, 80%Load and 25°C ambient temperature (MIL-HDBK-217F)
Lifetime	-	100,000 Hours	-		Measured at 220Vac input, 80%Load and 70°C case temperature; See lifetime vs. T _c curve for the details
Operating Case Temperature for Safety T _{c_s}	-40°C	-	+89°C		
Operating Case Temperature for Warranty T _{c_w}	-40°C	-	+75°C		Case temperature for 7 years warranty. <i>Please see Inventronics Warranty Statement for complete details.</i> Humidity: 10%RH to 95%RH
Storage Temperature	-40°C	-	+85°C		Humidity: 5%RH to 95%RH

General Specifications (Continued)

Parameter	Min.	Typ.	Max.	Notes
Dimensions Inches (L × W × H) Millimeters (L × W × H)		8.03 × 2.66 × 1.56 204 × 67.5 × 39.7		With mounting ear 8.86 × 2.66 × 1.56 225 × 67.5 × 39.7
Net Weight	-	1150 g	-	

Dimming Specifications

Parameter	Min.	Typ.	Max.	Notes	
DTA Models	Absolute Maximum Voltage on the Vdim	-20 V	-	20 V	
	Source Current on Vdim (+)Pin	200 uA	300 uA	450 uA	Vdim(+) = 0 V
	Recommended Dimming Input Range	0 V	-	10 V	Default 0-10V dimming mode.
	Dim off Voltage	0.35 V	0.5 V	0.65 V	
	Dim on Voltage	0.55 V	0.7 V	0.85 V	
	Hysteresis	-	0.2 V	-	
	Recommended Dimming Input Range	0 V	-	10 V	Dimming mode set to PWM in PC interface.
	Dim off Voltage	0.35 V	0.5 V	0.65 V	
	Dim on Voltage	0.55 V	0.7 V	0.85 V	
	Hysteresis	-	0.2 V	-	
	PWM_in High Level	3 V	-	10 V	
	PWM_in Low Level	-0.3 V	-	0.6 V	
	PWM_in Frequency Range	200 Hz	-	3 KHz	
	PWM_in Duty Cycle	1%	-	99%	
	PWM Dimming off (Positive Logic)	2%	5%	8%	
	PWM Dimming on (Positive Logic)	4%	7%	10%	
	PWM Dimming off (Negative Logic)	92%	95%	98%	
	PWM Dimming on (Negative Logic)	90%	93%	96%	
Hysteresis	-	2%	-		
BTA Models	DA, DA High Level	9.5V	16V	22.5V	
	DA, DA Low Level	-6.5V	0V	6.5V	
	DA, DA Current	0mA	-	2mA	

Dimming Specifications (Continued)

Parameter		Min.	Typ.	Max.	Notes
Dimming Output Range	EUD-150S105DTA(BTA) EUD-150S210DTA(BTA) EUD-150S350DTA(BTA) EUD-150S560DTA(BTA)	10%loset	-	loset	700mA ≤ loset ≤ 1050mA 1400mA ≤ loset ≤ 2100mA 2450mA ≤ loset ≤ 3500mA 3850mA ≤ loset ≤ 5600mA
		70mA 140mA 245mA 385mA	-	loset	70mA ≤ loset < 700mA 140mA ≤ loset < 1400mA 245mA ≤ loset < 2450mA 385mA ≤ loset < 3850mA

Safety & EMC Compliance

Safety Category	Standard
UL/CUL	UL8750,CAN/CSA-C22.2 No. 250.13
CE	EN 61347-1, EN 61347-2-13
KS	KS C 7655
EMI Standards	Notes
EN 55015 ⁽¹⁾	Conducted emission Test & Radiated emission Test
EN 61000-3-2	Harmonic current emissions
EN 61000-3-3	Voltage fluctuations & flicker
FCC Part 15 ⁽¹⁾	ANSI C63.4 Class B
	This device complies with Part 15 of the FCC Rules. Operation is subject to the following two conditions: [1] this device may not cause harmful interference, and [2] this device must accept any interference received, including interference that may cause undesired Operation.
EMS Standards	Notes
EN 61000-4-2	Electrostatic Discharge (ESD): 8 kV air discharge, 4 kV contact discharge
EN 61000-4-3	Radio-Frequency Electromagnetic Field Susceptibility Test-RS
EN 61000-4-4	Electrical Fast Transient / Burst-EFT
EN 61000-4-5	Surge Immunity Test: AC Power Line: Differential Mode 6 kV, Common Mode 10 kV ⁽²⁾
EN 61000-4-6	Conducted Radio Frequency Disturbances Test-CS
EN 61000-4-8	Power Frequency Magnetic Field Test
EN 61000-4-11	Voltage Dips
EN 61547	Electromagnetic Immunity Requirements Applies To Lighting Equipment
DALI Standards	Notes
DALI	IEC62386-101,102 & part of 207 ⁽³⁾

Note: (1) This LED driver meets the EMI specifications above, but EMI performance of a luminaire that contains it depends also on the other devices connected to the driver and on the fixture itself.

- (2) To perform electric strength (hi-pot) testing, the "GDT ground disconnect" (nut and metal lock sheet) on the driver end-cap should be removed temporarily to prevent the internal gas discharge tube from conducting (as allowed by IEC 60598-1 Clause 10.2). After testing is completed, these items must be reinstalled to restore line-to-earth surge protection and secure the end cap.
- (3) Optional Commands Implemented: 242 (query short circuit), 243 (query open circuit)

Lifetime vs. Case Temperature

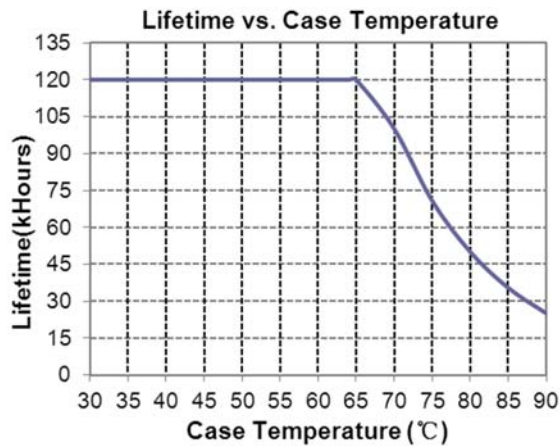

Inrush Current Waveform

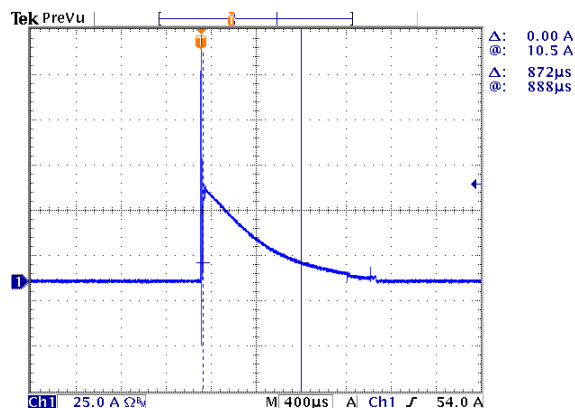

Efficiency vs. Load

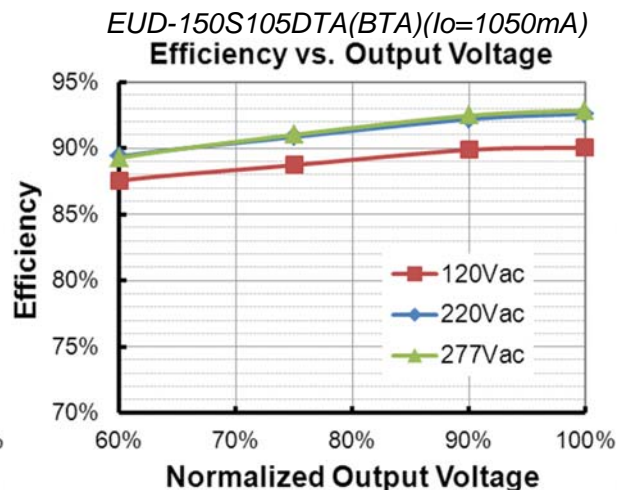
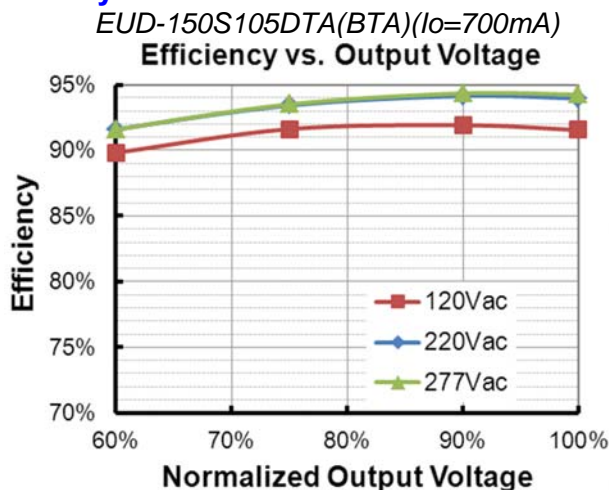

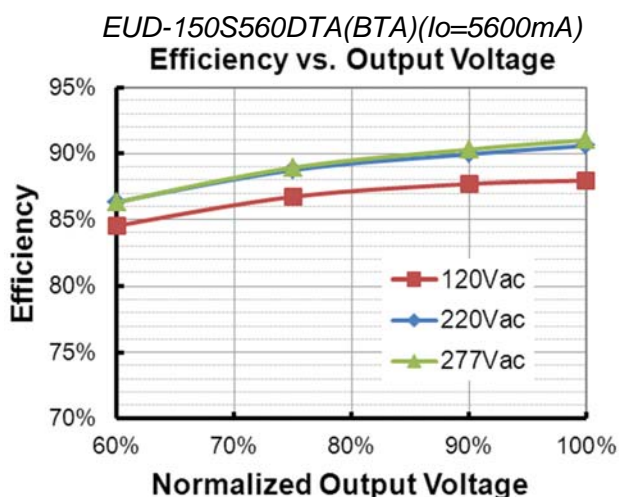
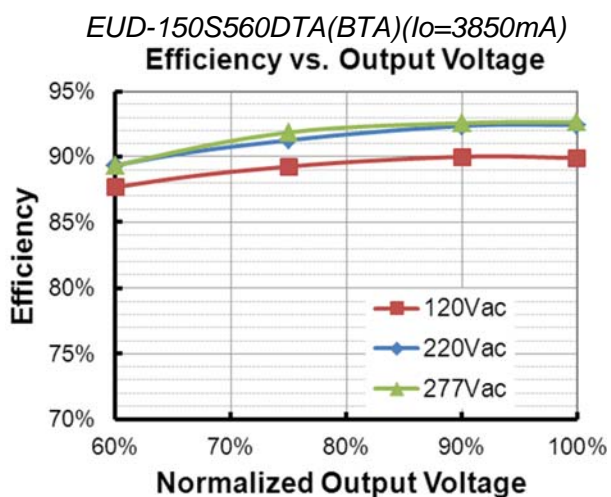
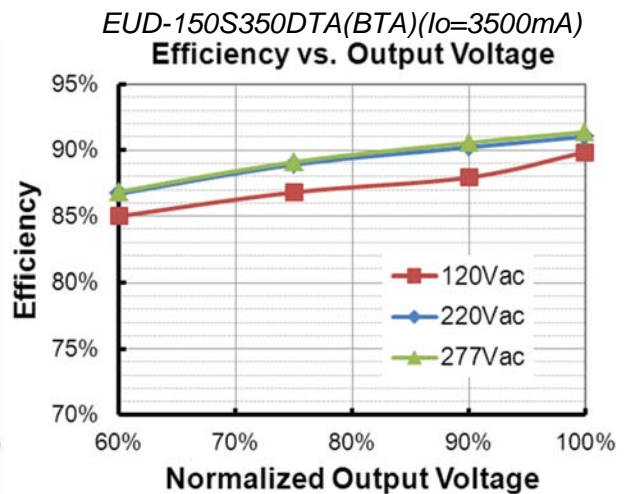
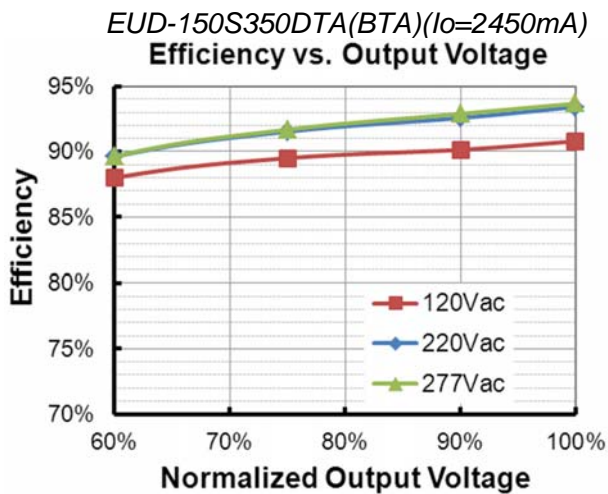
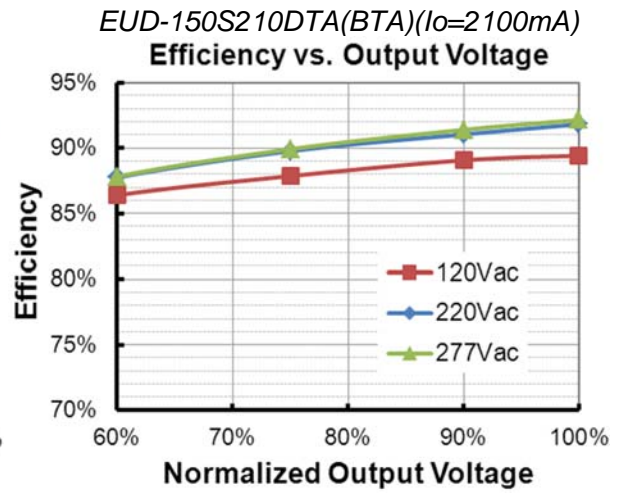
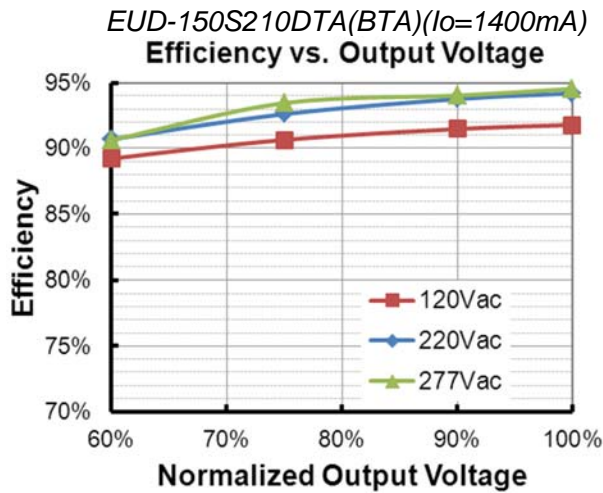

Power Factor

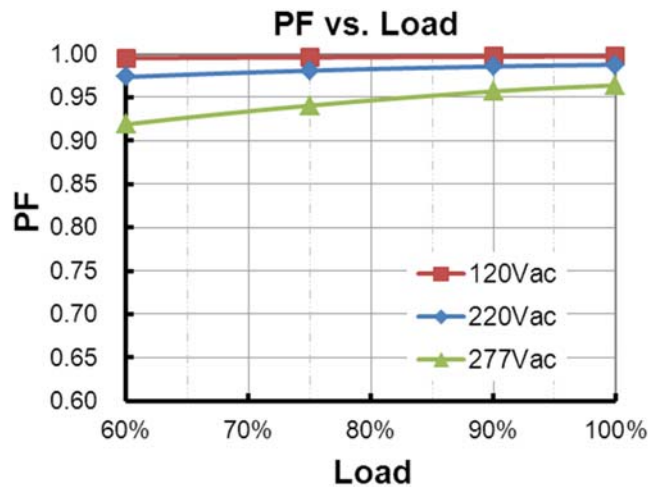

Total Harmonic Distortion

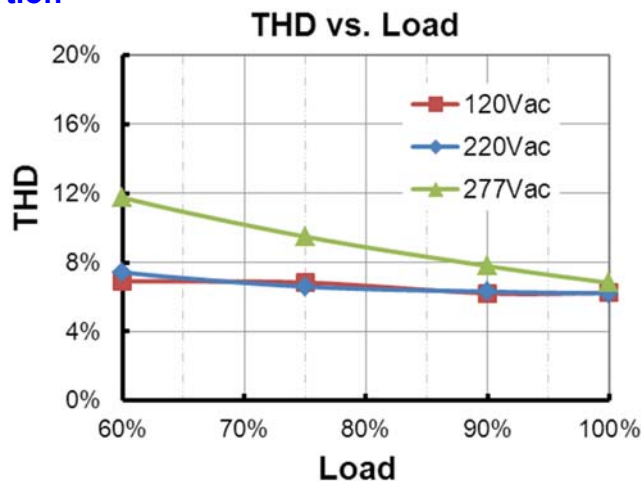

Protection Functions

Parameter		Min.	Typ.	Max.	Notes
External Thermal Protection NTC	R1	-	7.81 kOhm	-	When R_NTC falls below R1, External Thermal Protection is triggered, reducing output current until R2 is reached.
	R2	-	4.16 kOhm	-	When R_NTC is less than R2, output current is reduced to the programmed "Protection Current Floor."
	Protection Current Floor	10%loset	60%loset	100%loset	10%loset > Iomin (default setting is 60%)
		Iomin	60%loset	100%loset	10%loset ≤ Iomin (default setting is 60%)
Over Temperature Protection		Decreases output current, returning to normal after over temperature is removed.			
Short Circuit Protection		Auto Recovery. No damage will occur when any output is short circuited. The output shall return to normal when the fault condition is removed.			
Over Voltage Protection		Limits output voltage at no load and in case the normal voltage limit fails.			

Dimming

● 0-10V Dimming (Only DTA models)

The recommended implementation of the dimming control is provided below.

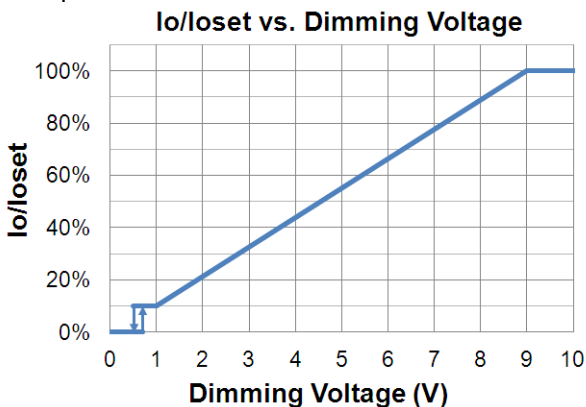
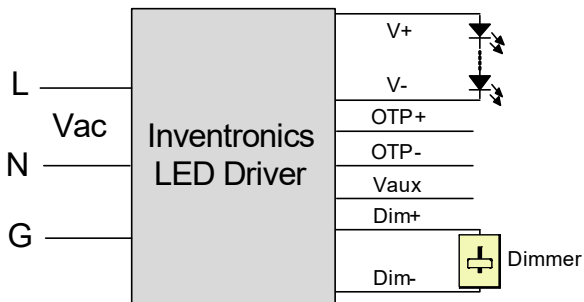

Implementation 1: DC Input

Notes:

1. Do NOT connect Dim- to the output V- or V+, otherwise the driver will not work properly.
2. The dimmer can also be replaced by an active 0-10V voltage source signal or passive components like zener.

● PWM Dimming (Only DTA models)

The recommended implementation of the dimming control is provided below.

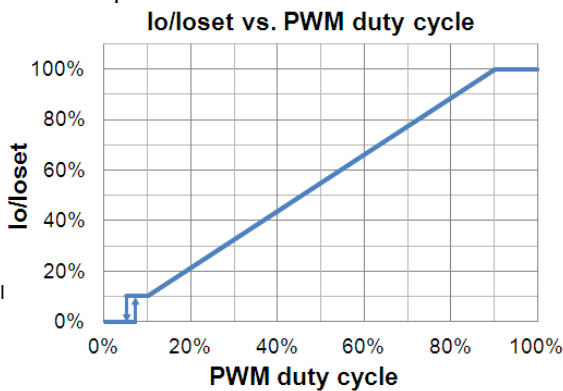
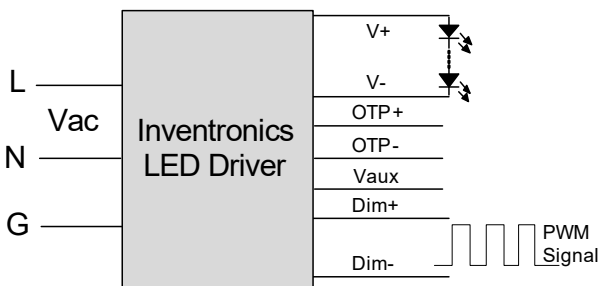

Implementation 2: Positive logic

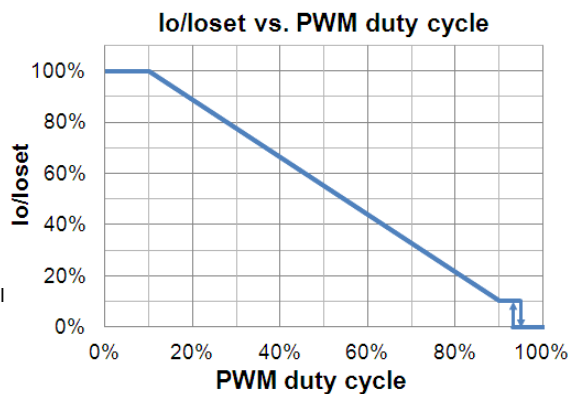
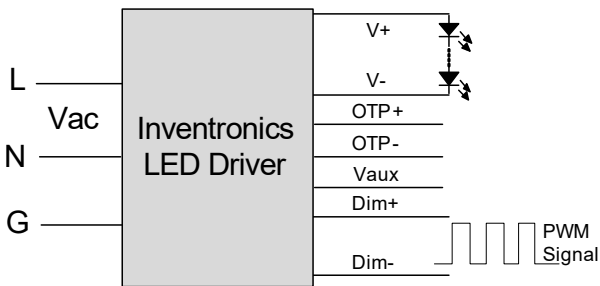

Implementation 3: Negative logic

Notes:

1. Do NOT connect Dim- to the output V- or V+, otherwise the driver will not work properly.
2. When PWM negative logic dimming mode and Dim+ is open, the driver will dim to off and be standby.

● **Time Dimming (Only DTA models)**

Time dimming control includes 3 kinds of modes, they are Self Adapting-Midnight, Self Adapting-Percentage and Traditional Timer.

- **Self Adapting-Midnight:** Automatically adjusts the dimming curve based on the on-time of past two days (if difference <15 minutes), assuming that the center point of the dimming curve is midnight local time.
- **Self Adapting-Percentage:** Automatically adjusts the on-time of each step by a constant percentage = (actual on-time for the past 2 days if difference <15 min) / (programmed on-time from the dimming curve).
- **Traditional Timer:** Follows the programmed timing curve after power on with no changes.

● **Output Lumen Compensation (Only DTA models)**

Output Lumen Compensation (OLC) may be used to maintain constant light output over the life of the LEDs by driving them at a reduced current when new, then gradually increasing the drive current over time to counteract LED lumen degradation.

● **DALI Dimming (Only BTA models)**

The recommended implementation of the dimming control is provided below.

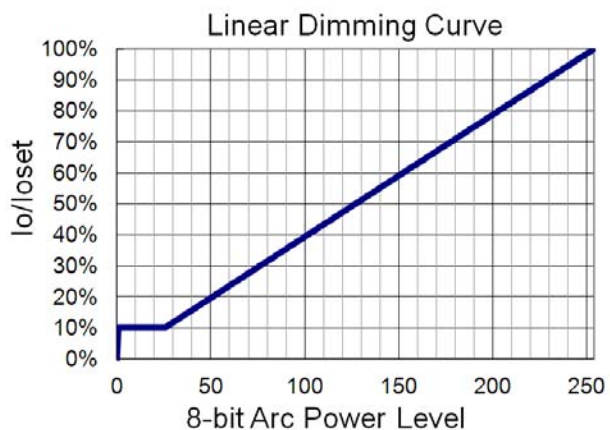
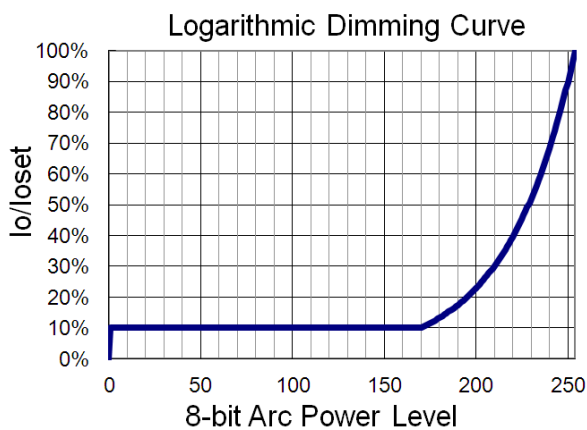
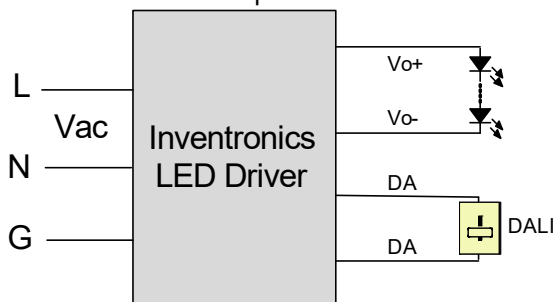

Implementation 4: DALI Dimming

Programming Connection Diagram

EUD-150SxxxDTA

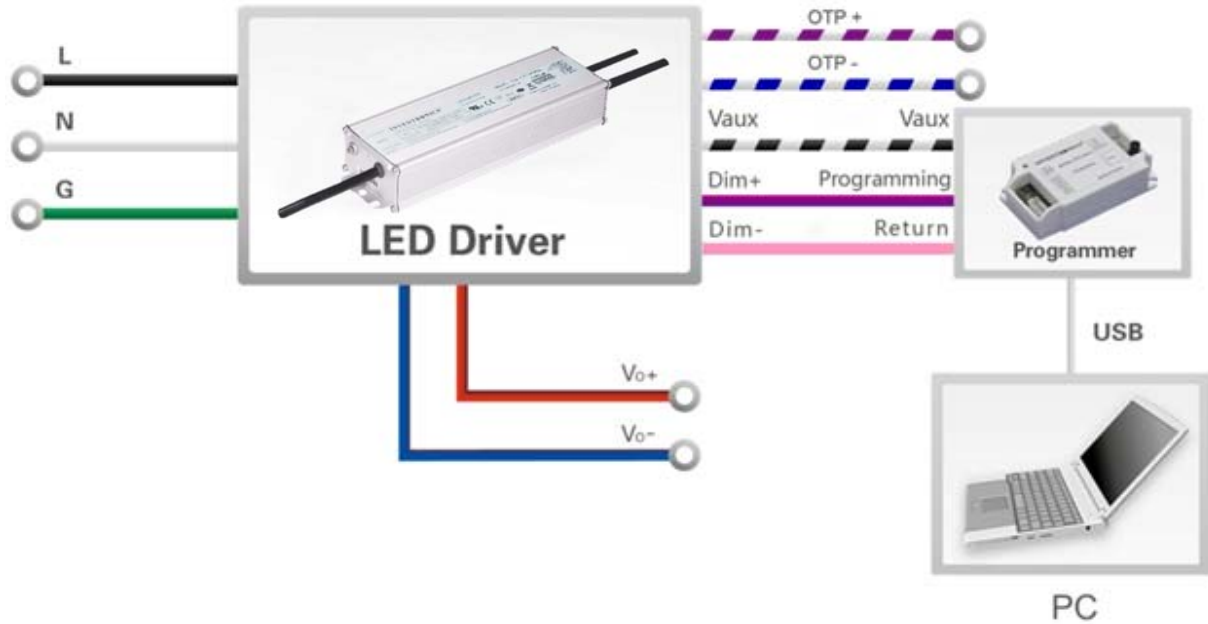

Note: The driver does not need to be powered on during the programming process.

EUD-150SxxxBTA

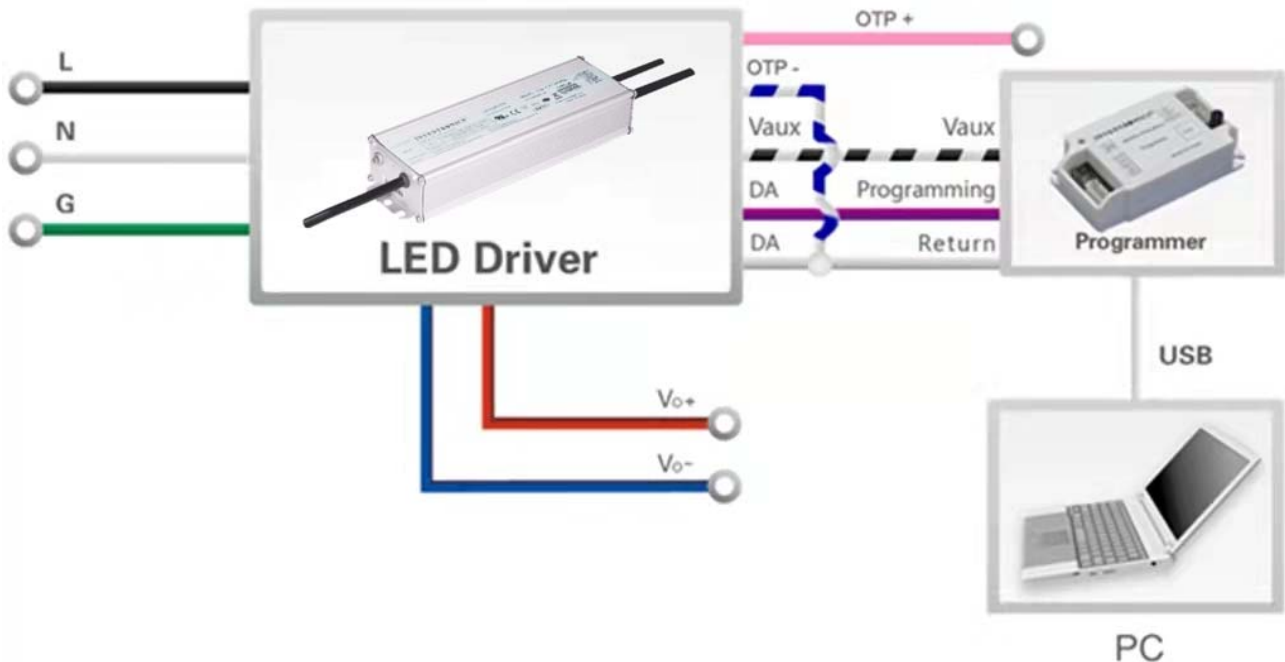

Note: (1) The driver does not need to be powered on during the programming process.

(2) Both "OTP-" and "DA" (gray) should be connected to "Return" of the programmer when programming.

● Please refer to [PRG-MUL2](#) (Programmer) datasheet for details.

Mechanical Outline

EUD-150SxxxDTA

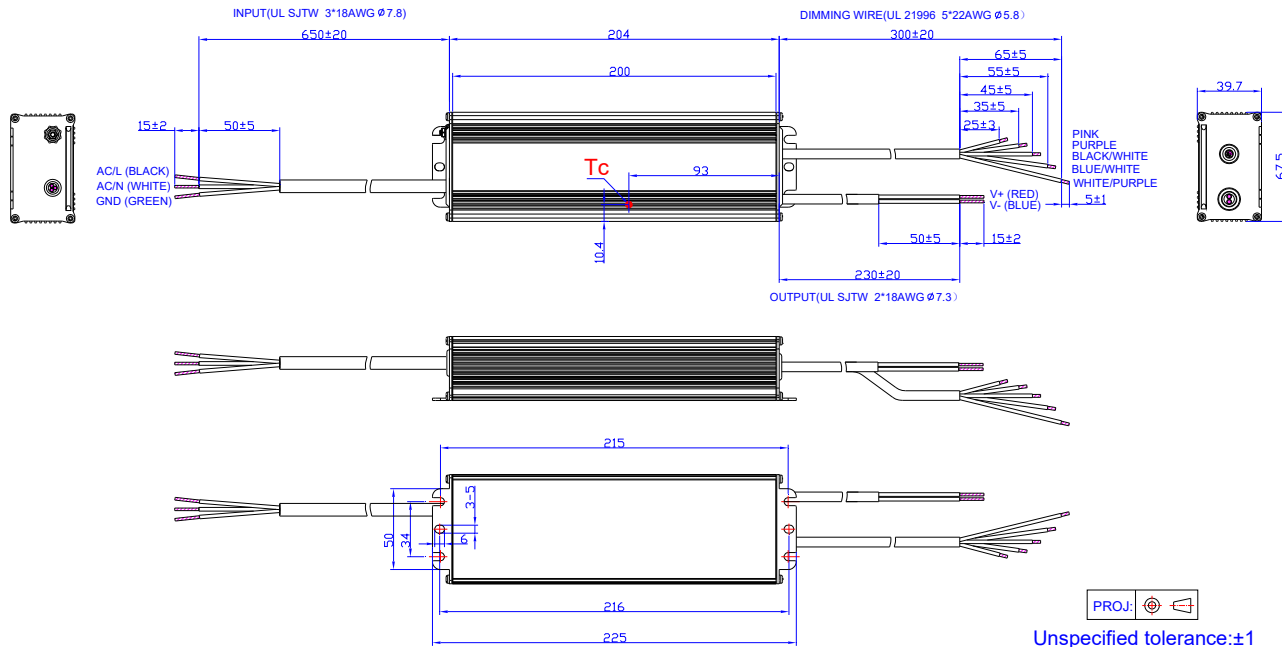

EUD-150SxxxBTA

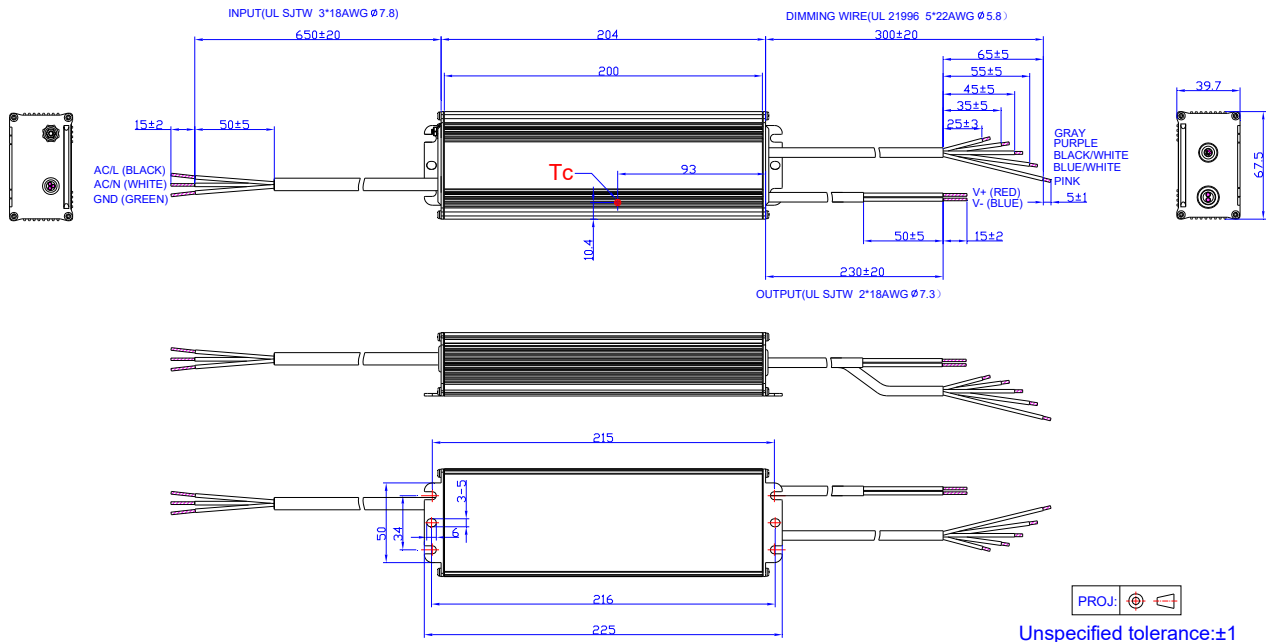

RoHS Compliance

Our products comply with reference to RoHS Directive (EU) 2015/863 amending 2011/65/EU, calling for the elimination of lead and other hazardous substances from electronic products.

Revision History

Change Date	Rev.	Description of Change		
		Item	From	To
2018-09-26	A	Datasheets Release	/	/
2018-11-13	B	12V Auxiliary Output Source Current	Notes	Updated
		Programming Connection Diagram	EUD-150SxxxBTA	Updated
2022-02-25	C	Product Photograph	/	Updated
		Features	/	Updated
		Programming Connection Diagram	/	Updated
		Mechanical Outline	/	Updated