

## Features

- Ultra High Efficiency (Up to 93.5%)
- Programmable Constant-Current Output
- DALI Dimmable and Dim-to-Off
- Standby Power  $\leq 1$  W
- Input Surge Protection: 4kV line-line, 6kV line-earth
- All-Around Protection: OVP, SCP, OTP
- Waterproof (IP67) and UL Dry / Damp Location
- SELV Output
- TYPE HL, for use in a Class I, Division 2 hazardous (Classified) location



## Description

The EUD-200SxxxBT series is a 200W, constant-current, programmable LED driver that operates from 90-305 Vac input with excellent power factor. Created for high bay, high mast, arena and roadway lights, it provides a dim-to-off mode with low standby power. The high efficiency of these drivers and compact metal case enables them to run cooler, significantly improving reliability and extending product life. To ensure trouble-free operation, protection is provided against input surge, output over voltage, short circuit, and over temperature.

## Models

Max. Output Current	Input Voltage Range(1)	Output Voltage Range	Max. Output Power	Typical Efficiency (2)	Power Factor		Model Number (3)
					120Vac	220Vac	
700 mA	90 ~ 305 Vac 127~300 Vdc	143~286Vdc	200 W	93.5%	0.99	0.96	EUD-200S070BT
1050 mA	90 ~ 305 Vac 127~300 Vdc	95~190Vdc	200 W	93.5%	0.99	0.96	EUD-200S105BT
1400 mA	90 ~ 305 Vac 127~300 Vdc	71~142Vdc	200 W	93.0%	0.99	0.96	EUD-200S140BT
2100 mA	90 ~ 305 Vac 127~300 Vdc	47~ 95 Vdc	200 W	93.0%	0.99	0.96	EUD-200S210BT <sup>(4)</sup>
2450 mA	90 ~ 305 Vac 127~300 Vdc	41~ 82 Vdc	200 W	93.5%	0.99	0.96	EUD-200S245BT <sup>(4)</sup>
2800 mA	90 ~ 305 Vac 127~300 Vdc	35~ 71 Vdc	200 W	92.5%	0.99	0.96	EUD-200S280BT <sup>(4)</sup>
4200 mA	90 ~ 305 Vac 127~300 Vdc	24~ 48 Vdc	200 W	93.0%	0.99	0.96	EUD-200S420BT <sup>(4)</sup>
4900 mA	90 ~ 305 Vac 127~300 Vdc	21~ 41 Vdc	200 W	92.0%	0.99	0.96	EUD-200S490BT <sup>(4)</sup>

**Notes:** (1) UL, FCC certified input voltage range: 100-277Vac or 127-300Vdc; other certified input voltage range except UL & FCC: 100-240Vac or 127-250Vdc

(2) Measured at full load and 220 Vac input.

(3) All the models are certificated to KS, except EUD-200S070BT

(4) SELV output

## Input Specifications

Parameter	Min.	Typ.	Max.	Notes
Input Voltage	90 Vac	-	305 Vac	127~300 Vdc
Input Frequency	47 Hz	-	63 Hz	
Leakage Current	-	-	0.75 MIU	UL8750; 277Vac/ 60Hz, grounding effectively
	-	-	0.70 mA	IEC60598-1; 240Vac/ 60Hz, grounding effectively
Input AC Current	-	-	2.4 A	Measured at full load and 100 Vac input.
	-	-	1.2 A	Measured at full load and 220 Vac input.
Inrush Current(I <sup>2</sup> t)	-	-	3.2 A <sup>2</sup> s	At 220Vac input, 25°C cold start, duration=1.7 ms, 10%Ipk-10%Ipk. See Inrush Current Waveform for the details.
PF	0.90	-	-	At 100-277Vac, 75%-100% Load (150-200W)
THD	-	-	20%	

## Output Specifications

Parameter	Min.	Typ.	Max.	Notes
Output Current Tolerance	-5%Iomax	-	5%Iomax	At full load condition
Output Current Setting(IoSet) Range	10%Iomax	-	100%Iomax	
Total Output Current Ripple (pk-pk)	-	5%Iomax	10%Iomax	At full load condition, 20 MHz BW
Output Current Ripple at < 200 Hz (pk-pk)	-	2%Iomax	-	At full load condition. Only this component of ripple is associated with visible flicker.
Startup Overshoot Current	-	-	10%Iomax	At full load condition
No Load Output Voltage				
EUD-200S070BT	-	-	305V	
EUD-200S105BT	-	-	205V	
EUD-200S140BT	-	-	155V	
EUD-200S210BT	-	-	110V	
EUD-200S245BT	-	-	95V	
EUD-200S280BT	-	-	80V	
EUD-200S420BT	-	-	55V	
EUD-200S490BT	-	-	48V	
Line Regulation	-	-	±0.5%	Measured at full load
Load Regulation	-	-	±1.5%	
Turn-on Delay Time	-	0.8 s	1.5 s	Measured at 120Vac and 220Vac input.
Temperature Coefficient of Iomax	-	-	0.03%/°C	Case temperature = 0°C ~Tc max

**Note:** All specifications are typical at 25 °C unless otherwise stated.

## General Specifications

Parameter	Min.	Typ.	Max.	Notes
Efficiency at 120 Vac input: EUD-200S070BT EUD-200S105BT EUD-200S140BT EUD-200S210BT EUD-200S245BT EUD-200S280BT EUD-200S420BT EUD-200S490BT	88.0% 88.0% 87.0% 87.0% 88.0% 86.0% 87.5% 87.0%	91.0% 91.0% 90.0% 90.0% 91.0% 89.0% 90.5% 90.0%	- - - - - - - -	Measured at full load and steady-state temperature in 25°C ambient; (Efficiency will be about 2.0% lower if measured immediately after startup.)
Efficiency at 220 Vac input: EUD-200S070BT EUD-200S105BT EUD-200S140BT EUD-200S210BT EUD-200S245BT EUD-200S280BT EUD-200S420BT EUD-200S490BT	91.5% 91.5% 91.0% 91.0% 91.5% 90.5% 91.0% 90.0%	93.5% 93.5% 93.0% 93.0% 93.5% 92.5% 93.0% 92.0%	- - - - - - - -	Measured at full load and steady-state temperature in 25°C ambient; (Efficiency will be about 2.0% lower if measured immediately after startup.)
Efficiency at 277 Vac input: EUD-200S070BT EUD-200S105BT EUD-200S140BT EUD-200S210BT EUD-200S245BT EUD-200S280BT EUD-200S420BT EUD-200S490BT	92.0% 91.5% 91.0% 91.0% 91.5% 91.0% 91.5% 90.5%	94.0% 93.5% 93.0% 93.0% 93.5% 93.0% 93.5% 92.5%	- - - - - - - -	Measured at full load and steady-state temperature in 25°C ambient; (Efficiency will be about 2.0% lower if measured immediately after startup.)
Standby power	-	-	1 W	Measured at 230Vac/50Hz; Dimming off
MTBF	-	341,000 Hours	-	Measured at 220Vac input, 80%Load and 25°C ambient temperature (MIL-HDBK-217F)
Lifetime	-	120,000 Hours	-	Measured at 220Vac input, 80%Load and 60°C case temperature; See lifetime vs. Tc curve for the details
Operating Case Temperature for Safety Tc_s	-40°C	-	+87°C	
Operating Case Temperature for Warranty Tc_w	-40°C	-	+70°C	
Storage Temperature	-40°C	-	+85°C	Humidity: 5%RH to 100%RH
Dimensions Inches (L × W × H) Millimeters (L × W × H)	8.82 × 2.66 × 1.56 224 × 67.5 × 39.5			With mounting ear 9.88 × 2.66 × 1.56 251 × 67.5 × 39.5
Net Weight	-	1200 g	-	

**Note:** All specifications are typical at 25 °C unless stated otherwise.

## Dimming Specifications

Parameter	Min.	Typ.	Max.	Notes
DA1, DA2 High Level	9.5V	16V	22.5V	
DA1, DA2 Low Level	-6.5V	0V	6.5V	
DA1, DA2 Current	0mA	-	2mA	
Dimming Output Range	10%Iomax	-	100%Ioset	10%Iomax ≤ Ioset ≤ 100%Iomax

## Standards Compliance

Safety Category	Standard
UL/CUL	UL8750, CAN/CSA-C22.2 No. 250.13
CE	EN 61347-1, EN61347-2-13
KS	KS C 7655
EMI standards	Notes
EN 55015 <sup>(1)</sup>	Conducted emission Test & Radiated emission Test
EN 61000-3-2	Harmonic current emissions
EN 61000-3-3	Voltage fluctuations & flicker
FCC Part 15 <sup>(1)</sup>	ANSI C63.4 Class B This device complies with Part 15 of the FCC Rules. Operation is subject to the following two conditions: [1] this device may not cause harmful interference, and [2] this device must accept any interference received, including interference that may cause undesired Operation.
EMS standards	Notes
EN 61000-4-2	Electrostatic Discharge (ESD): 8 kV air discharge, 4 kV contact discharge
EN 61000-4-3	Radio-Frequency Electromagnetic Field Susceptibility Test-RS
EN 61000-4-4	Electrical Fast Transient / Burst-EFT
EN 61000-4-5	Surge Immunity Test: AC Power Line: line to line 4 kV, line to earth 6 kV <sup>(2)</sup>
EN 61000-4-6	Conducted Radio Frequency Disturbances Test-CS
EN 61000-4-8	Power Frequency Magnetic Field Test
EN 61000-4-11	Voltage Dips
EN 61547	Electromagnetic Immunity Requirements Applies To Lighting Equipment
DALI Standards	Notes
DALI	IEC62386-101,102 & part of 207 <sup>(3)</sup>

**Note:** (1) This LED driver meets the EMI specifications above, but EMI performance of a luminaire that contains it depends also on the other devices connected to the driver and on the fixture itself.

- (2) To perform electric strength (hi-pot) testing, the “GDT ground disconnect” (nut and metal lock sheet) on the driver end-cap should be removed temporarily to prevent the internal gas discharge tube from conducting (as allowed by IEC 60598-1 Clause 10.2). After testing is completed, these items must be reinstalled to restore line-to-earth surge protection and secure the end cap.
- (3) Optional Commands Implemented: 242 (query short circuit), 243 (query open circuit)

## Lifetime vs. Case Temperature

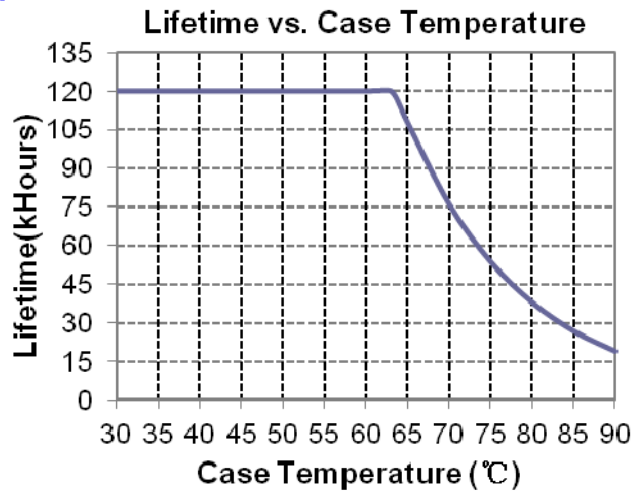

## Inrush Current Waveform

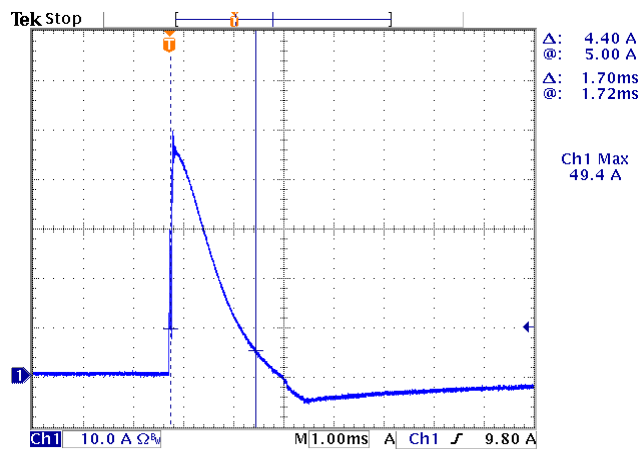

## Efficiency vs. Load

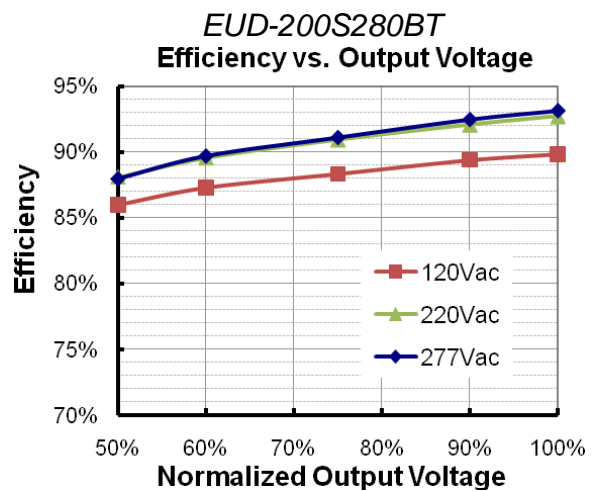
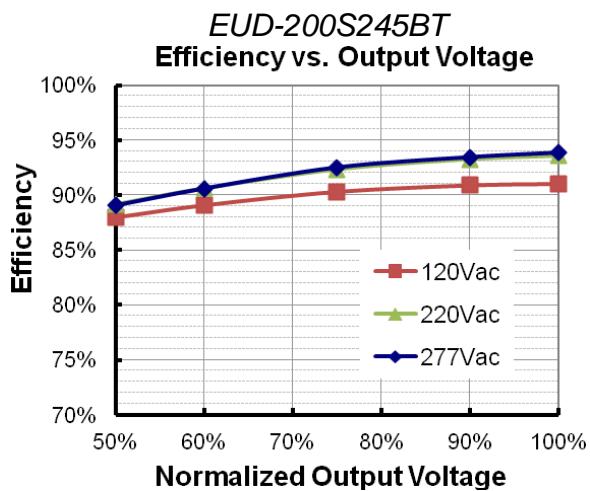
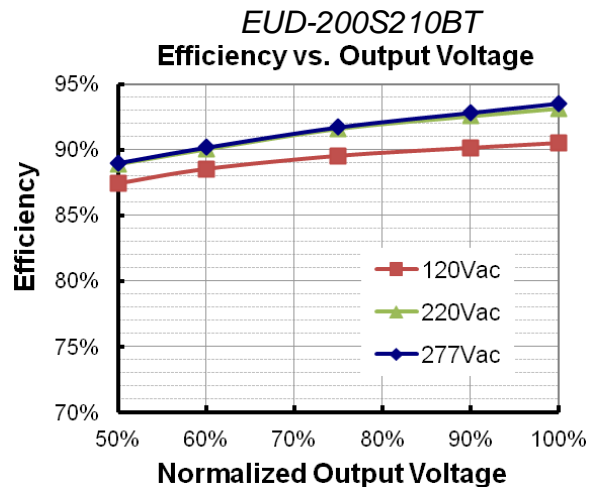
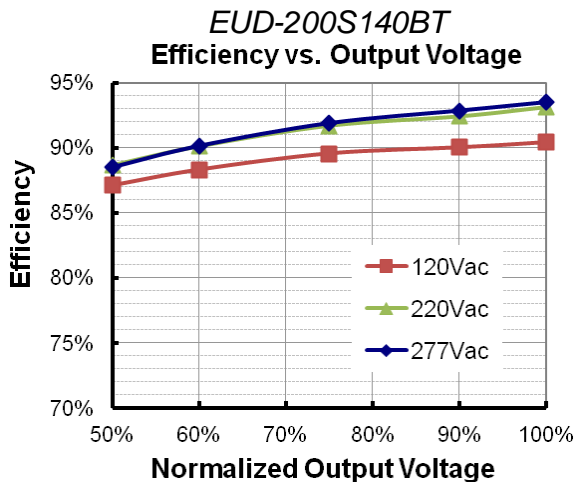
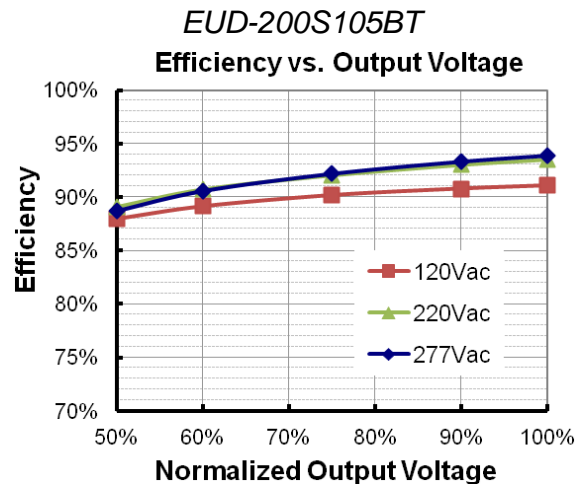
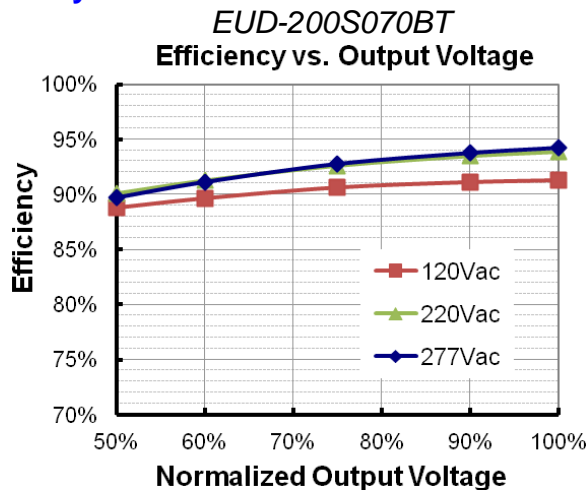

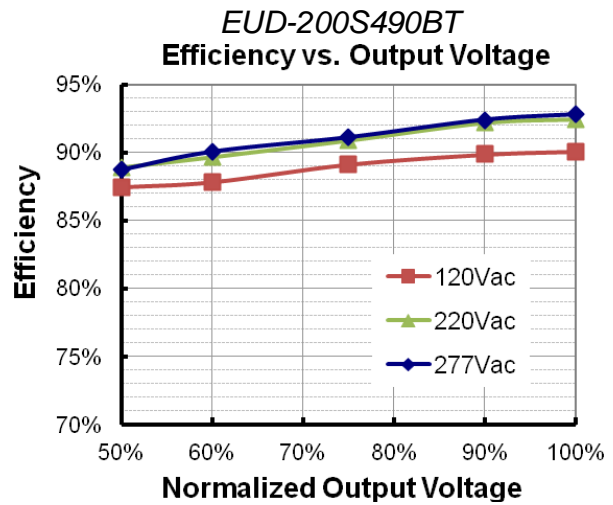
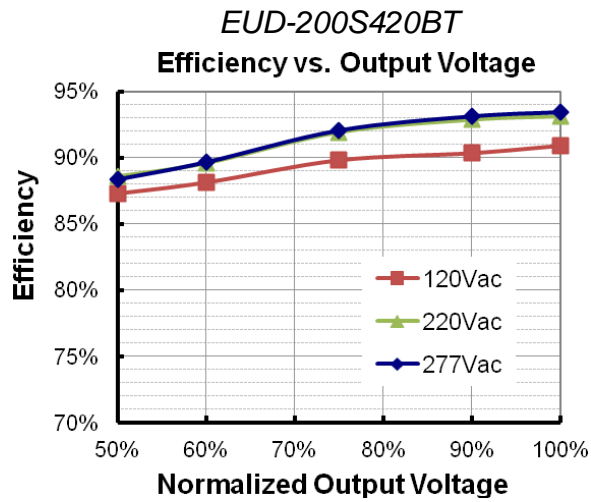

## Power Factor

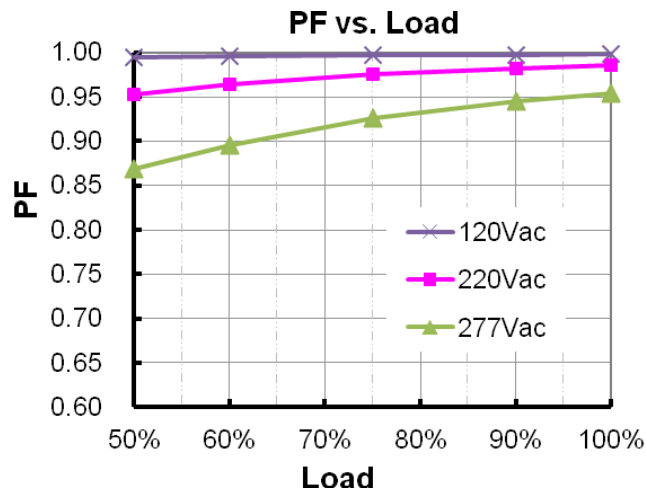

## Total Harmonic Distortion

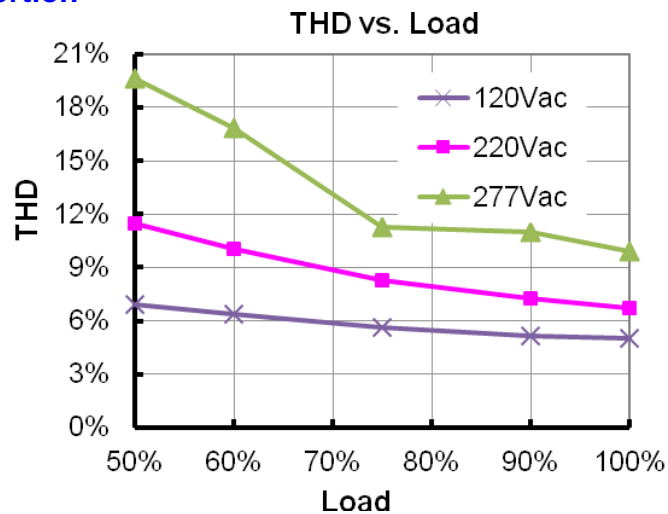



## Protection Functions

Parameter	Notes
Over Temperature Protection	Decreases output current, returning to normal after over temperature is removed.
Short Circuit Protection	Auto Recovery. No damage will occur when any output is short circuited. The output shall return to normal when the fault condition is removed.
Over Voltage Protection	Limits output voltage at no load and in case the normal voltage limit fails.

## Dimming

### ● DALI Dimming

The recommended implementation of the dimming control is provided below.

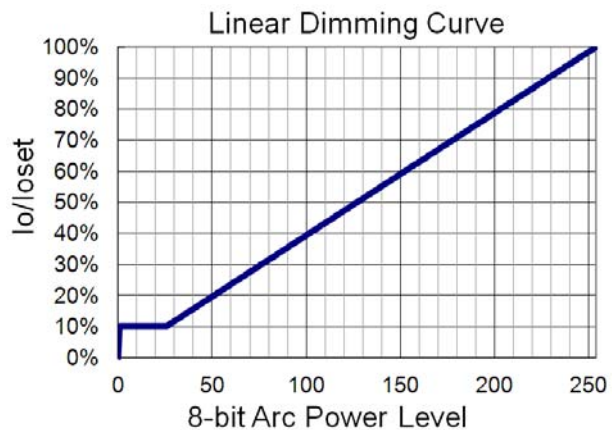
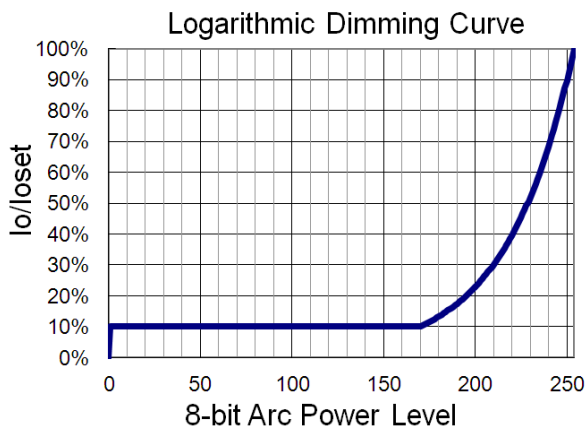
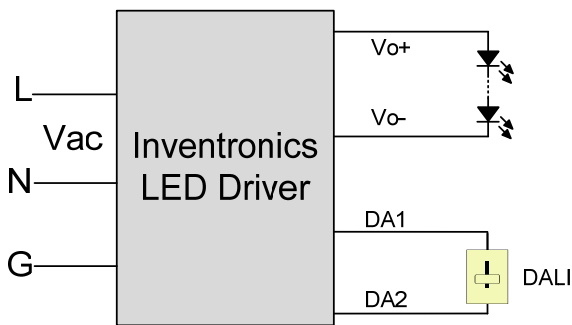

Implementation: DALI Dimming



## Programming Connection Diagram

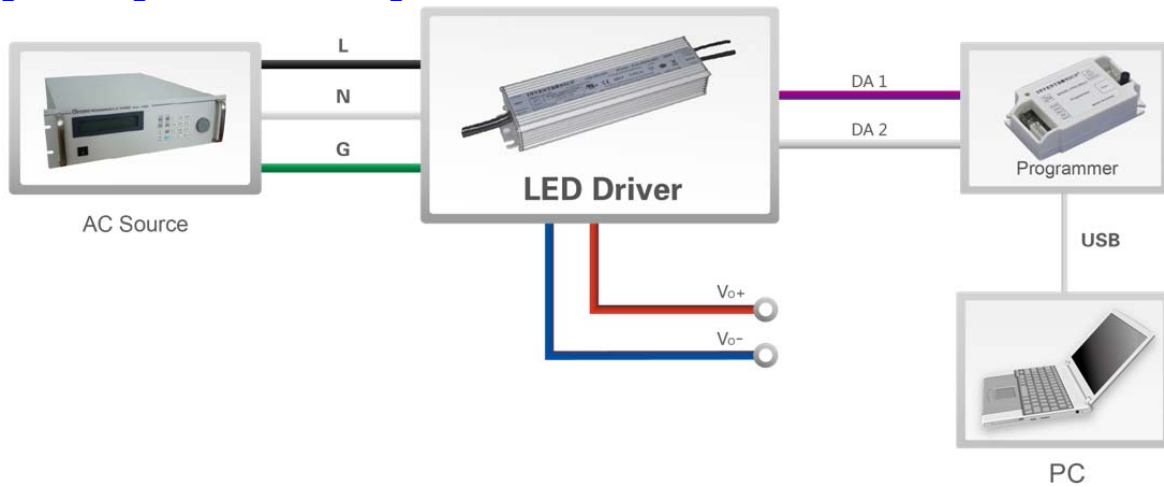

**Note:** The driver needs to be powered on during the programming process.

- Please refer to [PRG-MUL2 Multi-Programmer datasheet](#) for details.

## Mechanical Outline

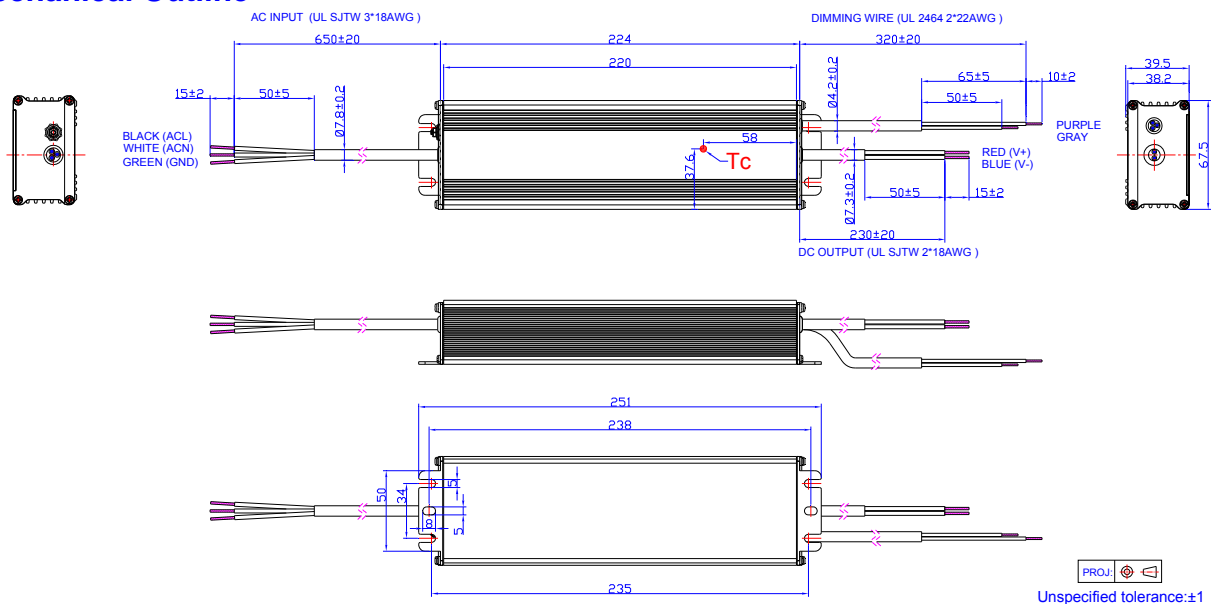

## RoHS Compliance

Our products comply with the European Directive 2011/65/EC, calling for the elimination of lead and other hazardous substances from electronic products.

## Revision History

Change Date	Rev.	Description of Change		
		Item	From	To
2013-08-16	A	Datasheets Release	/	/
2014-07-23	B	Dimming control- EUD-200SxxxBT	/	Added
		PF curve	/	Updated
		THD curve	/	Updated
		Model 4200mA and Model 4900mA	/	Added
		Efficiency of all models	/	Updated
		Mechanical Outline	/	Updated
2014-10-10	C	Case Temperature	/	Updated
		Dimming Output Range	/	Added
		Output Current Setting(Ioset) Range	/	Added
2015-03-11	D	Features	Input Surge Protection: 4kV line-line, 6kV line-earth	Added
		Output Current Ripple(pk-pk)	Output Current Ripple(pk-pk)	Total Output Current Ripple (pk-pk)
		Output Current Ripple at < 200 Hz (pk-pk)	/	Added
		Case Temperature	Case Temperature	Operating Case Temperature for Safety Tc_s
		Operating Case Temperature for Warranty Tc_w	/	Added
		General Specifications	Storage Temperature	Added
		Environmental Specifications	/	Delete
		Safety & EMC Compliance	EN 55015 EN 61000-3-2 EN 61000-3-3	Delete
Derating	/	Delete		
2015-09-16	E	KS, DALI Logo	/	Added
		Features	/	Updated
		Safety & EMC Compliance	Safety & EMC Compliance	Standards Compliance
		Standards Compliance	DALI Standards	Added
		DALI Dimming	/	Updated
2015-12-03	F	CE	/	Added
		External Grounding Screw Solution	/	/
		Standards Compliance	/	Updated
		Mechanical Outline	/	Updated

## Revision History (Continued)

Change Date	Rev.	Description of Change		
		Item	From	To
2016-03-31	G	General Specifications	With mounting ear	Updated
		Safety & EMC Compliance	/	Updated
2017-03-01	H	Inrush Current(I <sup>2</sup> t)	/	Updated
		Mechanical Outline	/	Updated
2019-08-22	I	Safety & EMC Compliance	UL/CUL	Updated
		Safety & EMC Compliance	KS	Updated
		Safety & EMC Compliance	FCC	Updated