

## Features

- Ultra High Efficiency (Up to 94.5%)
- Full Power at Wide Output Current Range (Constant Power)
- Thermal Sensing and Protection for LED Module
- DALI/3-Timer-Modes Dimmable
- Dim-to-Off with Standby Power  $\leq 0.5$  W
- Always-on Auxiliary Power: 12Vdc, 200mA (Transient Peak Current up to 400mA)
- Output Lumen Compensation
- Input Surge Protection: DM 6kV, CM 10kV
- All-Around Protection: OVP, SCP, OTP
- IP67
- SELV Output
- 7 Years Warranty



## Description

The EUD-200SxxxBVA series is a 200W, constant-current, programmable LED driver that operates from 90-305 Vac input with excellent power factor. Created for many lighting applications including high bay, high mast, arena and roadway, etc, it provides a dim-to-off mode with low standby power. The high efficiency of these drivers and compact metal case enables them to run cooler, significantly improving reliability and extending product life. To ensure trouble-free operation, protection is provided against input surge, output over voltage, short circuit, and over temperature.

## Models

Adjustable Output Current Range	Full-Power Current Range (1)	Default Output Current	Input Voltage Range(2)	Output Voltage Range	Max. Output Power	Typical Efficiency (3)	Power Factor		Model Number (6) (7)
							120Vac	220Vac	
70-1050mA	700-1050mA	700 mA	90~305 Vac/ 100~250 Vdc	95~286Vdc	200W	94.5%	0.99	0.96	EUD-200S105BVA <sup>(4)</sup>
140-2100mA	1400-2100mA	1400 mA	90~305 Vac/ 100~250 Vdc	48~143Vdc	200W	94.0%	0.99	0.96	EUD-200S210BVA <sup>(4)</sup>
245-3500mA	2450-3500mA	2800 mA	90~305 Vac/ 100~250 Vdc	29 ~ 82Vdc	200W	93.5%	0.99	0.96	EUD-200S350BVA <sup>(5)</sup>
385-5600mA	3850-5600mA	4900 mA	90~305 Vac/ 100~250 Vdc	18 ~ 52Vdc	200W	93.0%	0.99	0.96	EUD-200S560BVA <sup>(5)</sup>

- Notes:** (1) Output current range with constant power at 200W.  
 (2) Certified voltage range: 100-240Vac or 100~250 (except CCC, PSE and KS).  
 (3) Measured at 100% load and 220Vac input (see below "General Specifications" for details).  
 (4) Certificated to Global-mark.  
 (5) SELV output.  
 (6) All the models are certificated to KS, except EUD-200S105BVA.  
 (7) For BIS models add suffix -3000.

## I-V Operation Area

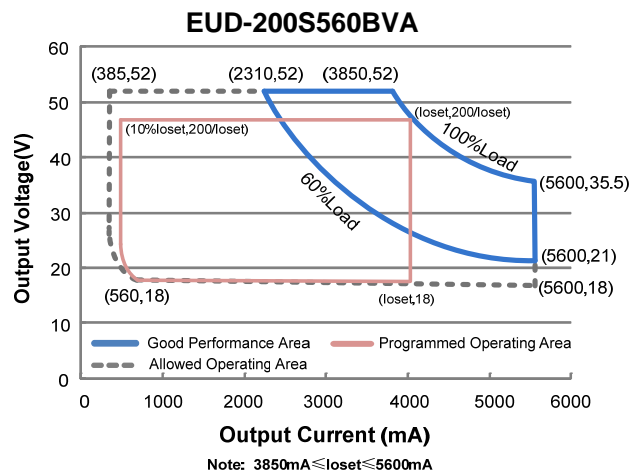
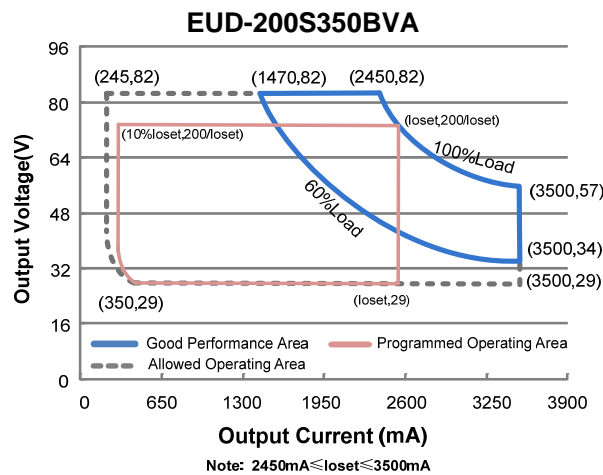
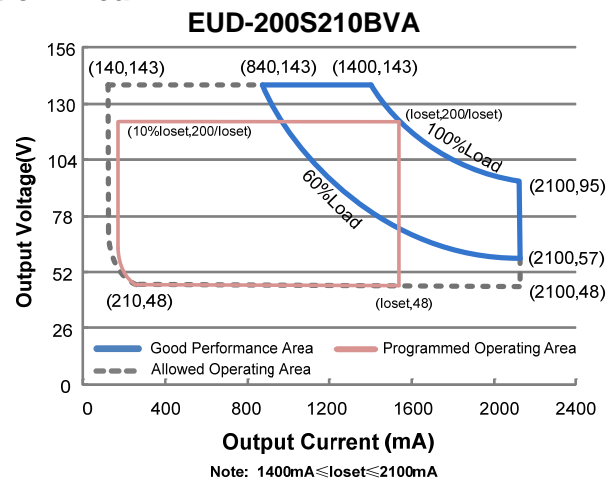
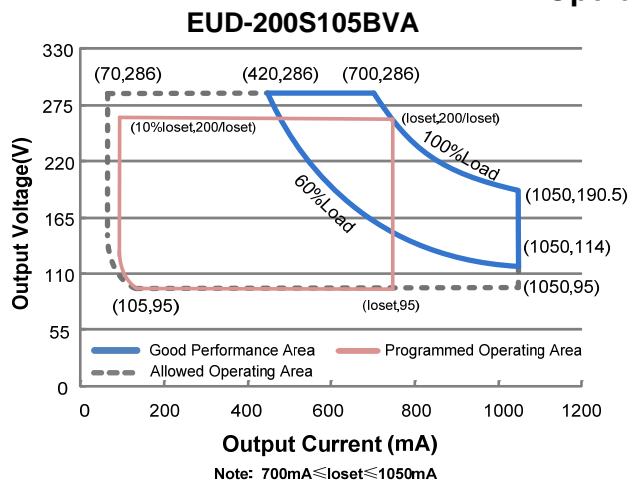

## Input Specifications

Parameter	Min.	Typ.	Max.	Notes
Input Voltage	90 Vac	-	305 Vac	100~250Vdc
Input Frequency	47 Hz	-	63 Hz	
Leakage Current	-	-	0.70 mA	IEC60598-1; 240Vac/ 60Hz
Input AC Current	-	-	2.50 A	Measured at 100% load and 100 Vac input.
	-	-	1.10 A	Measured at 100% load and 220 Vac input.
Inrush Current( $I^2t$ )	-	-	2.90 A <sup>2</sup> s	At 220Vac input, 25°C cold start, duration=1.20 ms, 10%Ipk-10%Ipk. See Inrush Current Waveform for the details.
PF	0.90	-	-	At 100-240Vac, 50-60Hz, 60%-100% Load (120-200W)
THD	-	-	20%	
THD	-	-	10%	At 220-240Vac, 50-60Hz, 75%-100% Load (150-200W)

## Output Specifications

Parameter	Min.	Typ.	Max.	Notes
Output Current Tolerance	-5%loset	-	5%loset	At 100% load condition
Output Current Setting(loset) Range				
EUD-200S105BVA	70 mA	-	1050 mA	
EUD-200S210BVA	140 mA	-	2100 mA	
EUD-200S350BVA	245 mA	-	3500 mA	
EUD-200S560BVA	385 mA	-	5600 mA	
Output Current Setting Range with Constant Power				
EUD-200S105BVA	700 mA	-	1050 mA	
EUD-200S210BVA	1400 mA	-	2100 mA	
EUD-200S350BVA	2450 mA	-	3500 mA	
EUD-200S560BVA	3850 mA	-	5600 mA	
Total Output Current Ripple (pk-pk)	-	5%lomag	10%lomag	At 100% load condition, 20 MHz BW
Output Current Ripple at < 200 Hz (pk-pk)	-	2%lomag	-	At 100% load condition. Only this component of ripple is associated with visible flicker.
Startup Overshoot Current	-	-	10%lomag	At 100% load condition
No Load Output Voltage				
EUD-200S105BVA	-	-	330 V	
EUD-200S210BVA	-	-	170 V	
EUD-200S350BVA	-	-	100 V	
EUD-200S560BVA	-	-	60 V	
Line Regulation	-	-	±0.5%	Measured at 100% load
Load Regulation	-	-	±1.5%	
Turn-on Delay Time	-	-	1.0 s	Measured at 120Vac input, 60%-100% Load.
	-	-	0.5 s	Measured at 220Vac input, 60%-100% Load.
Temperature Coefficient of loset	-	0.03%/°C	-	Case temperature = 0°C ~Tc max
12V Auxiliary Output Voltage	10.8 V	12 V	13.2 V	
12V Auxiliary Output Source Current	0 mA	-	200 mA	Return terminal is "OTP"
12V Auxiliary Output Transient Peak Current	-	-	400 mA	400mA peak for a maximum duration of 300ms in a 2s period during which time the average should not exceed 200mA.

## General Specifications

Parameter	Min.	Typ.	Max.	Notes
Efficiency at 120 Vac input: EUD-200S105BVA I <sub>o</sub> = 700mA I <sub>o</sub> =1050mA EUD-200S210BVA I <sub>o</sub> =1400mA I <sub>o</sub> =2100mA EUD-200S350BVA I <sub>o</sub> =2450mA I <sub>o</sub> =3500mA EUD-200S560BVA I <sub>o</sub> =3850mA I <sub>o</sub> =5600mA	89.5% 88.5% 89.0% 88.0% 89.0% 87.5% 88.5% 86.5%	91.5% 90.5% 91.0% 90.0% 91.0% 89.5% 90.5% 88.5%	- - - - - - - -	Measured at 100% load and steady-state temperature in 25°C ambient; (Efficiency will be about 2.0% lower if measured immediately after startup.)
Efficiency at 220 Vac input: EUD-200S105BVA I <sub>o</sub> = 700mA I <sub>o</sub> =1050mA EUD-200S210BVA I <sub>o</sub> =1400mA I <sub>o</sub> =2100mA EUD-200S350BVA I <sub>o</sub> =2450mA I <sub>o</sub> =3500mA EUD-200S560BVA I <sub>o</sub> =3850mA I <sub>o</sub> =5600mA	92.5% 91.0% 92.0% 91.0% 91.5% 90.0% 91.0% 88.5%	94.5% 93.0% 94.0% 93.0% 93.5% 92.0% 93.0% 90.5%	- - - - - - - -	Measured at 100% load and steady-state temperature in 25°C ambient; (Efficiency will be about 2.0% lower if measured immediately after startup.)
Efficiency at 277 Vac input: EUD-200S105BVA I <sub>o</sub> = 700mA I <sub>o</sub> =1050mA EUD-200S210BVA I <sub>o</sub> =1400mA I <sub>o</sub> =2100mA EUD-200S350BVA I <sub>o</sub> =2450mA I <sub>o</sub> =3500mA EUD-200S560BVA I <sub>o</sub> =3850mA I <sub>o</sub> =5600mA	92.5% 91.5% 92.5% 91.0% 92.0% 90.5% 91.5% 89.0%	94.5% 93.5% 94.5% 93.0% 94.0% 92.5% 93.5% 91.0%	- - - - - - - -	Measured at 100% load and steady-state temperature in 25°C ambient; (Efficiency will be about 2.0% lower if measured immediately after startup.)
Standby power	-	-	0.5 W	Measured at 230Vac/50Hz; Dimming off
MTBF	-	233,000 Hours	-	Measured at 220Vac input, 80%Load and 25°C ambient temperature (MIL-HDBK-217F)
Lifetime	-	108,000 Hours	-	Measured at 220Vac input, 80%Load and 70°C case temperature; See lifetime vs. T <sub>c</sub> curve for the details
Operating Case Temperature for Safety T <sub>c_s</sub>	-40°C	-	+89°C	
Operating Case Temperature for Warranty T <sub>c_w</sub>	-40°C	-	+75°C	Case temperature for 7 years warranty. Please see <i>Inventronics Warranty Statement</i> for complete details.
Storage Temperature	-40°C	-	+85°C	Humidity: 5%RH to 100%RH
Dimensions Inches (L × W × H) Millimeters (L × W × H)	8.27 × 2.66 × 1.56 210 × 67.5 × 39.5			With mounting ear 9.10 × 2.66 × 1.56 231 × 67.5 × 39.5
Net Weight	-	1200 g	-	

## Dimming Specifications

Parameter		Min.	Typ.	Max.	Notes
DA, DA High Level		9.5V	16V	22.5V	
DA, DA Low Level		-6.5V	0V	6.5V	
DA, DA Current		0mA	-	2mA	
Dimming Output Range	EUD-200S105BVA EUD-200S210BVA EUD-200S350BVA EUD-200S560BVA	10%loset	-	loset	700 mA ≤ loset ≤ 1050 mA 1400 mA ≤ loset ≤ 2100 mA 2450 mA ≤ loset ≤ 3500 mA 3850 mA ≤ loset ≤ 5600 mA
	EUD-200S105BVA EUD-200S210BVA EUD-200S350BVA EUD-200S560BVA	70 mA 140 mA 245 mA 385 mA	-	loset	70 mA ≤ loset < 700 mA 140 mA ≤ loset < 1400 mA 245 mA ≤ loset < 2450 mA 385 mA ≤ loset < 3850 mA

## Standards Compliance

Safety Category	Standard
ENEC & TUV & CE	EN 61347-1, EN 61347-2-13
CB	IEC 61347-1, IEC 61347-2-13
CCC	GB 19510.1, GB 19510.14
PSE	J 61347-1, J 61347-2-13
KS	KS C 7655
BIS	IS 15885(Part2/Sec13)
Global Mark	AS/NZS 61347.1, AS/NZS 61347.2.13
EMI Standards	Notes
EN 55015/GB 17743 <sup>(1)</sup>	Conducted emission Test & Radiated emission Test
EN 61000-3-2/GB 17625.1	Harmonic current emissions
EN 61000-3-3	Voltage fluctuations & flicker
EMS Standards	Notes
EN 61000-4-2	Electrostatic Discharge (ESD): 8 kV air discharge, 4 kV contact discharge
EN 61000-4-3	Radio-Frequency Electromagnetic Field Susceptibility Test-RS
EN 61000-4-4	Electrical Fast Transient / Burst-EFT
EN 61000-4-5	Surge Immunity Test: AC Power Line: Differential Mode 6 kV, Common Mode 10 kV <sup>(2)</sup>
EN 61000-4-6	Conducted Radio Frequency Disturbances Test-CS
EN 61000-4-8	Power Frequency Magnetic Field Test
EN 61000-4-11	Voltage Dips
EN 61547	Electromagnetic Immunity Requirements Applies To Lighting Equipment

## Standards Compliance (Continued)

DALI Standards	Notes
DALI	IEC62386-101,102 & part of 207 <sup>(3)</sup>

**Note:** (1) This LED driver meets the EMI specifications above, but EMI performance of a luminaire that contains it depends also on the other devices connected to the driver and on the fixture itself.

(2) To perform electric strength (hi-pot) testing, the “GDT ground disconnect” (nut and metal lock sheet) on the driver end-cap should be removed temporarily to prevent the internal gas discharge tube from conducting (as allowed by IEC 60598-1 Clause 10.2). After testing is completed, these items must be reinstalled to restore line-to-earth surge protection and secure the end cap.

(3) Optional Commands Implemented: 242 (query short circuit), 243 (query open circuit)

## Lifetime vs. Case Temperature

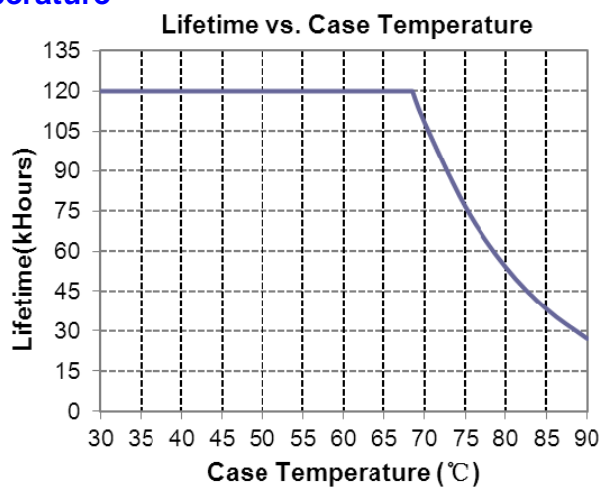

## Inrush Current Waveform

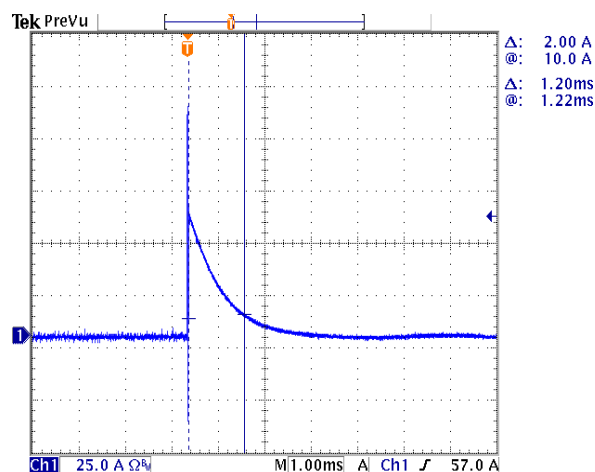

## Efficiency vs. Load

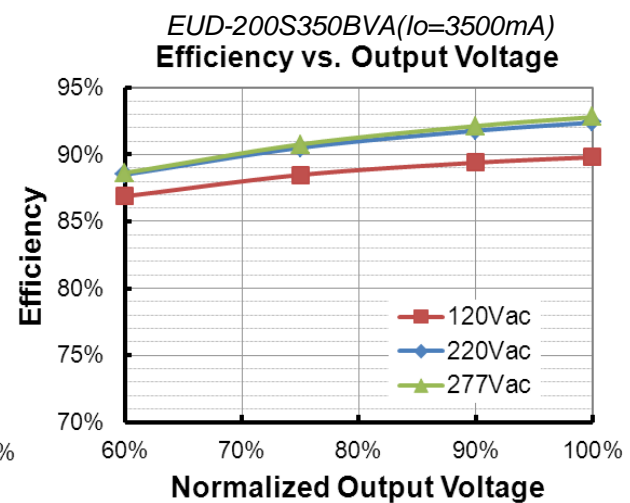
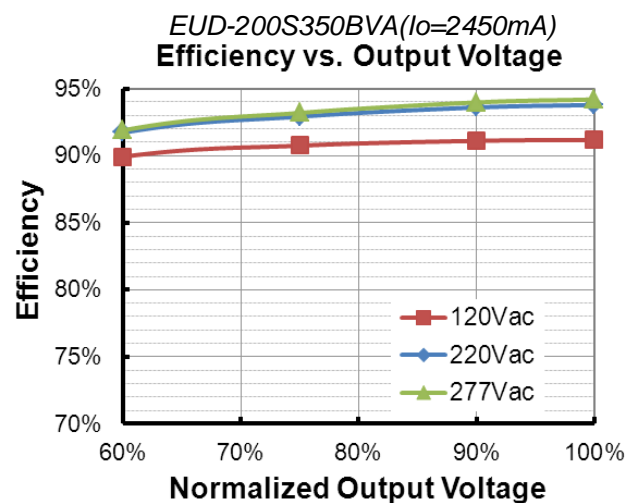
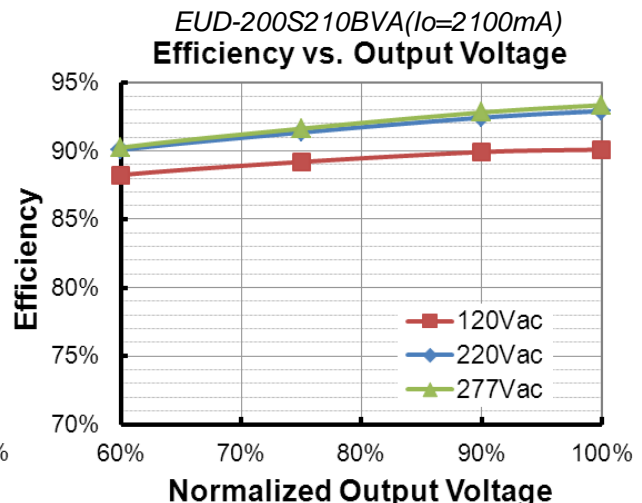
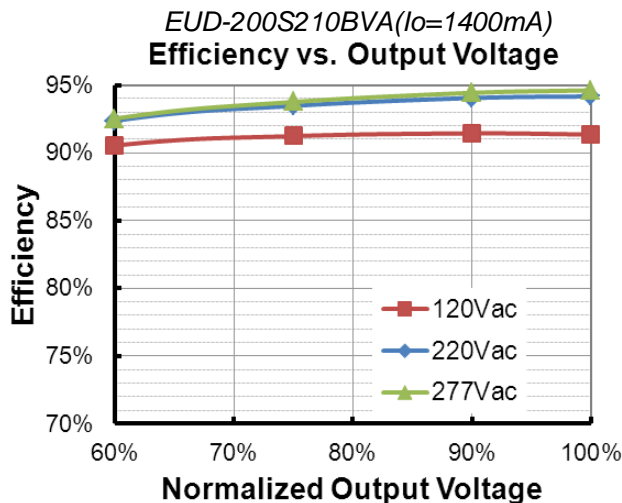
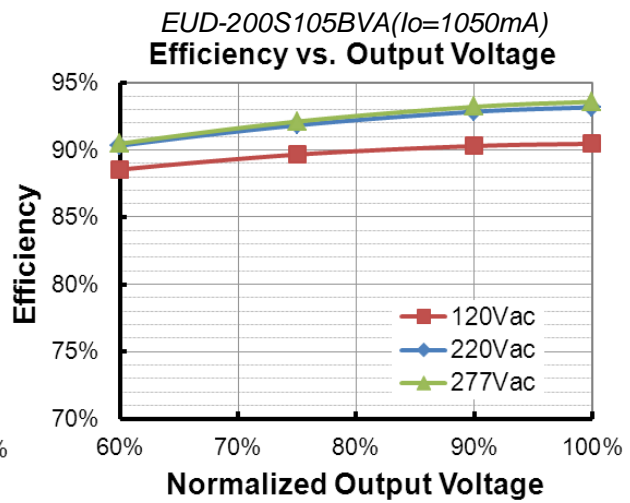
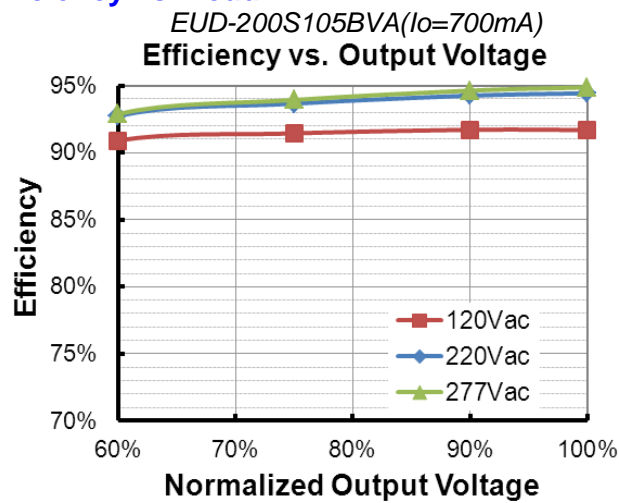

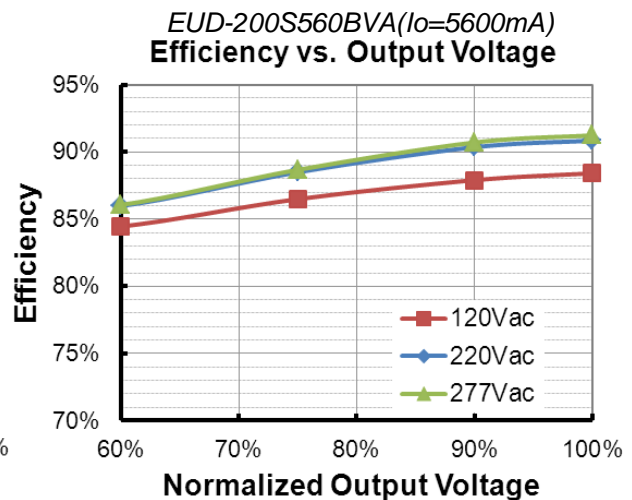
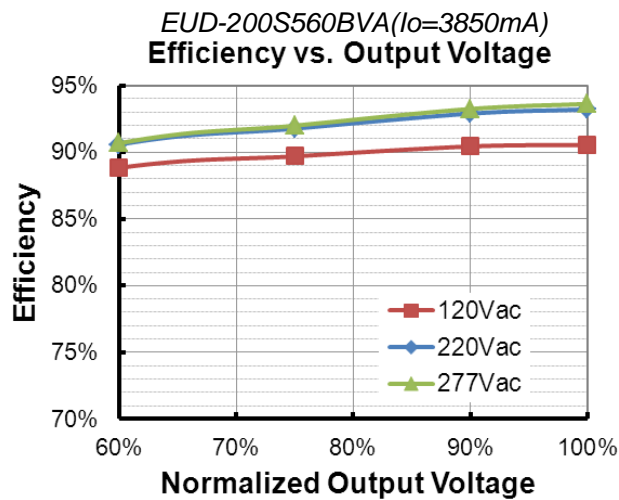

## Power Factor

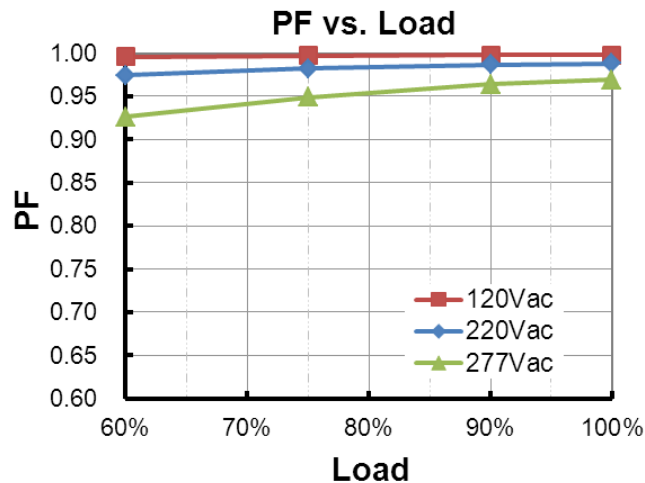

## Total Harmonic Distortion

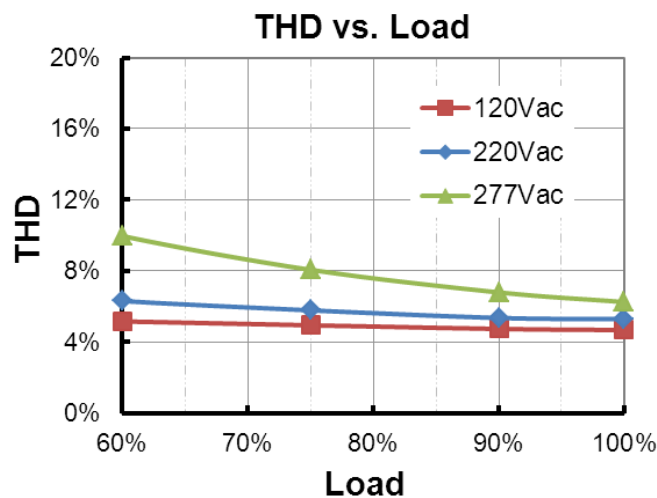



## Protection Functions

Parameter		Min.	Typ.	Max.	Notes
External Thermal Protection NTC	R1	-	7.81 kOhm	-	When R_NTC falls below R1, External Thermal Protection is triggered, reducing output current until R2 is reached.
	R2	-	4.16 kOhm	-	When R_NTC is less than R2, output current is reduced to the programmed "Protection Current Floor."
	Protection Current Floor	10%loset	60%loset	100%loset	10%loset > I <sub>omin</sub> (default setting is 60%)
I <sub>omin</sub>		60%loset	100%loset	10%loset ≤ I <sub>omin</sub> (default setting is 60%)	
Over Temperature Protection		Decreases output current, returning to normal after over temperature is removed.			
Short Circuit Protection		Auto Recovery. No damage will occur when any output is short circuited. The output shall return to normal when the fault condition is removed.			
Over Voltage Protection		Limits output voltage at no load and in case the normal voltage limit fails.			

## Dimming

### ● DALI Dimming

The recommended implementation of the dimming control is provided below.

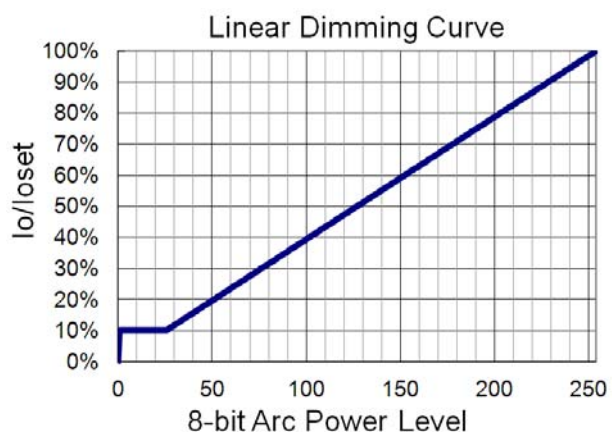
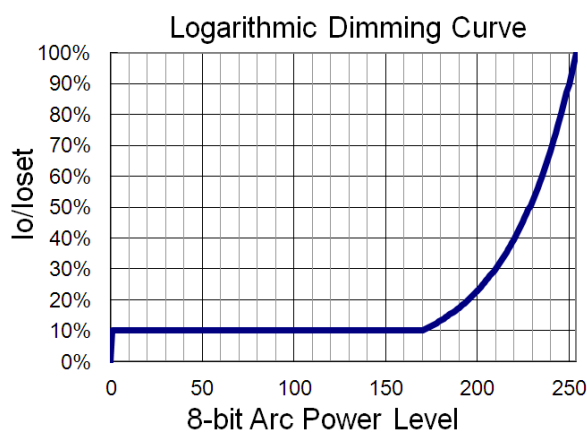
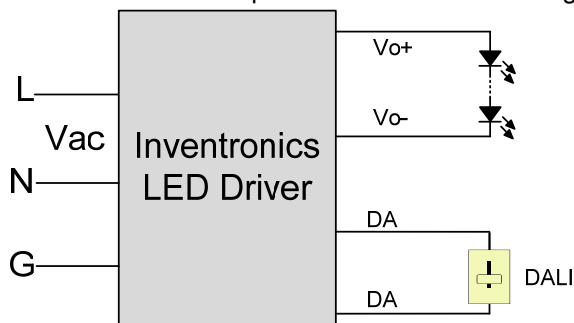

Implementation: DALI Dimming

## ● Time Dimming

Time dimming control includes 3 kinds of modes, they are Self Adapting-Midnight, Self Adapting-Percentage and Traditional Timer.

- **Self Adapting-Midnight:** Automatically adjusts the dimming curve based on the on-time of past two days (if difference <15 minutes), assuming that the center point of the dimming curve is midnight local time.
- **Self Adapting-Percentage:** Automatically adjusts the on-time of each step by a constant percentage = (actual on-time for the past 2 days if difference <15 min) / (programmed on-time from the dimming curve).
- **Traditional Timer:** Follows the programmed timing curve after power on with no changes.

## ● Output Lumen Compensation

Output Lumen Compensation (OLC) may be used to maintain constant light output over the life of the LEDs by driving them at a reduced current when new, then gradually increasing the drive current over time to counteract LED lumen degradation.

## Programming Connection Diagram

EUD-200SxxxBVA

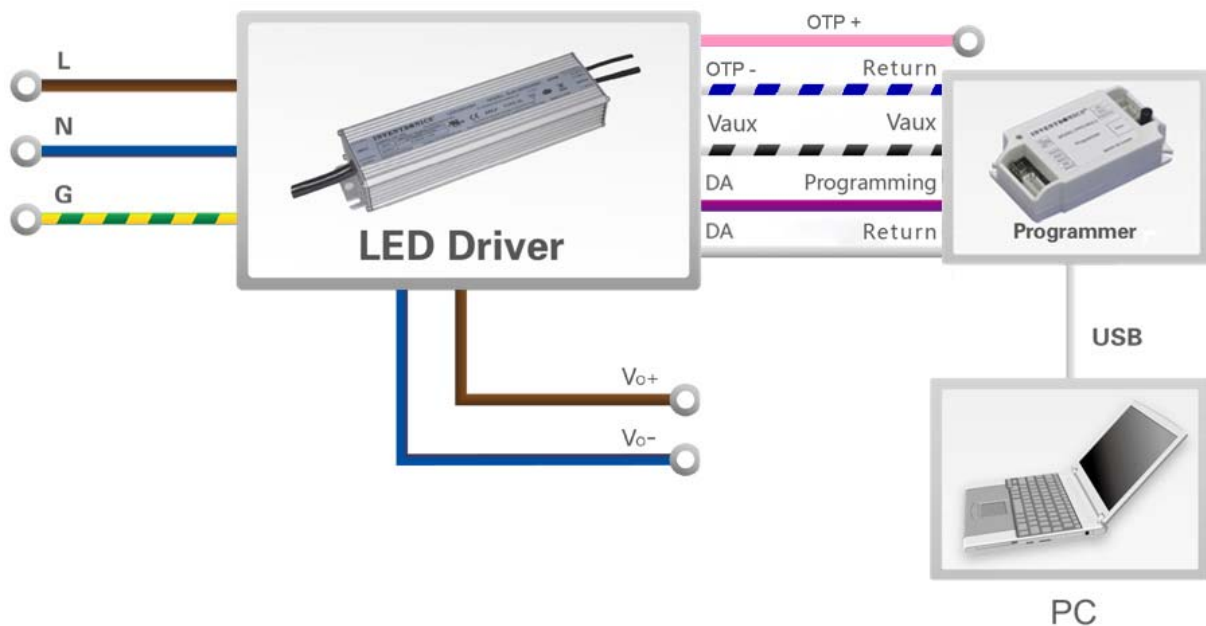





## Revision History

Change Date	Rev.	Description of Change		
		Item	From	To
2017-03-02	A	Datasheets Release	/	/
2017-10-26	B	Features	7 Years Warranty	Added
		Input Specifications	PF/THD	Updated
		Output Specifications	Temperature Coefficient of loset	Updated
		General Specifications	Operating Case Temperature for Warranty Tc_w	Updated
2019-10-28	C	CCC Logo	/	Updated
		Independent Logo	/	Added
		Features	Timer Dimmable (3 Timer Modes)	3-Timer-Modes Dimmable
		Features	6kV line-line, 10kV line-earth	DM 6kV, CM 10kV
		Features	Waterproof (IP67)	IP67
		Features	Suitable for Independent Use	Deleted
		Description	Application Environment	Updated
		Models- Input –Voltage Range(2)	127~250 Vdc	100~250 Vdc
		Models- Notes(2)	/	Updated
		Input Specifications- Input Voltage	127~250 Vdc	100~250 Vdc
		Safety &EMC Compliance	ENEC	Added
		Safety &EMC Compliance	TUV	Added
		Safety &EMC Compliance	CB	Added
		Safety &EMC Compliance	CCC	Added
		Safety &EMC Compliance	PSE	Added
		Safety &EMC Compliance	Global Mark	Added
		Safety &EMC Compliance	EN 55015	EN 55015/GB 17743 <sup>(1)</sup>
		Safety &EMC Compliance	EN 61000-3-2	EN 61000-3-2/GB 17625.1
		Safety &EMC Compliance	EN 61000-4-5	Updated
RoHS Compliance	/	Updated		
2020-04-15	D	BIS Logo	/	Added
		Models	Notes(7)	Added
		Safety &EMC Compliance	BIS	Added

## Revision History (Continued)

Change Date	Rev.	Description of Change		
		Item	From	To
2020-04-15	D	Programming Connection Diagram	EUD-200SxxxBVA-3000	Added
		Mechanical Outline	EUD-200SxxxBVA-3000	Added
		Format	Page footer	Updated