

## Features

- Ultra High Efficiency (Up to 93%)
- Full Power at Wide Output Current Range (Constant Power)
- 0-10V/PWM/3-Timer-Modes Dimmable
- Dim-to-Off with Standby Power  $\leq$  1W
- Output Lumen Compensation
- Input Surge Protection: DM 6kV
- All-Around Protection: OVP, SCP, OTP
- IP67
- Class II
- Suitable for Built-in Use
- 5 Years Warranty



## Description

The EUD-200SxxxDD series is a 200W, constant-current, programmable LED driver that operates from 90-305 Vac input with excellent power factor. Created for many lighting applications including high bay, high mast and roadway, etc, it provides a dim-to-off mode with low standby power. The high efficiency of these drivers and compact metal case enables them to run cooler, significantly improving reliability and extending product life. To ensure trouble-free operation, protection is provided against input surge, output over voltage, short circuit, and over temperature.

## Models

Adjustable Output Current Range	Full-Power Current Range (1)	Default Output Current	Input Voltage Range(2)	Output Voltage Range	Max. Output Power	Typical Efficiency (3)	Typical Power Factor		Model Number (4)
							120Vac	220Vac	
70-1050mA	700-1050mA	700 mA	90~305 Vac 127~250 Vdc	120~285Vdc	200 W	93.0%	0.99	0.96	EUD-200S105DD
105-1500mA	1050-1500mA	1400 mA	90~305 Vac 127~250 Vdc	80~190Vdc	200 W	93.0%	0.99	0.96	EUD-200S150DD

- Notes:** (1) Output current range with constant power at 200W  
 (2) Certified input voltage range: 100-240Vac or 127-250Vdc (except KS)  
 (3) Measured at 100% load and 220Vac input (see below "General Specifications" for details).  
 (4) All the models are certificated to KS, except EUD-200S105DD

## I-V Operating Area

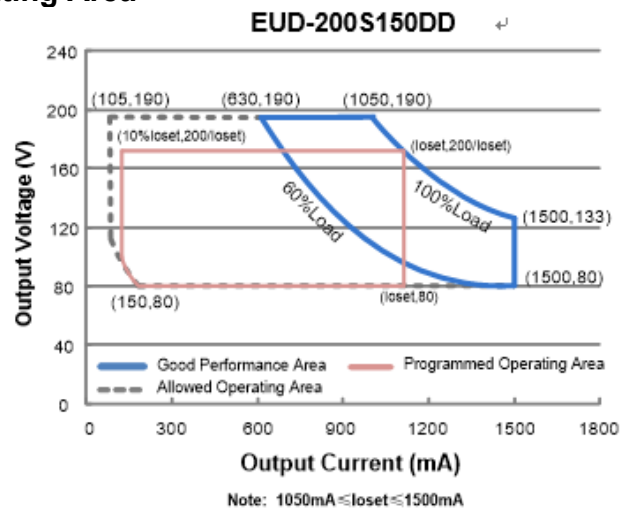
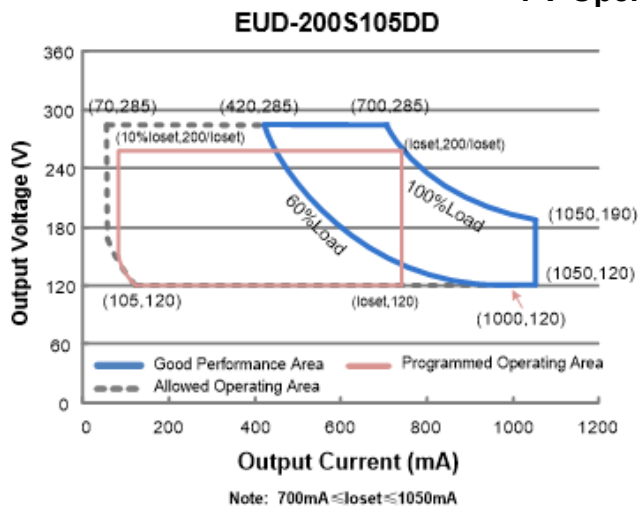

## Input Specifications

Parameter	Min.	Typ.	Max.	Notes
Input AC Voltage	90 Vac	-	305 Vac	
Input DC Voltage	127 Vdc	-	250 Vdc	
Input Frequency	47 Hz	-	63 Hz	
Leakage Current	-	-	0.70 mA	IEC 60598-1; 240Vac/ 60Hz
Input AC Current	-	-	2.0A	Measured at 100% load and 120 Vac input.
	-	-	1.0 A	Measured at 100% load and 220 Vac input.
Inrush Current(I <sup>2</sup> t)	-	-	5.97 A <sup>2</sup> s	At 220Vac input, 25°C cold start, duration=1.36 ms, 10% pk-10% pk. See Inrush Current Waveform for the details.
PF	0.90	-	-	At 100-240Vac, 50-60Hz, 60%-100% Load (120-200W)
THD	-	-	20%	

## Output Specifications

Parameter	Min.	Typ.	Max.	Notes
Output Current Tolerance	-5%Ioset	-	5%Ioset	100% load
Output Current Setting(Ioset) Range				
EUD-200S105DD	70 mA	-	1050 mA	
EUD-200S150DD	105 mA	-	1500 mA	
Output Current Setting Range with Constant Power				
EUD-200S105DD	700 mA	-	1050 mA	
EUD-200S150DD	1050 mA	-	1500 mA	
Total Output Current Ripple (pk-pk)	-	5%Iomax	10%Iomax	100% load, 20 MHz BW

## Output Specifications (Continued)

Parameter	Min.	Typ.	Max.	Notes
Output Current Ripple at < 200 Hz (pk-pk)	-	2%I <sub>o</sub> max	-	100% load
Startup Overshoot Current	-	-	10%I <sub>o</sub> max	100% load
No Load Output Voltage				
EUD-200S105DD	-	-	330 V	
EUD-200S150DD	-	-	220 V	
Line Regulation	-	-	±0.5%	100% load
Load Regulation	-	-	±1.5%	
Turn-on Delay Time	-	1.0 s	2.0 s	Measured at 120Vac and 220Vac input, 60%-100% Load
Temperature Coefficient of I <sub>o</sub> set	-	0.03%/°C	-	Case temperature = 0°C ~T <sub>c</sub> max
12V Auxiliary Output Voltage	10.8 V	12 V	13.2 V	
12V Auxiliary Output Source Current	0 mA	-	200 mA	Return terminal is "Dim-"

## General Specifications

Parameter	Min.	Typ.	Max.	Notes
Efficiency at 120 Vac input:				
EUD-200S105DD				Measured at 100% load and steady-state temperature in 25°C ambient; (Efficiency will be about 2.0% lower if measured immediately after startup.)
I <sub>o</sub> =700 mA	88.0%	90.0%	-	
I <sub>o</sub> =1050 mA	88.0%	90.0%	-	
EUD-200S150DD				
I <sub>o</sub> =1050 mA	89.0%	91.0%	-	
I <sub>o</sub> =1500 mA	88.0%	90.0%	-	
Efficiency at 220 Vac input:				
EUD-200S105DD				Measured at 100% load and steady-state temperature in 25°C ambient; (Efficiency will be about 2.0% lower if measured immediately after startup.)
I <sub>o</sub> =700 mA	91.0%	93.0%	-	
I <sub>o</sub> =1050 mA	91.0%	93.0%	-	
EUD-200S150DD				
I <sub>o</sub> =1050 mA	91.0%	93.0%	-	
I <sub>o</sub> =1500 mA	90.5%	92.5%	-	
Efficiency at 277 Vac input:				
EUD-200S105DD				Measured at 100% load and steady-state temperature in 25°C ambient; (Efficiency will be about 2.0% lower if measured immediately after startup.)
I <sub>o</sub> =700 mA	91.5%	93.5%	-	
I <sub>o</sub> =1050 mA	91.0%	93.0%	-	
EUD-200S150DD				
I <sub>o</sub> =1050 mA	91.5%	93.5%	-	
I <sub>o</sub> =1500 mA	91.0%	93.0%	-	
Standby power	-	1 W	-	Measured at 230Vac/50Hz; Dimming off
MTBF	-	288,000 Hours	-	Measured at 220Vac input, 80%Load and 25°C ambient temperature (MIL-HDBK-217F)
Lifetime	-	100,000 Hours	-	Measured at 220Vac input, 80%Load and 60°C case temperature; See lifetime vs. T <sub>c</sub> curve for the details
Operating Case Temperature for Safety T <sub>c_s</sub>	-40°C	-	+90°C	
Operating Case Temperature for Warranty T <sub>c_w</sub>	-40°C	-	+70°C	Case temperature for 5 years warranty Humidity: 5%RH to 95%RH

## General Specifications (Continued)

Parameter	Min.	Typ.	Max.	Notes
Storage Temperature	-40°C	-	+85°C	Humidity: 5%RH to 95%RH
Dimensions Inches (L × W × H) Millimeters (L × W × H)	8.82 × 2.66 × 1.56 224 × 67.5 × 39.5			With mounting ear 9.88 × 2.66 × 1.56 251 × 67.5 × 39.5
Net Weight	-	1200 g	-	

## Dimming Specifications

Parameter	Min.	Typ.	Max.	Notes
Absolute Maximum Voltage on the Vdim (+) Pin	-20 V	-	20 V	
Source Current on Vdim (+)Pin	200 µA	300 µA	450 µA	Vdim(+) = 0 V
Dimming Output Range	EUD-200S105DD	10%loset	-	700mA ≤ loiset ≤ 1050mA
	EUD-200S150DD			1050mA ≤ loiset ≤ 1500mA
Dimming Output Range	EUD-200S105DD	70mA	-	70mA ≤ loiset < 700mA
	EUD-200S150DD	105mA		105mA ≤ loiset < 1050mA
Recommended Dimming Input Range	0 V	-	10 V	Default 0-10V dimming mode.
Dim off Voltage	0.4 V	0.55V	0.7 V	
Dim on Voltage	0.6 V	0.75 V	0.9 V	
Hysteresis	-	0.2 V	-	
PWM_in High Level	3 V	-	10 V	Dimming mode set to PWM in Inventronics programming software.
PWM_in Low Level	-0.3 V	-	0.6 V	
PWM_in Frequency Range	200 Hz	-	3 KHz	
PWM_in Duty Cycle	1%	-	99%	
PWM Dimming off (Positive Logic)	3%	5%	8%	
PWM Dimming on (Positive Logic)	5%	7%	10%	
PWM Dimming off ( Negative Logic)	92%	95%	97%	
PWM Dimming on ( Negative Logic)	90%	93%	95%	
Hysteresis	-	2%	-	

## Safety & EMC Compliance

Safety Category	Standard
ENEC & CE <sup>(1)</sup>	EN 61347-1 <sup>(2)</sup> , EN61347-2-13
CB	IEC 61347-1, IEC 61347-2-13
KS	KS C 7655

## Safety & EMC Compliance (Continued)

EMI Standards	Notes
EN IEC 55015 <sup>(3)</sup>	Conducted emission Test & Radiated emission Test
EN IEC 61000-3-2	Harmonic current emissions
EN 61000-3-3	Voltage fluctuations & flicker
EMS Standards	Notes
EN 61000-4-2	Electrostatic Discharge (ESD): 8 kV air discharge, 4 kV contact discharge
EN 61000-4-3	Radio-Frequency Electromagnetic Field Susceptibility Test-RS
EN 61000-4-4	Electrical Fast Transient / Burst-EFT
EN 61000-4-5	Surge Immunity Test: AC Power Line: Differential Mode 6 kV
EN 61000-4-6	Conducted Radio Frequency Disturbances Test-CS
EN 61000-4-8	Power Frequency Magnetic Field Test
EN 61000-4-11	Voltage Dips
EN 61547	Electromagnetic Immunity Requirements Applies To Lighting Equipment

- Note:** (1) For compliance with EU Directive 2009/125/EC (ecodesign requirements for energy-related products) the Dim-to-Off function shall not be used or alternatively be interrupted through use of a relay or similar device to prevent excessive standby power consumption (as illustrated in Implementation 4).  
 (2) This product meets all requirements for EN 61347-1, Annex O (Double insulation). However, the allowed leakage current could cause a mild shock if the case is touched while energized.  
 (3) This LED driver meets the EMI specifications above, but EMI performance of a luminaire that contains it depends also on the other devices connected to the driver and on the fixture itself.

## Lifetime vs. Case Temperature

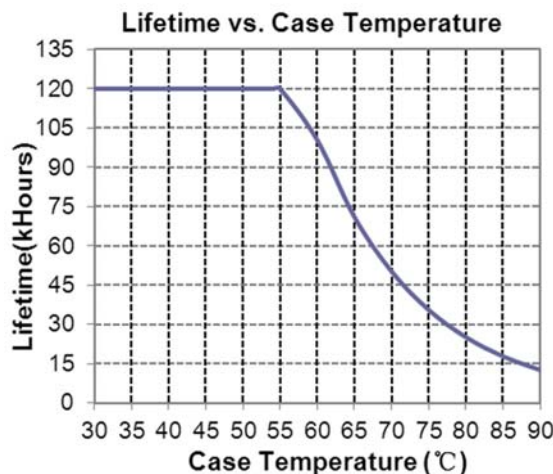

## Inrush Current Waveform

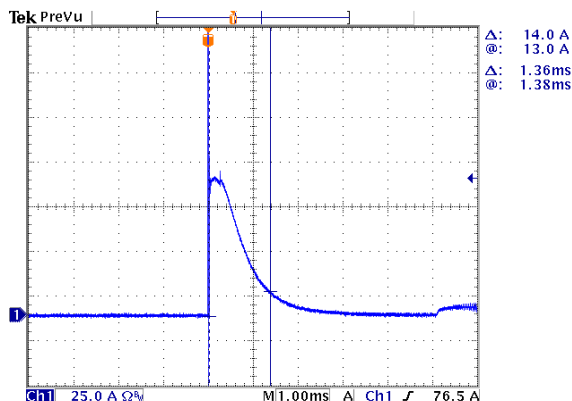

## Efficiency vs. Load

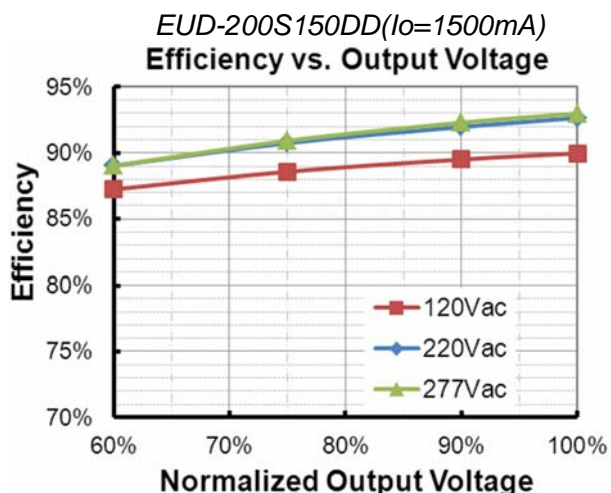
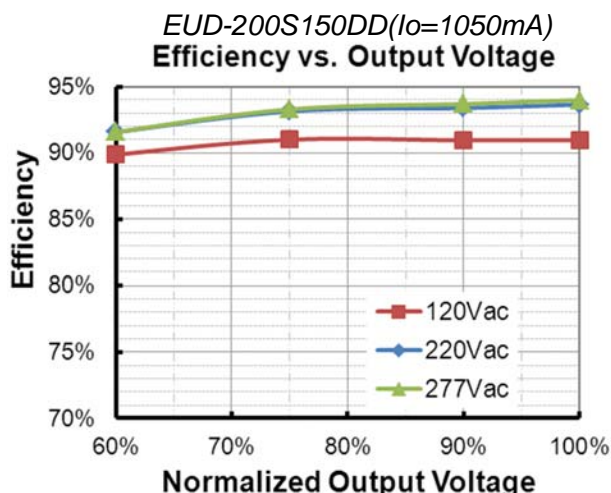
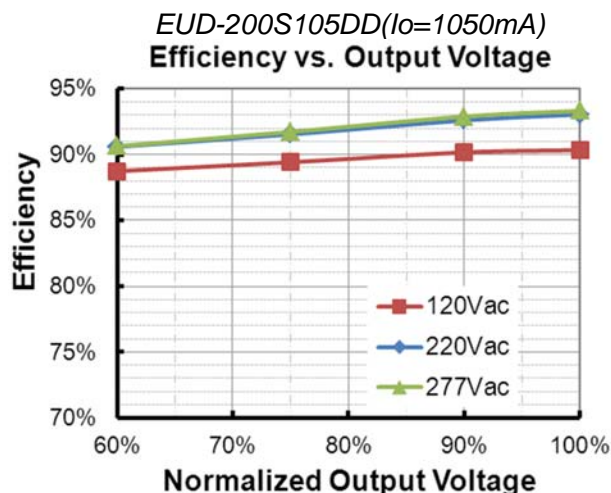
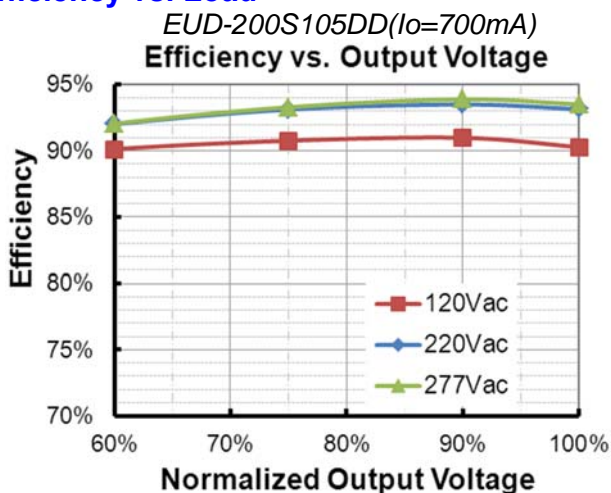



## Power Factor

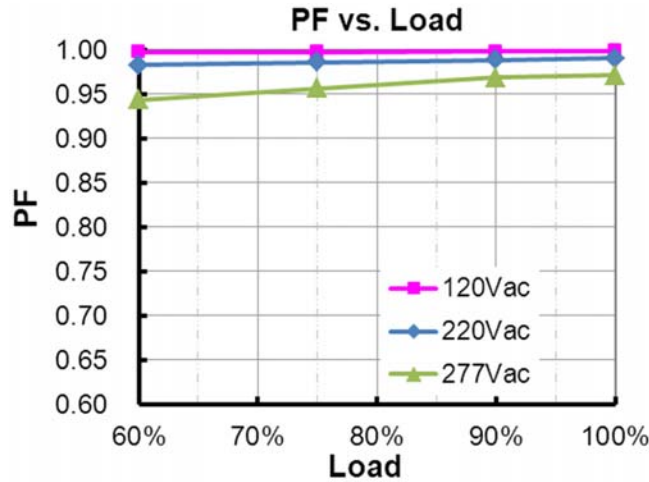

## Total Harmonic Distortion

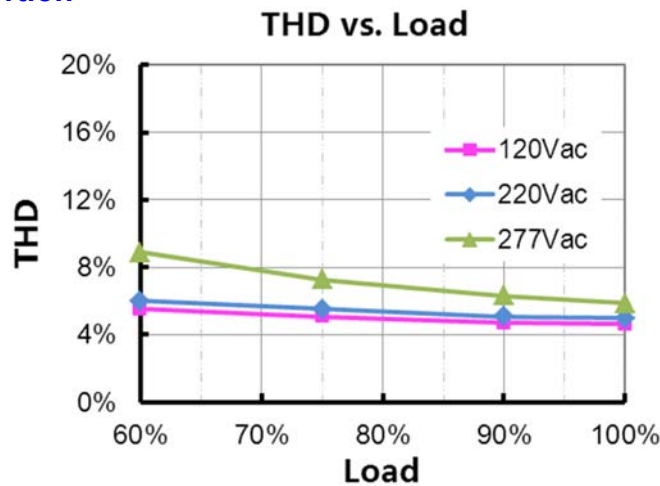

## Protection Functions

Parameter	Notes
Over Temperature Protection	Decreases output current, returning to normal after over temperature is removed.
Short Circuit Protection	Auto Recovery. No damage will occur when any output is short circuited. The output shall return to normal when the fault condition is removed.
Over Voltage Protection	Limits output voltage at no load and in case the normal voltage limit fails.

## Dimming

### ● 0-10V Dimming

The recommended implementation of the dimming control is provided below.

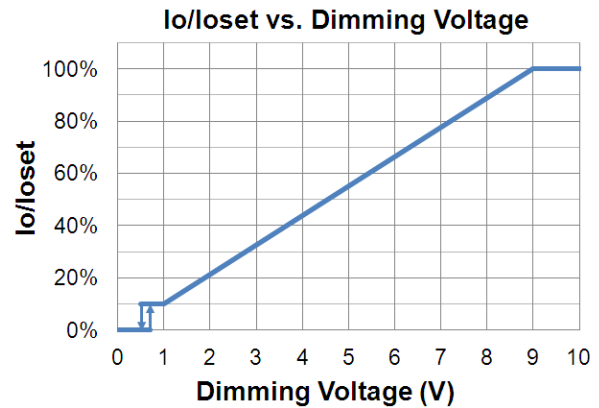
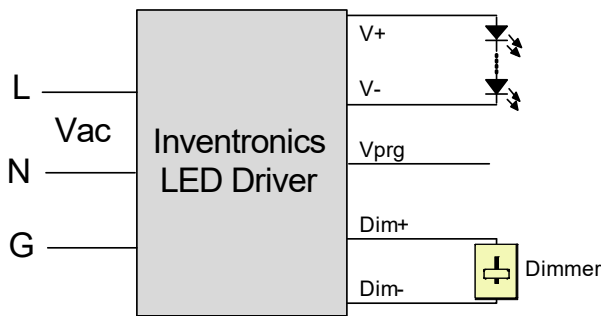

**Implementation 1: DC Input**

**Notes:**

1. Do NOT connect Dim- to the output V- or V+, otherwise the driver will not work properly.
2. The dimmer can also be replaced by an active 0-10V voltage source signal or passive components like zener.

**● PWM Dimming**

The recommended implementation of the dimming control is provided below.

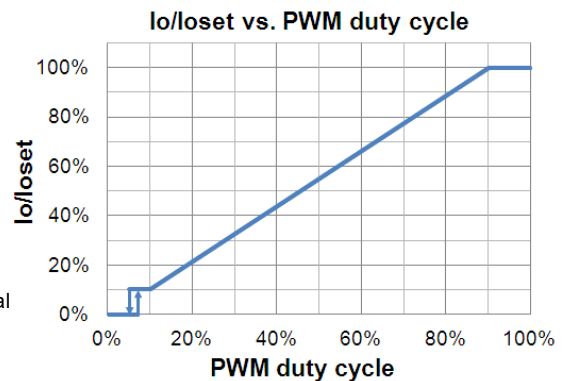
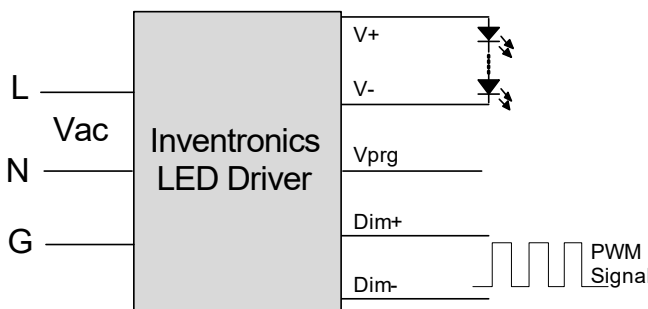

**Implementation 2: Positive logic**

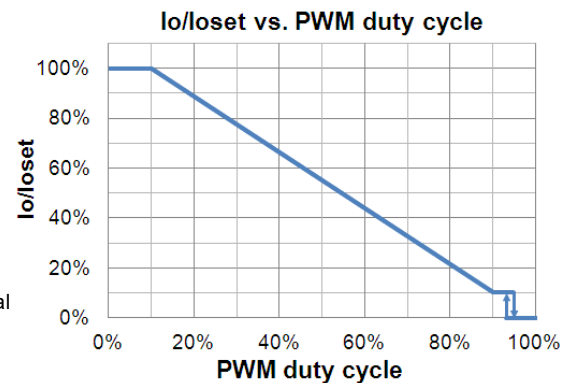
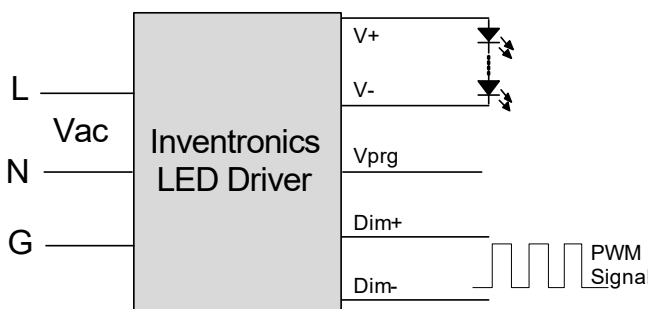

**Implementation 3: Negative logic**



● **Time Dimming**

Time dimming control includes 3 kinds of modes, they are Self Adapting-Midnight, Self Adapting-Percentage and Traditional Timer.

- **Self Adapting-Midnight:** Automatically adjusts the dimming curve based on the on-time of past two days (if difference <15 minutes), assuming that the center point of the dimming curve is midnight local time.
- **Self Adapting-Percentage:** Automatically adjusts the on-time of each step by a constant percentage = (actual on-time for the past 2 days if difference <15 min) / (programmed on-time from the dimming curve).
- **Traditional Timer:** Follows the programmed timing curve after power on with no changes.

● **0% Light Brightness**

If the brightness of the LED lighting fixture down to 0%, please refer to the following wiring method. The lamp can be turned on/off using a switch and relay.

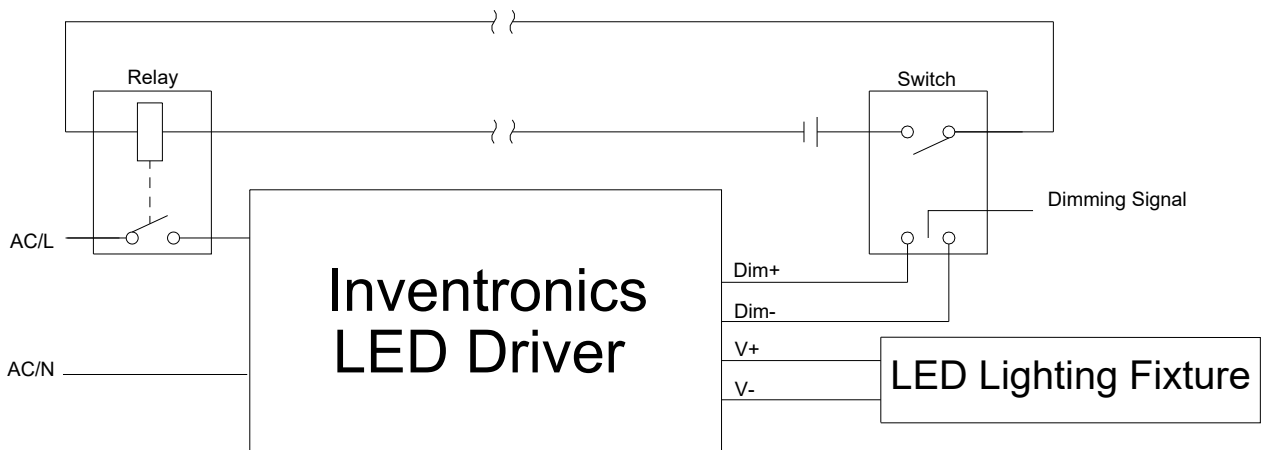

**Implementation 4: 0% Light Brightness Wiring Method**

● **Output Lumen Compensation**

Output Lumen Compensation (OLC) may be used to maintain constant light output over the life of the LEDs by driving them at a reduced current when new, then gradually increasing the drive current over time to counteract LED lumen degradation.

**Programming Connection Diagram**

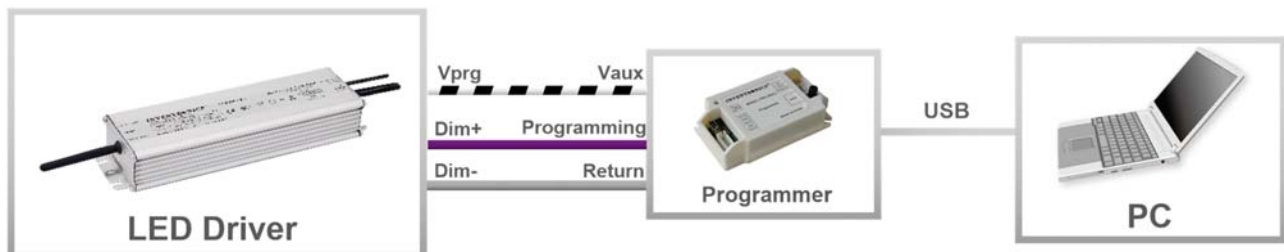

**Note:** The driver does not need to be powered on during the programming process.

- Please refer to [PRG-MUL2](#) Multi-Programmer datasheet for details.

## Mechanical Outline

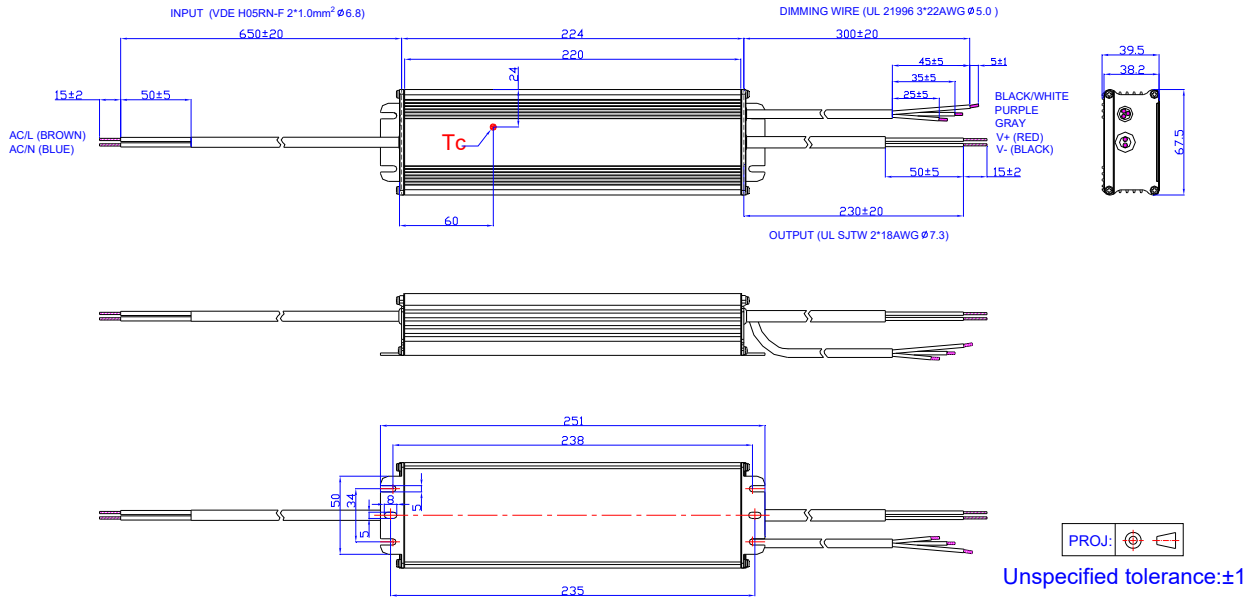

## RoHS Compliance

Our products comply with reference to RoHS Directive (EU) 2015/863 amending 2011/65/EU, calling for the elimination of lead and other hazardous substances from electronic products.

## Revision History

Change Date	Rev.	Description of Change		
		Item	From	To
2015-03-10	A	Datasheets Release	/	/
2018-04-03	B	Description	/	Updated
		Models	Output Current Range	Adjustable Output Current Range
		Input Specifications	PF/THD	Updated
		Output Specifications	Temperature Coefficient of Isoet	Updated
		General Specifications	Dimensions	Updated
		Safety &EMC Compliance	/	Updated
		Programming Connection Diagram	/	Updated
		Mechanical Outline	/	Updated
2018-06-14	C	Features	5 Years Warranty	Updated
		Output Specifications	No Load Output Voltage	Updated
		Input Specifications	Turn-on Delay Time	Updated
		Standby power	Max 1W	Typ 1W
		Operating Case Temperature for Warranty Tc_w	/	Updated
2019-09-20	D	KS Logo	/	Added
		Features	0-10V/PWM/Timer Dimmable (3 Timer Modes)	0-10V/PWM/3-Timer-Modes Dimmable
		Features	6kV line-line	DM 6kV
		Features	Waterproof (IP67)	IP67
		Models	Notes(4)	Added
		Safety &EMC Compliance	ENEC	Added
		Safety &EMC Compliance	TUV	Added
		Safety &EMC Compliance	CB	Added
		Safety &EMC Compliance	KS	Added
		Safety &EMC Compliance	EN 61000-4-5	Updated
		Mechanical Outline	/	Updated
		RoHS Compliance	/	Updated
2021-11-26	E	Safety &EMC Compliance	Note(1)	Updated
		0% Light Brightness	/	Updated

## Revision History (Continued)

Change Date	Rev.	Description of Change		
		Item	From	To
2023-08-24	F	TUV logo	/	Deleted
		Product Photograph	/	Updated
		Safety &EMC Compliance	/	Updated
		Programming Connection Diagram	/	Updated