

## Features

- Ultra High Efficiency (Up to 93.5%)
- Programmable Constant-Current Output
- DMX512 Dimmable
- Standby Power  $\leq 1$  W
- Input surge protection: 4kV line-line, 6kV line-earth
- All-Around Protection: OVP, SCP, OTP
- Waterproof (IP67)
- SELV Output
- Suitable for Independent Use



## Description

The EUD-200SxxxGV series is a 200W, constant-current, programmable LED driver that operates from 90-305 Vac input with excellent power factor. Created for arena, theatrical and architectural lights, it provides a dim-to-off mode with low standby power. The high efficiency of these drivers and compact metal case enables them to run cooler, significantly improving reliability and extending product life. To ensure trouble-free operation, protection is provided against over input surge, output voltage, short circuit, and over temperature.

## Models

Max. Output Current	Input Voltage Range(1)	Output Voltage Range	Max. Output Power	Typical Efficiency (2)	Power Factor		Model Number (3)
					120Vac	220Vac	
700 mA	90 ~ 305 Vac 127~250 Vdc	143~286Vdc	200 W	93.5%	0.99	0.96	EUD-200S070GV
1050 mA	90 ~ 305 Vac 127~250 Vdc	95~190Vdc	200 W	93.5%	0.99	0.96	EUD-200S105GV
1400 mA	90 ~ 305 Vac 127~250 Vdc	71~142Vdc	200 W	93.0%	0.99	0.96	EUD-200S140GV
2100 mA	90 ~ 305 Vac 127~250 Vdc	47~ 95 Vdc	200 W	93.0%	0.99	0.96	EUD-200S210GV <sup>(4)</sup>
2450 mA	90 ~ 305 Vac 127~250 Vdc	41~ 82 Vdc	200 W	93.5%	0.99	0.96	EUD-200S245GV <sup>(4)</sup>
2800 mA	90 ~ 305 Vac 127~250 Vdc	35~ 71 Vdc	200 W	92.5%	0.99	0.96	EUD-200S280GV <sup>(4)</sup>
4200 mA	90 ~ 305 Vac 127~250 Vdc	24~ 48 Vdc	200 W	93.0%	0.99	0.96	EUD-200S420GV <sup>(4)</sup>
4900 mA	90 ~ 305 Vac 127~250 Vdc	21~ 41 Vdc	200 W	92.0%	0.99	0.96	EUD-200S490GV <sup>(4)</sup>

- Notes:** (1) Certified input voltage range: 100-240Vac or 127-250Vdc (except KS)  
 (2) Measured at full load and 220 Vac input.  
 (3) All the models are certificated to KS, except EUD-200S070GV  
 (4) SELV Output

## Input Specifications

Parameter	Min.	Typ.	Max.	Notes
Input Voltage	90 Vac	-	305 Vac	127~250 Vdc
Input Frequency	47 Hz	-	63 Hz	
Leakage Current	-	-	0.70 mA	IEC60598-1; 240Vac/ 60Hz, grounding effectively
Input AC Current	-	-	2.4 A	Measured at full load and 100 Vac input.
	-	-	1.2 A	Measured at full load and 220 Vac input.
Inrush Current(I <sup>2</sup> t)	-	-	3.2 A <sup>2</sup> s	At 220Vac input, 25°C cold start, duration=1.7 ms, 10%Ipk-10%Ipk. See Inrush Current Waveform for the details.
PF	0.90	-	-	At 100-277Vac, 75%-100% Load (150-200W)
THD	-	-	20%	

## Output Specifications

Parameter	Min.	Typ.	Max.	Notes
Output Current Tolerance	-5%Iomax	-	5%Iomax	At full load condition
Output Current Setting(losset) Range	10%Iomax	-	100%Iomax	
Total Output Current Ripple (pk-pk)	-	5%Iomax	10%Iomax	At full load condition, 20 MHz BW
Output Current Ripple at < 200 Hz (pk-pk)	-	2%Iomax	-	At full load condition. Only this component of ripple is associated with visible flicker.
Startup Overshoot Current	-	-	10%Iomax	At full load condition
No Load Output Voltage				
EUD-200S070GV	-	-	305V	
EUD-200S105GV	-	-	205V	
EUD-200S140GV	-	-	155V	
EUD-200S210GV	-	-	110V	
EUD-200S245GV	-	-	95V	
EUD-200S280GV	-	-	80V	
EUD-200S420GV	-	-	55V	
EUD-200S490GV	-	-	48V	
Line Regulation	-	-	±0.5%	Measured at full load
Load Regulation	-	-	±1.5%	
Turn-on Delay Time	-	0.8 s	1.5 s	Measured at 120Vac and 220Vac input.
Temperature Coefficient of Iomax	-	-	0.03%/°C	Case temperature = 0°C ~Tc max

**Note:** All specifications are typical at 25 °C unless otherwise stated.

## General Specifications

Parameter	Min.	Typ.	Max.	Notes
Efficiency at 120 Vac input: EUD-200S070GV EUD-200S105GV EUD-200S140GV EUD-200S210GV EUD-200S245GV EUD-200S280GV EUD-200S420GV EUD-200S490GV	88.0% 88.0% 87.0% 87.0% 88.0% 86.0% 87.5% 87.0%	91.0% 91.0% 90.0% 90.0% 91.0% 89.0% 90.5% 90.0%	- - - - - - - -	Measured at full load and steady-state temperature in 25°C ambient; (Efficiency will be about 2.0% lower if measured immediately after startup.)
Efficiency at 220 Vac input: EUD-200S070GV EUD-200S105GV EUD-200S140GV EUD-200S210GV EUD-200S245GV EUD-200S280GV EUD-200S420GV EUD-200S490GV	91.5% 91.5% 91.0% 91.0% 91.5% 90.5% 91.0% 90.0%	93.5% 93.5% 93.0% 93.0% 93.5% 92.5% 93.0% 92.0%	- - - - - - - -	Measured at full load and steady-state temperature in 25°C ambient; (Efficiency will be about 2.0% lower if measured immediately after startup.)
Efficiency at 277 Vac input: EUD-200S070GV EUD-200S105GV EUD-200S140GV EUD-200S210GV EUD-200S245GV EUD-200S280GV EUD-200S420GV EUD-200S490GV	92.0% 91.5% 91.0% 91.0% 91.5% 91.0% 91.5% 90.5%	94.0% 93.5% 93.0% 93.0% 93.5% 93.0% 93.5% 92.5%	- - - - - - - -	Measured at full load and steady-state temperature in 25°C ambient; (Efficiency will be about 2.0% lower if measured immediately after startup.)
Standby power	-	-	1 W	Measured at 230Vac/50Hz; Dimming off
MTBF	-	341,000 Hours	-	Measured at 220Vac input, 80%Load and 25°C ambient temperature (MIL-HDBK-217F)
Lifetime	-	120,000 Hours	-	Measured at 220Vac input, 80%Load and 60°C case temperature; See lifetime vs. Tc curve for the details
Operating Case Temperature for Safety Tc_s	-40°C	-	+90°C	
Operating Case Temperature for Warranty Tc_w	-40°C	-	+70°C	
Storage Temperature	-40°C	-	+85°C	Humidity: 5%RH to 100%RH
Dimensions Inches (L × W × H) Millimeters (L × W × H)	8.82 × 2.66 × 1.56 224 × 67.5 × 39.5			With mounting ear 9.88 × 2.66 × 1.56 251 × 67.5 × 39.5
Net Weight	-	1200 g	-	

**Note:** All specifications are typical at 25 °C unless stated otherwise.

## Dimming Specifications

Parameter	Min.	Typ.	Max.	Notes
DMX+ to DMX-	-6 V	-	6 V	
DMX+ to Chassis	22M ohm	-	-	At 42Vdc
DMX- to Chassis	22M ohm	-	-	At 42Vdc
Logic 0 Input	-	-	-0.2 V	DMX+ to DMX-
Logic 1 Input	0.2 V	-	-	DMX+ to DMX-
Communication Baud Rate	-	250k bps	-	
Dimming Output Range	10%Iomax	-	100%Ioset	10%Iomax ≤ Ioset ≤ 100%Iomax

**Note:** All specifications are typical at 25 °C unless stated otherwise.

## Standards Compliance

Safety Category	Standard
CE	EN 61347-1, EN61347-2-13
KS	KS C 7655
EMI standards	Notes
EN 55015 <sup>(1)</sup>	Conducted emission Test & Radiated emission Test
EN 61000-3-2	Harmonic current emissions
EN 61000-3-3	Voltage fluctuations & flicker
EMS standards	Notes
EN 61000-4-2	Electrostatic Discharge (ESD): 8 kV air discharge, 4 kV contact discharge
EN 61000-4-3	Radio-Frequency Electromagnetic Field Susceptibility Test-RS
EN 61000-4-4	Electrical Fast Transient / Burst-EFT
EN 61000-4-5	Surge Immunity Test: AC Power Line: line to line 4 kV, line to earth 6 kV <sup>(2)</sup>
EN 61000-4-6	Conducted Radio Frequency Disturbances Test-CS
EN 61000-4-8	Power Frequency Magnetic Field Test
EN 61000-4-11	Voltage Dips
EN 61547	Electromagnetic Immunity Requirements Applies To Lighting Equipment
DMX512 Standards	Notes
DMX512	E.11-2008(R2013) USITT DMX512-A
RS-485	EIA/TIA-485

**Note:** (1) This LED driver meets the EMI specifications above, but EMI performance of a luminaire that contains it depends also on the other devices connected to the driver and on the fixture itself.

- (2) To perform electric strength (hi-pot) testing, the “GDT ground disconnect” (nut and metal lock sheet) on the driver end-cap should be removed temporarily to prevent the internal gas discharge tube from conducting (as allowed by IEC 60598-1 Clause 10.2). After testing is completed, these items must be reinstalled to restore line-to-earth surge protection and secure the end cap.

## Lifetime vs. Case Temperature

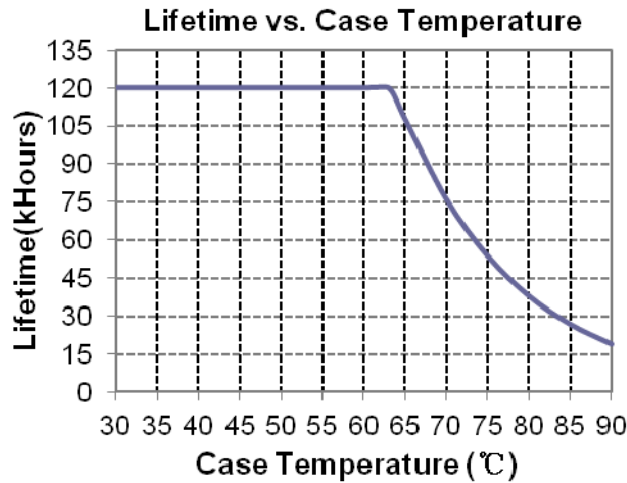

## Inrush Current Waveform

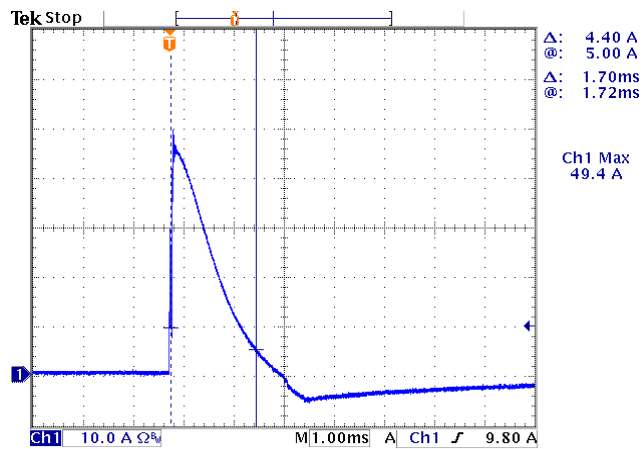

## Efficiency vs. Load

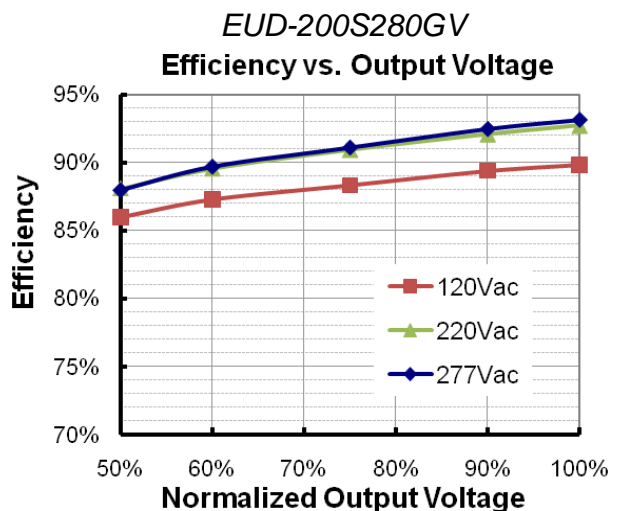
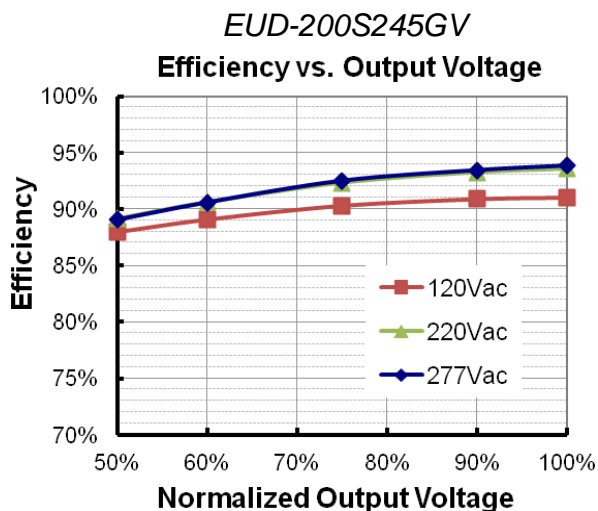
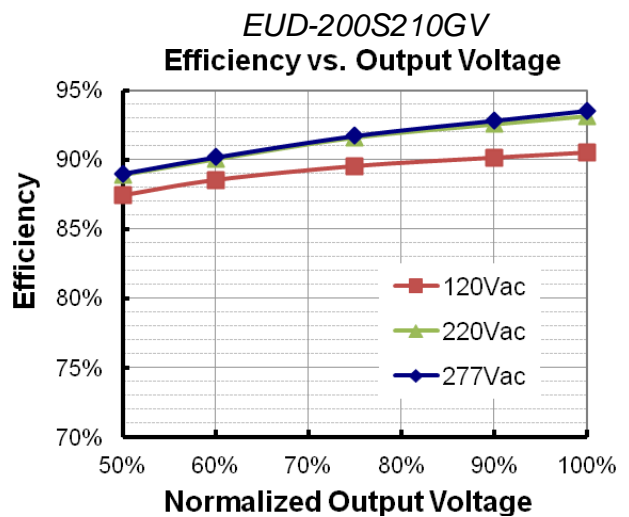
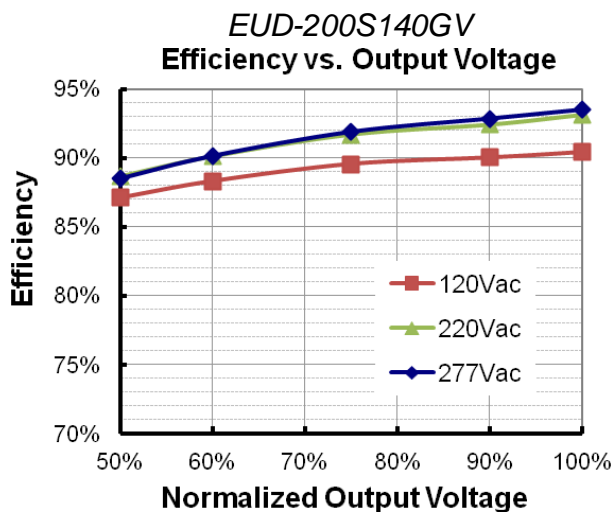
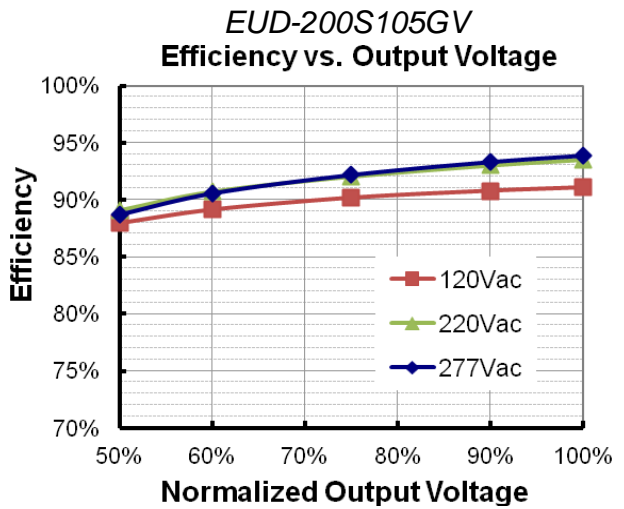
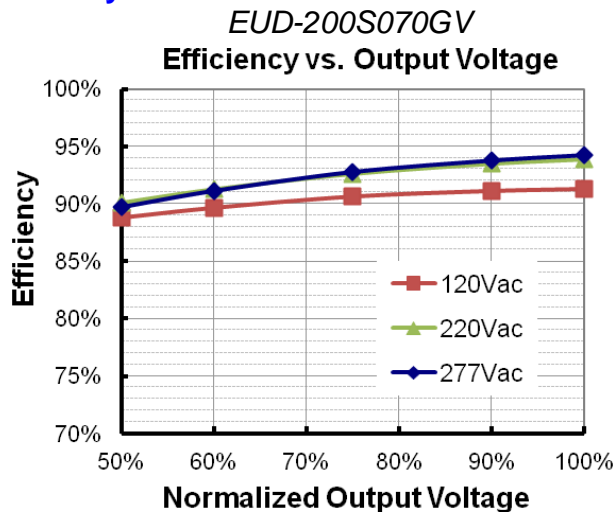

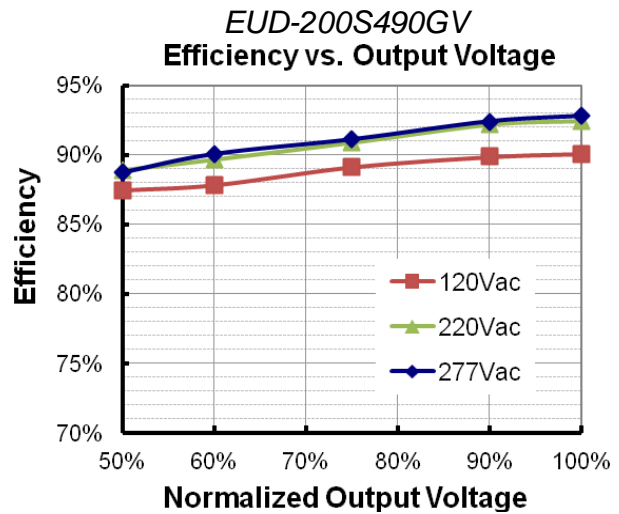
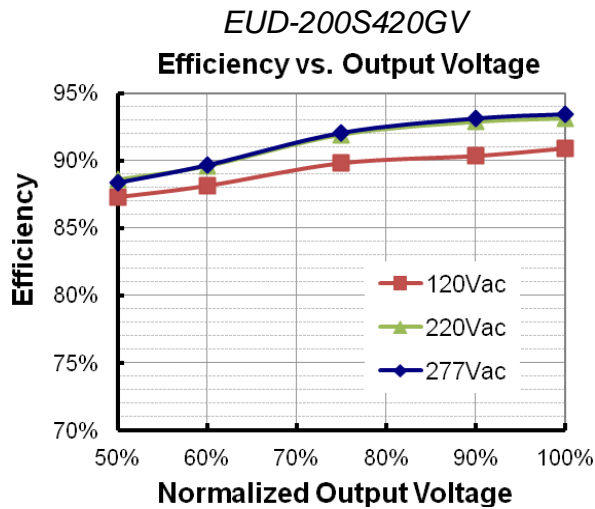

## Power Factor

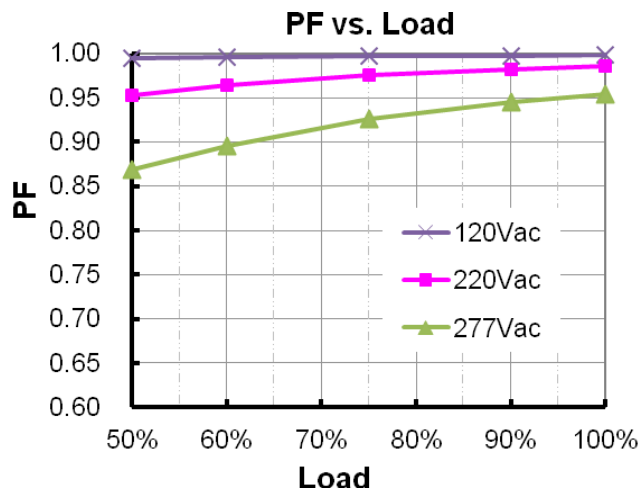

## Total Harmonic Distortion

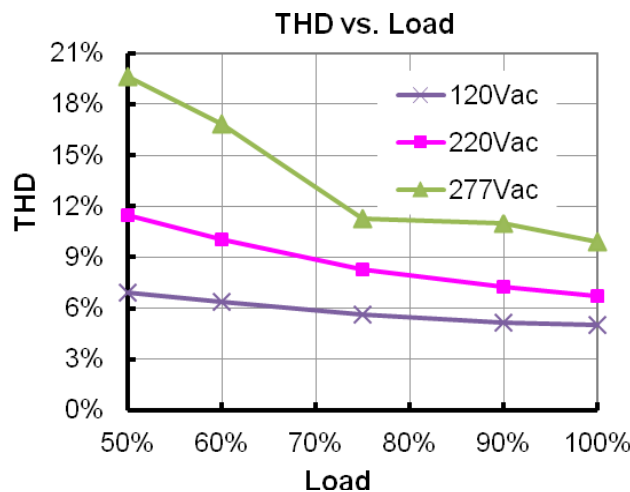

## Protection Functions

Parameter	Notes
Over Temperature Protection	Decreases output current, returning to normal after over temperature is removed.
Short Circuit Protection	Auto Recovery. No damage will occur when any output is short circuited. The output shall return to normal when the fault condition is removed.
Over Voltage Protection	Limits output voltage at no load and in case the normal voltage limit fails.

## Dimming

### ● DMX512 Dimming

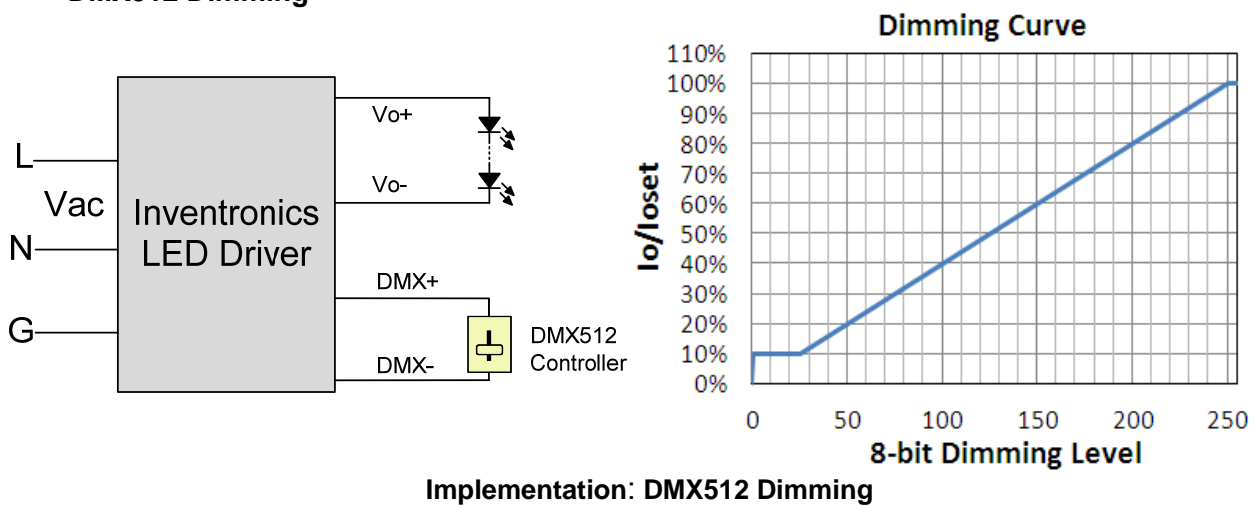



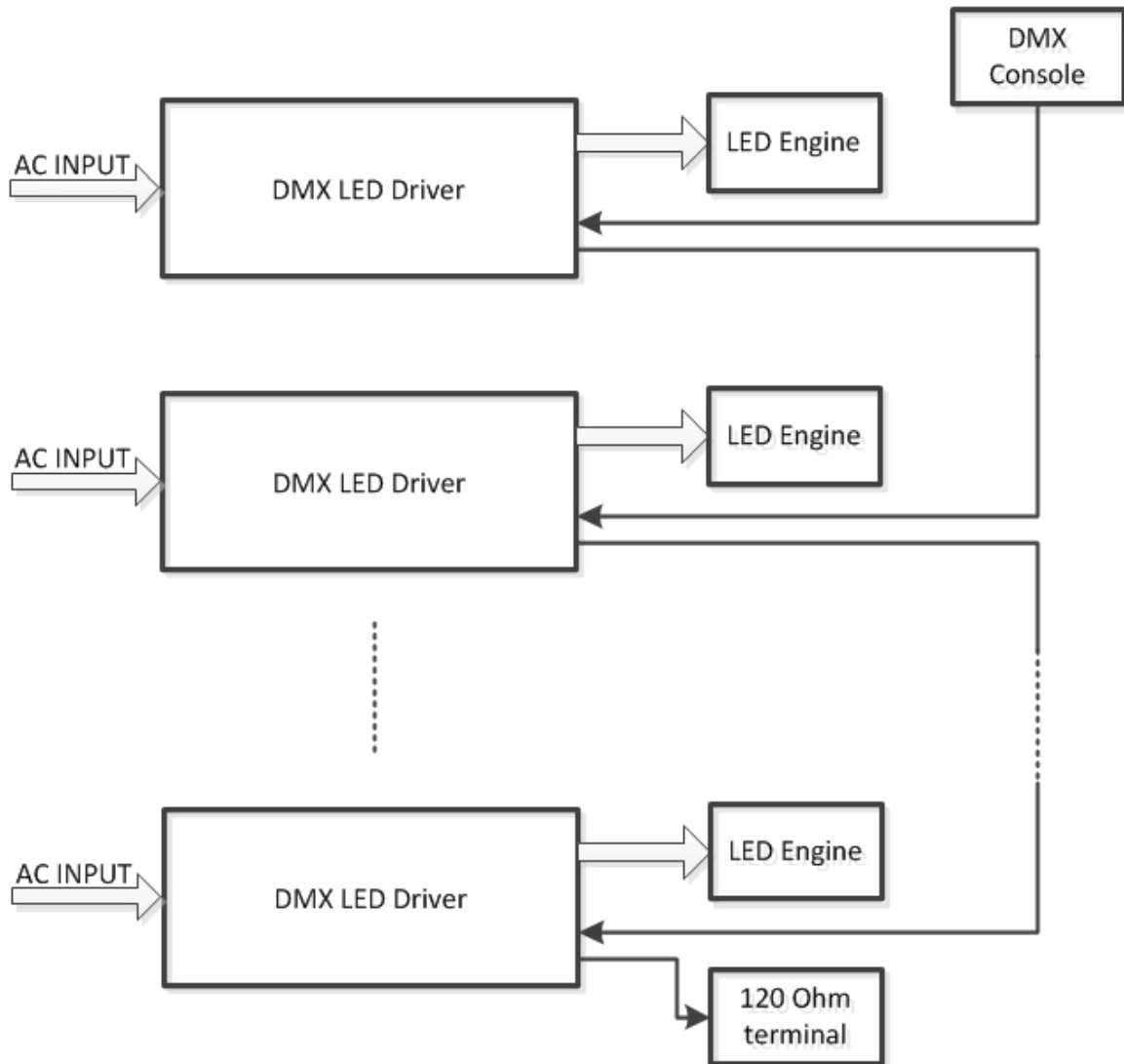

### Implementation: DMX512 Daisy chain

- Note:** (1) Up to 32 drivers may be daisy-chained, terminated by a 120 ohm resistor (connected between DMX+ & DMX- at the last driver)  
(2) 300m maximum length  
(3) 100m maximum between drivers  
(4) For best performance, a characteristic impedance of 120 ohms should be maintained for the entire length of the control line.

● Dimming Connection Diagram

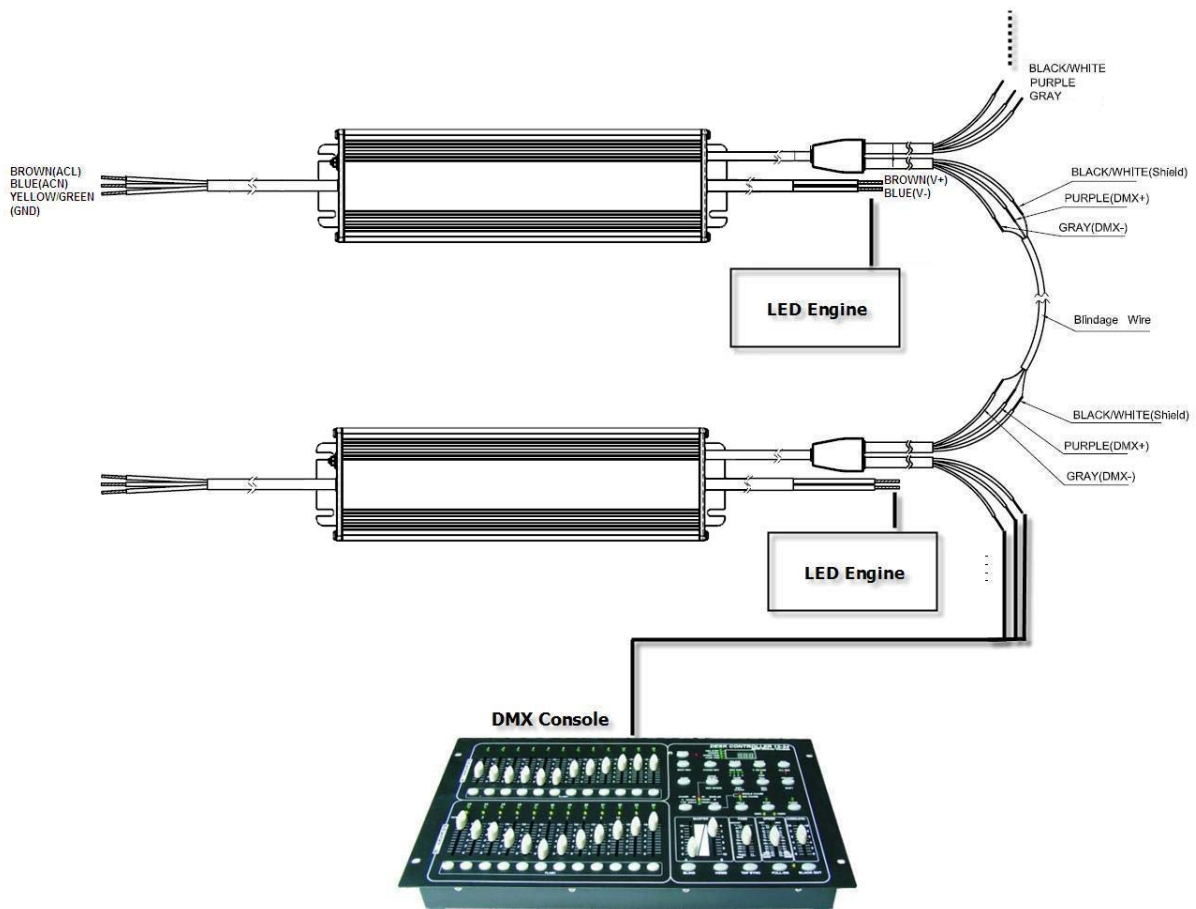

Programming Connection Diagram

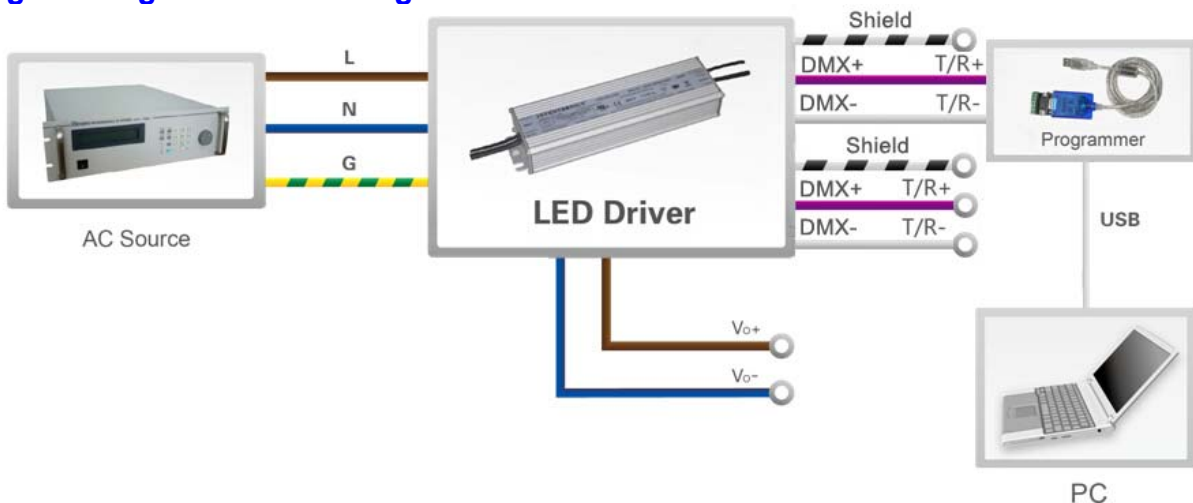

**Note:** The driver needs to be powered on during the programming process.

- Please refer to [UT-890](#) Programmer datasheet for details.



## Revision History

Change Date	Rev.	Description of Change		
		Item	From	To
2015-03-13	A	Datasheets Release	/	/
2016-01-25	B	KS	/	Added
		External Grounding Screw Solution	/	/
		Features	/	Updated
		Safety & EMC Compliance	Standards Compliance	Updated
		DMX512 Standards	/	Added
		Dimming	/	Updated
		Programming Connection Diagram	/	Updated
2016-03-31	C	General Specifications	With mounting ear	Updated
		Safety & EMC Compliance	/	Updated
2016-08-22	D	Global Mark	/	Added
		DMX512 Dimming	/	Updated
		Programming Connection Diagram	/	Updated
		Mechanical Outline	/	Updated
2017-03-07	E	Inrush Current(I <sup>2</sup> t)	/	Updated
2019-08-22	F	CCC Logo	/	Deleted
		PSE Logo	/	Deleted
		Global Mark Logo	/	Updated
		Models	Notes(1)	Updated
		Safety & EMC Compliance	KS	Updated