

Features

- Ultra High Efficiency (Up to 94%)
- Full Power at Wide Output Current Range (Constant Power)
- Thermal Sensing and Protection for LED Module
- DALI/Timer Dimmable (3 Timer Modes)
- Dim-to-Off with Standby Power ≤ 0.5 W
- Always-on Auxiliary Power: 12Vdc, 200mA (Transient Peak Current up to 400mA)
- Output Lumen Compensation
- Input Surge Protection: 6kV line-line, 10kV line-earth
- All-Around Protection: OVP, SCP, OTP
- Waterproof (IP67) and UL Dry / Damp / Wet Location
- SELV Output
- TYPE HL, for use in a Class I, Division 2 hazardous (Classified) location
- 7 Years Warranty

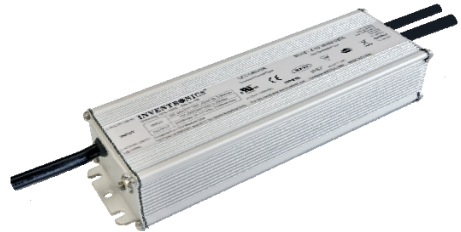

Description

The EUD-240SxxxBTA series is a 240W, constant-current, programmable LED driver that operates from 90-305 Vac input with excellent power factor. Created for many lighting applications including high bay, high mast, sports and roadway, it provides a dim-to-off mode with low standby power. The high efficiency of these drivers and compact metal case enables them to run cooler, significantly improving reliability and extending product life. To ensure trouble-free operation, protection is provided against input surge, output over voltage, short circuit, and over temperature.

Models

Adjustable Output Current Range	Full-Power Current Range (1)	Default Output Current	Input Voltage Range(2)	Output Voltage Range	Max. Output Power	Typical Efficiency (3)	Power Factor		Model Number (5)
							120Vac	220Vac	
70-1050mA	700-1050mA	1050 mA	90~305 Vac 127~300 Vdc	114~343Vdc	240W	94.0%	0.99	0.96	EUD-240S105BTA
105-1500mA	1050-1500mA	1050 mA	90~305 Vac 127~300 Vdc	80~229Vdc	240W	93.0%	0.99	0.96	EUD-240S150BTA
140-2100mA	1400-2100mA	1400 mA	90~305 Vac 127~300 Vdc	57~171Vdc	240W	93.5%	0.99	0.96	EUD-240S210BTA
280-4200mA	2800-4200mA	4200 mA	90~305 Vac 127~300 Vdc	29 ~ 86Vdc	240W	93.0%	0.99	0.96	EUD-240S420BTA ⁽⁴⁾
445-6700mA	4450-6700mA	6700 mA	90~305 Vac 127~300 Vdc	18 ~ 54Vdc	240W	93.0%	0.99	0.96	EUD-240S670BTA ⁽⁴⁾

Notes: (1) Output current range with constant power at 240W

(2) Certified voltage range: UL, FCC 100-277Vac or 127-300Vdc; otherwise 100-240Vac or 127-250Vdc (except KS)

(3) Measured at full load and 220Vac input (see below "General Specifications" for details).

(4) SELV Output

(5) All the models are certificated to KS, except EUD-240S105BTA

I-V Operating Area

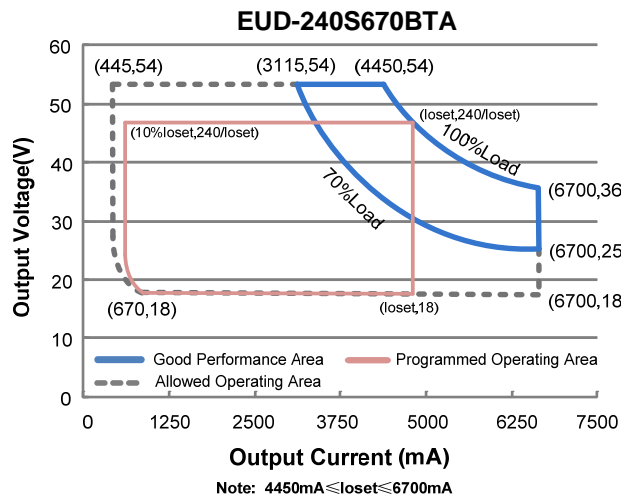
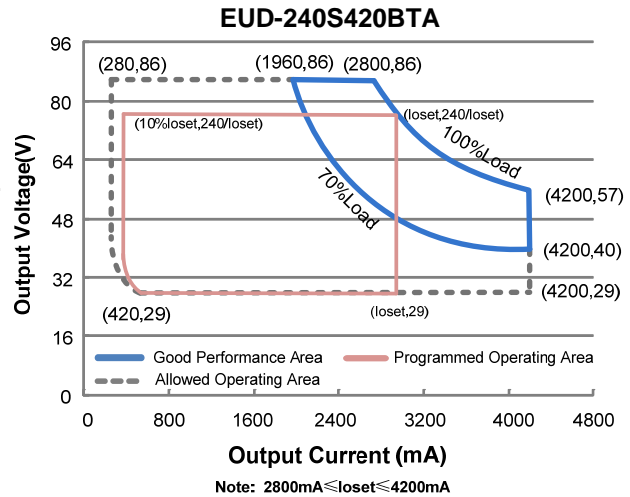
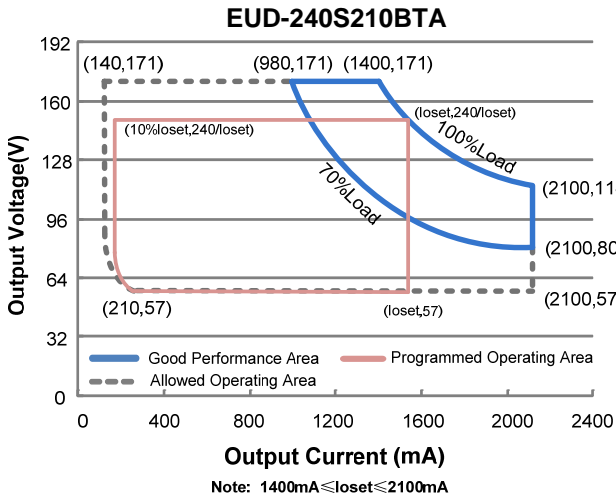
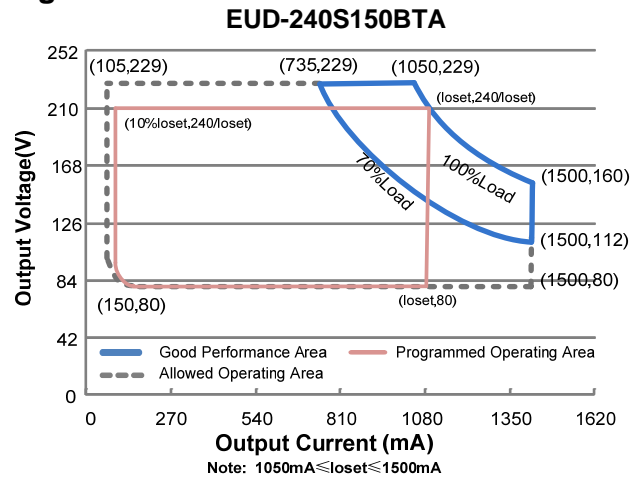
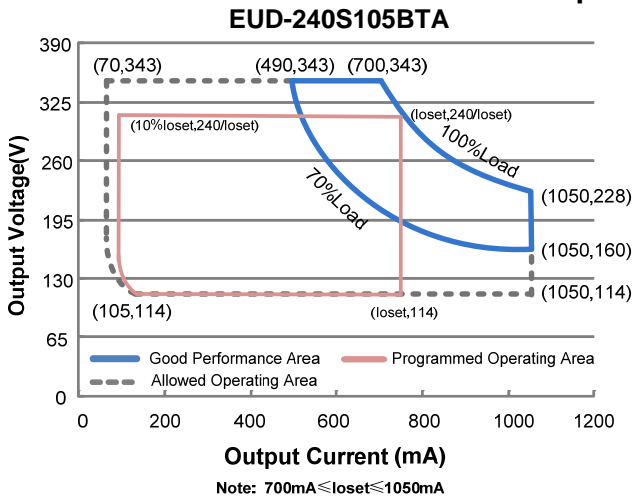

Input Specifications

Parameter	Min.	Typ.	Max.	Notes
Input Voltage	90 Vac	-	305 Vac	127-300Vdc
Input Frequency	47 Hz	-	63 Hz	
Leakage Current	-	-	0.75 MIU	UL8750; 277Vac/ 60Hz, grounding effectively
	-	-	0.70 mA	IEC60598-1; 240Vac/ 60Hz, grounding effectively
Input AC Current	-	-	3.00 A	Measured at full load and 100 Vac input.
	-	-	1.30 A	Measured at full load and 220 Vac input.
Inrush Current(I ² t)	-	-	2.60 A ² s	At 220Vac input, 25 °C cold start, duration=840µs, 10%Ipk-10%Ipk. See Inrush Current Waveform for the details.
PF	0.90	-	-	At 100-277Vac, 50-60Hz, 70%-100% Load (168-240W)
THD	-	-	20%	
THD	-	-	10%	At 220-240Vac, 50-60Hz, 75%-100% Load (180-240W)

Output Specifications

Parameter	Min.	Typ.	Max.	Notes
Output Current Tolerance	-5%loset	-	5%loset	At full load condition
Output Current Setting(loset) Range				
EUD-240S105BTA	70 mA	-	1050 mA	
EUD-240S150BTA	105 mA	-	1500 mA	
EUD-240S210BTA	140 mA	-	2100 mA	
EUD-240S420BTA	280 mA	-	4200 mA	
EUD-240S670BTA	445 mA	-	6700 mA	
Output Current Setting Range with Constant Power				
EUD-240S105BTA	700 mA	-	1050 mA	
EUD-240S150BTA	1050 mA	-	1500 mA	
EUD-240S210BTA	1400 mA	-	2100 mA	
EUD-240S420BTA	2800 mA	-	4200 mA	
EUD-240S670BTA	4450 mA	-	6700 mA	
Total Output Current Ripple (pk-pk)	-	5%lomax	10%lomax	At full load condition, 20 MHz BW
Output Current Ripple at < 200 Hz (pk-pk)	-	2%lomax	-	At full load condition. Only this component of ripple is associated with visible flicker.
Startup Overshoot Current	-	-	10%lomax	At full load condition
No Load Output Voltage				
EUD-240S105BTA	-	-	360 V	
EUD-240S150BTA	-	-	260 V	
EUD-240S210BTA	-	-	190 V	
EUD-240S420BTA	-	-	96 V	
EUD-240S670BTA	-	-	66 V	
Line Regulation	-	-	±0.5%	Measured at full load

Output Specifications (Continued)

Parameter	Min.	Typ.	Max.	Notes
Load Regulation	-	-	± 1.5%	
Turn-on Delay Time	-	-	1.0 s	Measured at 120Vac input, 70%-100% Load
	-	-	0.5 s	Measured at 220Vac input, 70%-100% Load
Temperature Coefficient of I _o set	-	0.03%/°C	-	Case temperature = 0°C ~T _c max
12V Auxiliary Output Voltage	10.8 V	12 V	13.2 V	
12V Auxiliary Output Source Current	0 mA	-	200 mA	Return terminal is "OTP-"
12V Auxiliary Output Transient Peak Current	-	-	400 mA	400mA peak for a maximum duration of 300ms in a 2s period during which time the average should not exceed 200mA.

Note: All specifications are typical at 25°C unless otherwise stated.

General Specifications

Parameter	Min.	Typ.	Max.	Notes
Efficiency at 120 Vac input:				Measured at full load and steady-state temperature in 25°C ambient; (Efficiency will be about 2.0% lower if measured immediately after startup.)
EUD-240S105BTA				
I _o = 700 mA	89.0%	91.0%	-	
I _o =1050 mA	88.0%	90.0%	-	
EUD-240S150BTA				
I _o =1050 mA	88.0%	90.0%	-	
I _o =1500 mA	87.0%	89.0%	-	
EUD-240S210BTA				
I _o =1400 mA	89.0%	91.0%	-	
I _o =2100 mA	87.5%	89.5%	-	
EUD-240S420BTA				
I _o =2800 mA	88.5%	90.5%	-	
I _o =4200 mA	87.0%	89.0%	-	
EUD-240S670BTA				
I _o =4450 mA	89.0%	91.0%	-	
I _o =6700 mA	87.0%	89.0%	-	
Efficiency at 220 Vac input:				Measured at full load and steady-state temperature in 25°C ambient; (Efficiency will be about 2.0% lower if measured immediately after startup.)
EUD-240S105BTA				
I _o = 700 mA	92.0%	94.0%	-	
I _o =1050 mA	90.5%	92.5%	-	
EUD-240S150BTA				
I _o =1050 mA	91.0%	93.0%	-	
I _o =1500 mA	89.5%	91.5%	-	
EUD-240S210BTA				
I _o =1400 mA	91.5%	93.5%	-	
I _o =2100 mA	90.0%	92.0%	-	
EUD-240S420BTA				
I _o =2800 mA	91.0%	93.0%	-	
I _o =4200 mA	89.5%	91.5%	-	
EUD-240S670BTA				
I _o =4450 mA	91.0%	93.0%	-	
I _o =6700 mA	89.0%	91.0%	-	

General Specifications (Continued)

Parameter	Min.	Typ.	Max.	Notes
Efficiency at 277 Vac input: EUD-240S105BTA I _o = 700 mA I _o =1050 mA EUD-240S150BTA I _o =1050 mA I _o =1500 mA EUD-240S210BTA I _o =1400 mA I _o =2100 mA EUD-240S420BTA I _o =2800 mA I _o =4200 mA EUD-240S670BTA I _o =4450 mA I _o =6700 mA	92.0% 91.0% 91.5% 90.0% 92.0% 90.5% 91.5% 90.0% 91.5% 89.0%	94.0% 93.0% 93.5% 92.0% 94.0% 92.5% 93.5% 92.0% 93.5% 91.0%	- - - - - - - - - -	Measured at full load and steady-state temperature in 25°C ambient; (Efficiency will be about 2.0% lower if measured immediately after startup.)
Standby power	-	-	0.5 W	Measured at 230Vac/50Hz; Dimming off
MTBF	-	228,000 Hours	-	Measured at 220Vac input, 80%Load and 25°C ambient temperature (MIL-HDBK-217F)
Lifetime	-	96,000 Hours	-	Measured at 220Vac input, 80%Load and 70°C case temperature; See lifetime vs. T _c curve for the details
Operating Case Temperature for Safety T _{c_s}	-40°C	-	+87°C	
Operating Case Temperature for Warranty T _{c_w}	-40°C	-	+75°C	Case temperature for 7 years warranty. Please see Inventronics Warranty Statement for complete details.
Storage Temperature	-40°C	-	+85°C	Humidity: 5%RH to 100%RH
Dimensions Inches (L × W × H) Millimeters (L × W × H)	8.63 × 2.66 × 1.57 219 × 67.5 × 39.7			With mounting ear 9.45 × 2.66 × 1.57 240 × 67.5 × 39.7
Net Weight	-	1300 g	-	

Note: All specifications are typical at 25°C unless otherwise stated.

Dimming Specifications

Parameter	Min.	Typ.	Max.	Notes
DA, DA High Level	9.5V	16V	22.5V	
DA, DA Low Level	-6.5V	0V	6.5V	
DA, DA Current	0mA	-	2mA	

Dimming Specifications (Continued)

Parameter		Min.	Typ.	Max.	Notes
Dimming Output Range	EUD-240S105BTA EUD-240S150BTA EUD-240S210BTA EUD-240S420BTA EUD-240S670BTA	10%loset	-	loset	700 mA ≤ loset ≤ 1050 mA 1050 mA ≤ loset < 1500 mA 1400 mA ≤ loset ≤ 2100 mA 2800 mA ≤ loset ≤ 4200 mA 4450 mA ≤ loset ≤ 6700 mA
	EUD-240S105BTA EUD-240S150BTA EUD-240S210BTA EUD-240S420BTA EUD-240S670BTA	70 mA 105 mA 140 mA 280 mA 445 mA	-	loset	70 mA ≤ loset < 700 mA 105 mA ≤ loset < 1050 mA 140 mA ≤ loset < 1400 mA 280 mA ≤ loset < 2800 mA 445 mA ≤ loset < 4450 mA

Note: All specifications are typical at 25 °C unless stated otherwise.

Standards Compliance

Safety Category	Standard
UL/CUL	UL8750,CAN/CSA-C22.2 No. 250.13
CE	EN 61347-1, EN61347-2-13
KS	KS C 7655
EMI Standards	Notes
EN 55015 ⁽¹⁾	Conducted emission Test & Radiated emission Test
EN 61000-3-2	Harmonic current emissions
EN 61000-3-3	Voltage fluctuations & flicker
FCC Part 15 ⁽¹⁾	ANSI C63.4 Class B
	This device complies with Part 15 of the FCC Rules. Operation is subject to the following two conditions: [1] this device may not cause harmful interference, and [2] this device must accept any interference received, including interference that may cause undesired Operation.
EMS Standards	Notes
EN 61000-4-2	Electrostatic Discharge (ESD): 8 kV air discharge, 4 kV contact discharge
EN 61000-4-3	Radio-Frequency Electromagnetic Field Susceptibility Test-RS
EN 61000-4-4	Electrical Fast Transient / Burst-EFT
EN 61000-4-5	Surge Immunity Test: AC Power Line: line to line 6 kV, line to earth 10 kV ⁽²⁾
EN 61000-4-6	Conducted Radio Frequency Disturbances Test-CS
EN 61000-4-8	Power Frequency Magnetic Field Test
EN 61000-4-11	Voltage Dips
EN 61547	Electromagnetic Immunity Requirements Applies To Lighting Equipment
DALI Standards	Notes
DALI	IEC62386-101,102 & part of 207 ⁽³⁾

Note: (1) This LED driver meets the EMI specifications above, but EMI performance of a luminaire that contains it depends also on the other devices connected to the driver and on the fixture itself.

- (2) To perform electric strength (hi-pot) testing, the “GDT ground disconnect” (nut and metal lock sheet) on the driver end-cap should be removed temporarily to prevent the internal gas discharge tube from conducting (as allowed by IEC 60598-1 Clause 10.2). After testing is completed, these items must be reinstalled to restore line-to-earth surge protection and secure the end cap.
- (3) Optional Commands Implemented: 242 (query short circuit), 243 (query open circuit)

Derating

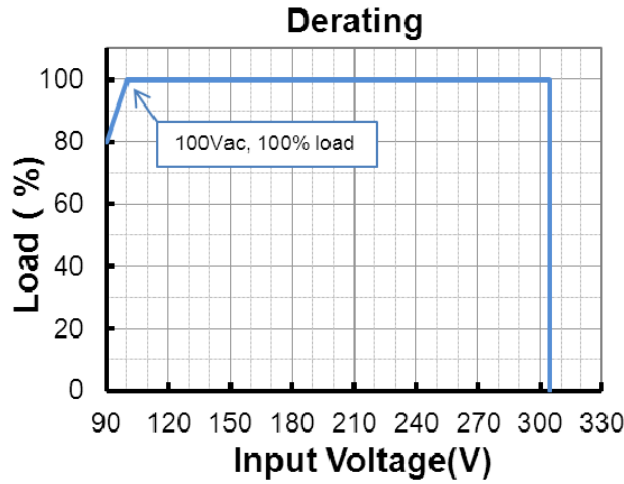

Lifetime vs. Case Temperature

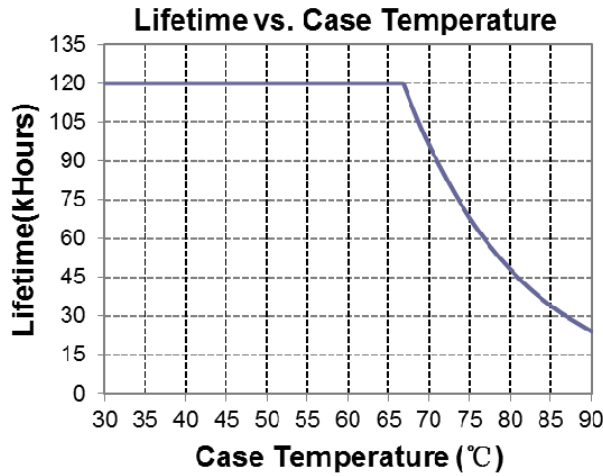

Inrush Current Waveform

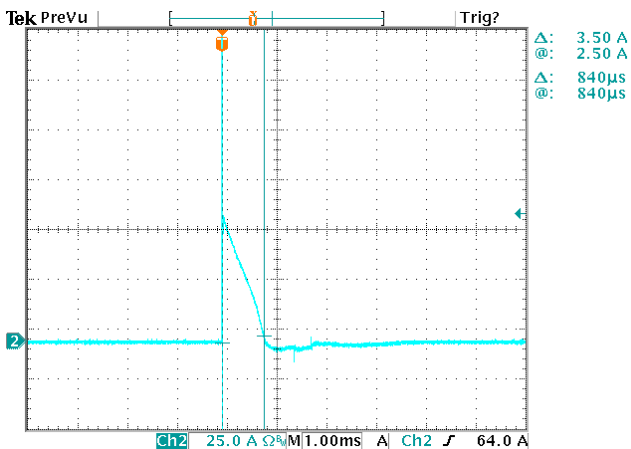

Efficiency vs. Load

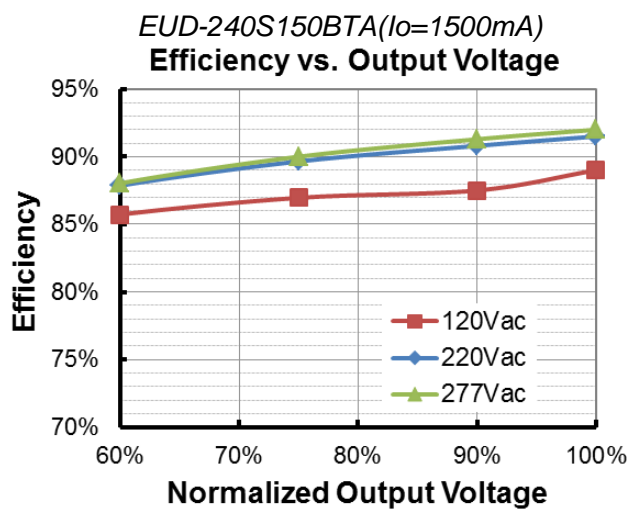
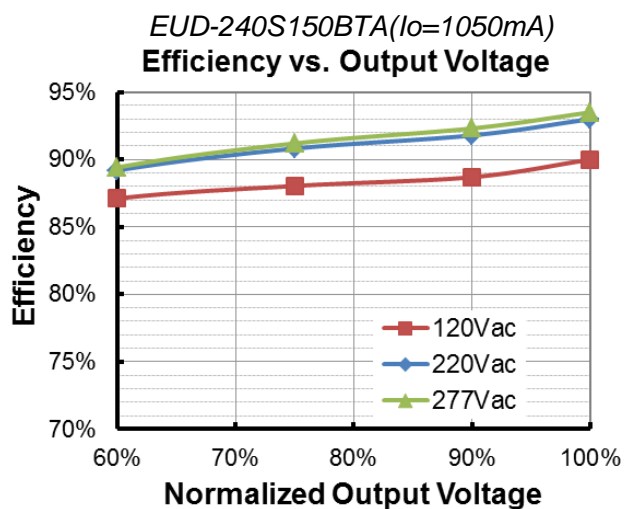
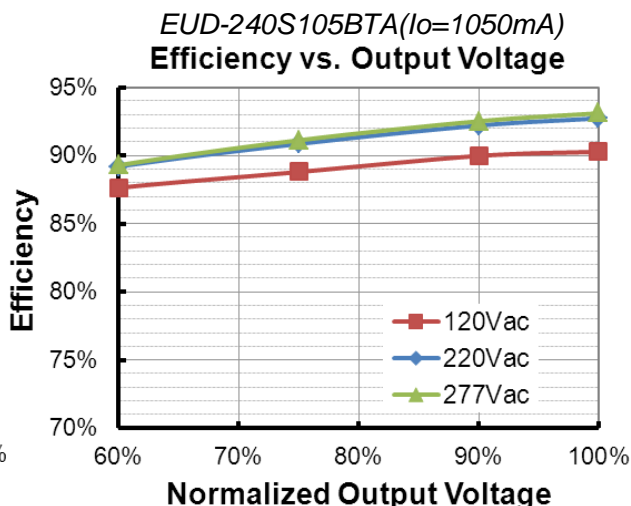
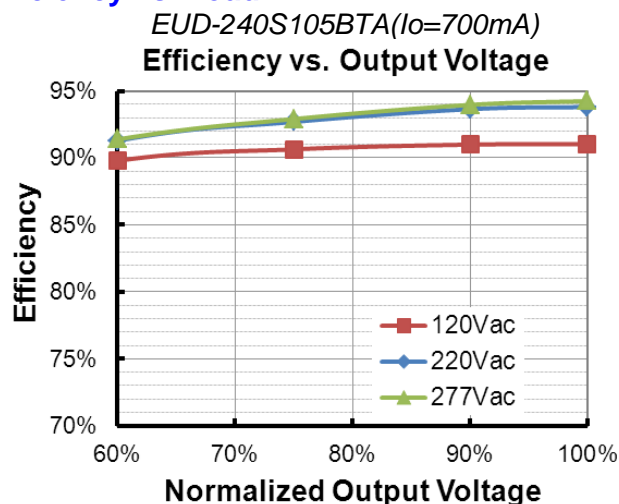

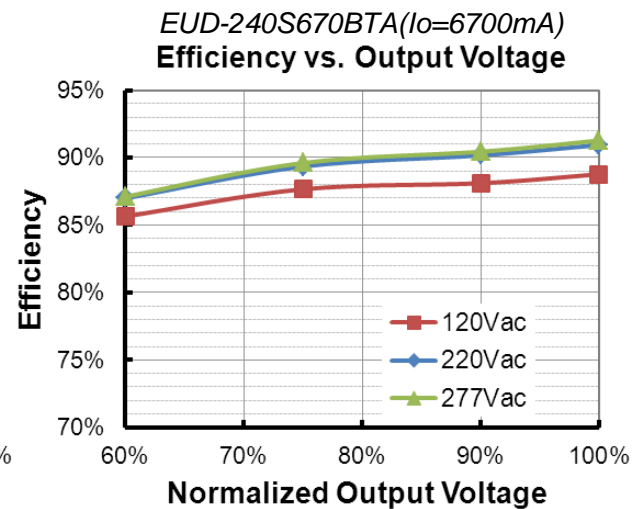
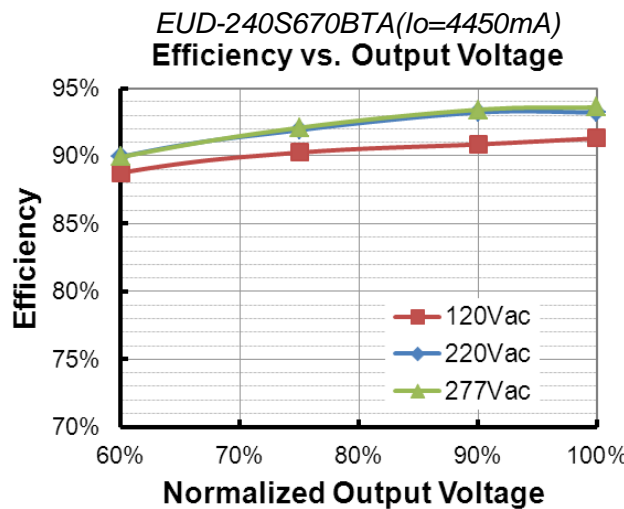
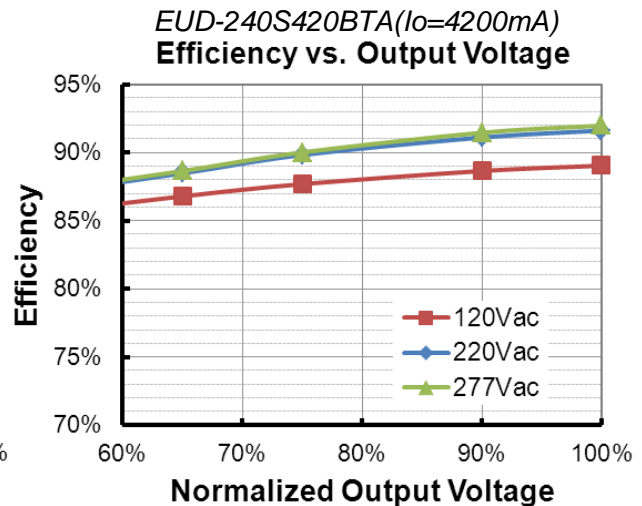
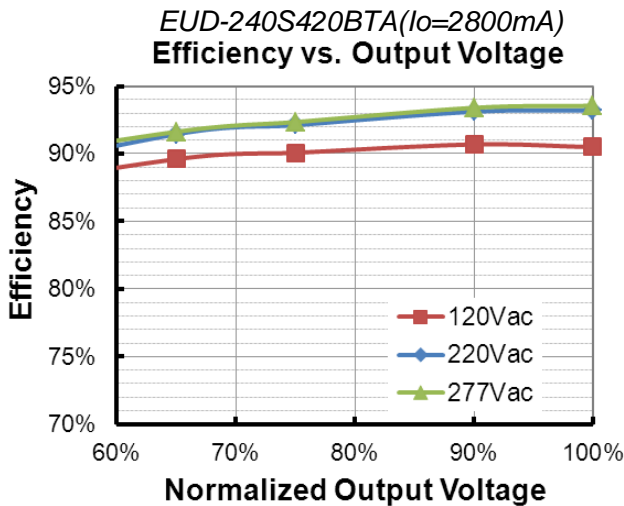
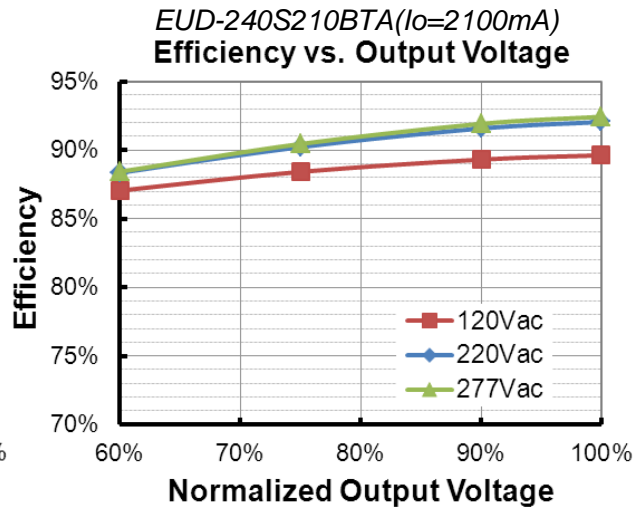
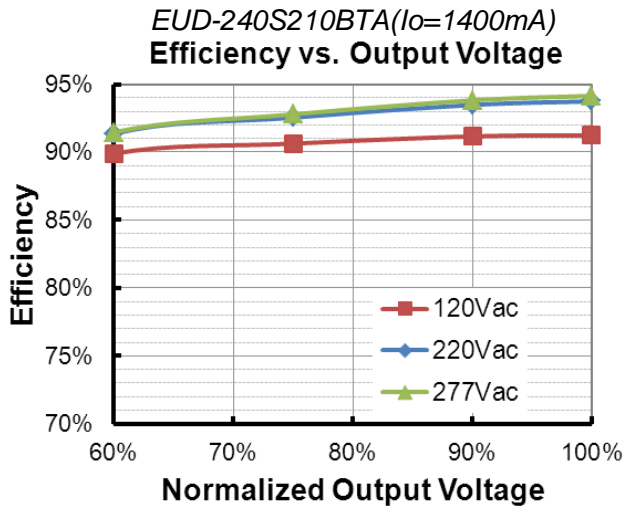

Power Factor

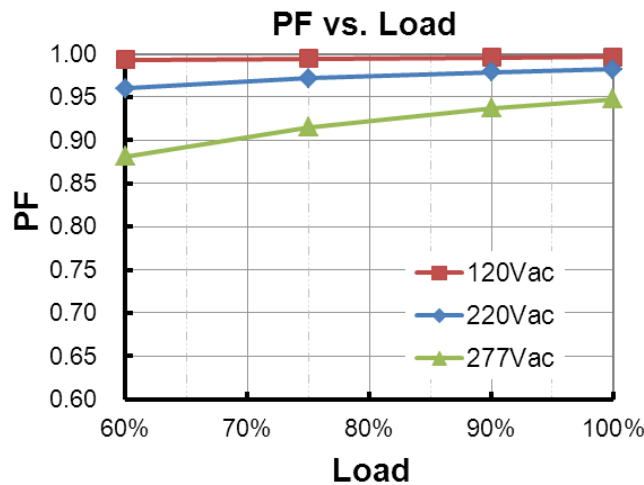

Total Harmonic Distortion

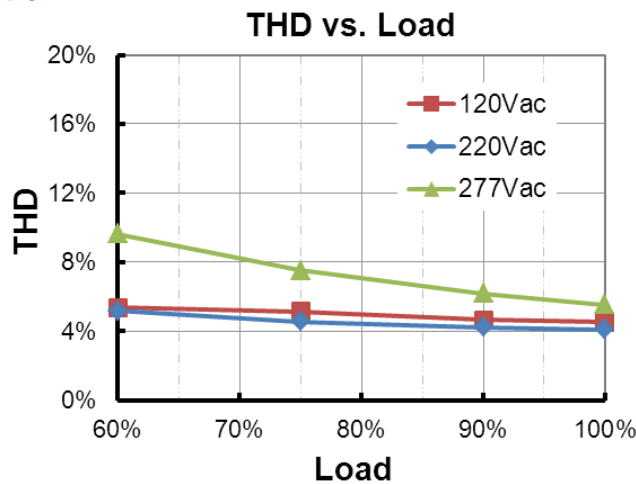

Protection Functions

Parameter		Min.	Typ.	Max.	Notes
External Thermal Protection NTC	R1	-	7.81 kOhm	-	When R_NTC falls below R1, External Thermal Protection is triggered, reducing output current until R2 is reached.
	R2	-	4.16 kOhm	-	When R_NTC is less than R2, output current is reduced to the programmed "Protection Current Floor."
	Protection Current Floor	10%loset	60%loset	100%loset	10%loset > Iomin (default setting is 60%)
Iomin		60%loset	100%loset	10%loset ≤ Iomin (default setting is 60%)	
Over Temperature Protection		Decreases output current, returning to normal after over temperature is removed.			
Short Circuit Protection		Auto Recovery. No damage will occur when any output is short circuited. The output shall return to normal when the fault condition is removed.			
Over Voltage Protection		Limits output voltage at no load and in case the normal voltage limit fails.			

Dimming

● DALI Dimming

The recommended implementation of the dimming control is provided below.

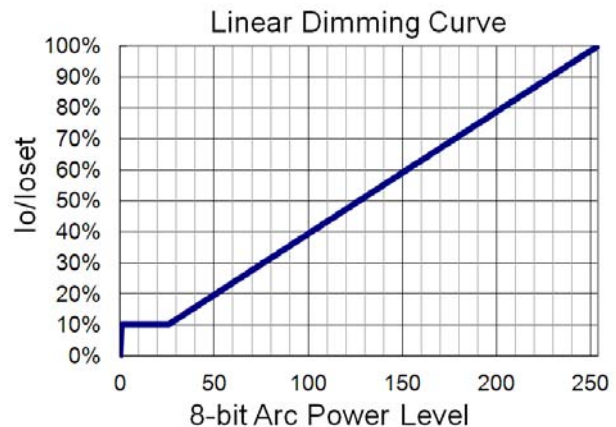
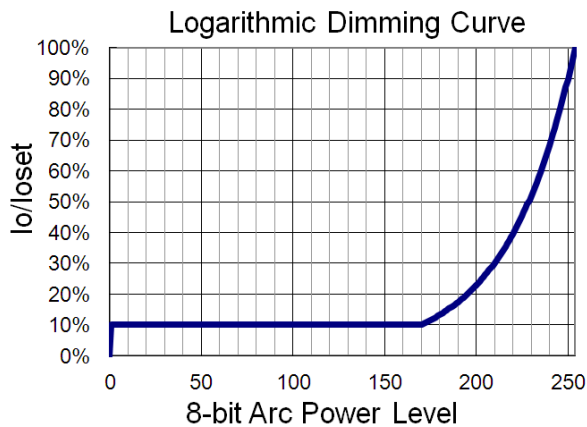
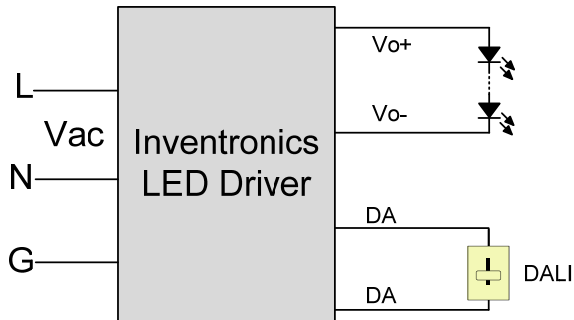

Implementation: DALI Dimming

● Time Dimming

Time dimming control includes 3 kinds of modes, they are Self Adapting-Midnight, Self Adapting-Percentage and Traditional Timer.

- **Self Adapting-Midnight:** Automatically adjusts the dimming curve based on the on-time of past two days (if difference <15 minutes), assuming that the center point of the dimming curve is midnight local time.
- **Self Adapting-Percentage:** Automatically adjusts the on-time of each step by a constant percentage = (actual on-time for the past 2 days if difference <15 min) / (programmed on-time from the dimming curve).
- **Traditional Timer:** Follows the programmed timing curve after power on with no changes.

● Output Lumen Compensation

Output Lumen Compensation (OLC) may be used to maintain constant light output over the life of the LEDs by driving them at a reduced current when new, then gradually increasing the drive current over time to counteract LED lumen degradation.

Programming Connection Diagram

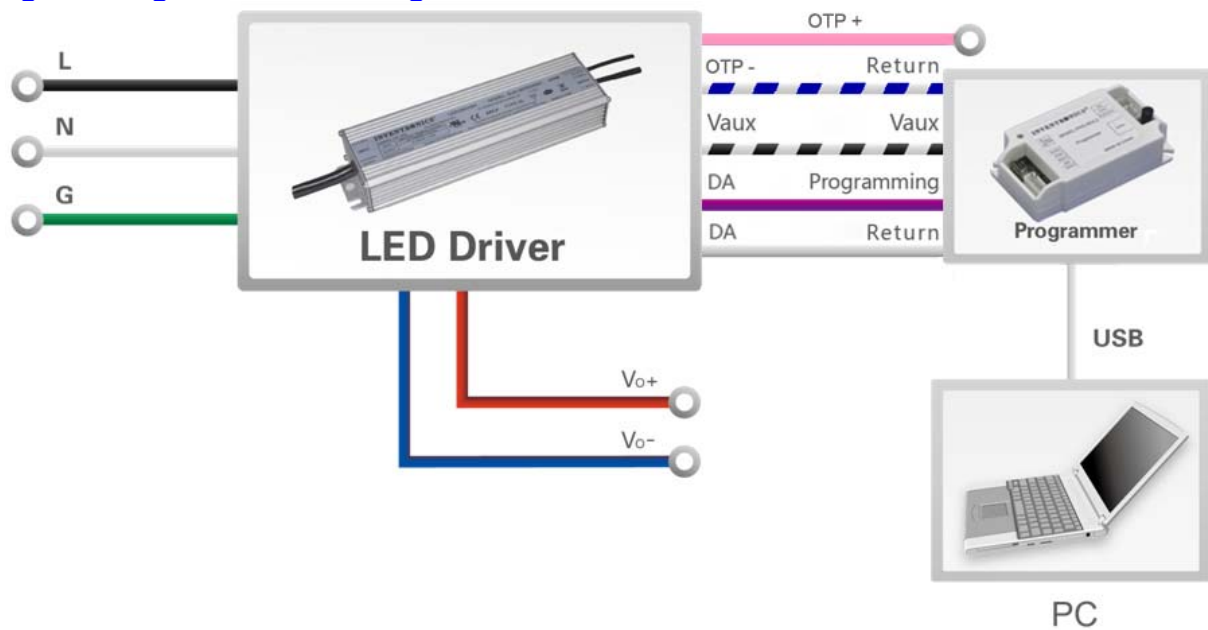

Note: (1) The driver does not need to be powered on during the programming process.

(2) Both "OTP-" and "DA" (gray) should be connected to "Return" of the programmer when programming.

- Please refer to [PRG-MUL2](#) (Programmer) datasheet for details.

Mechanical Outline

EUD-240S105BTA

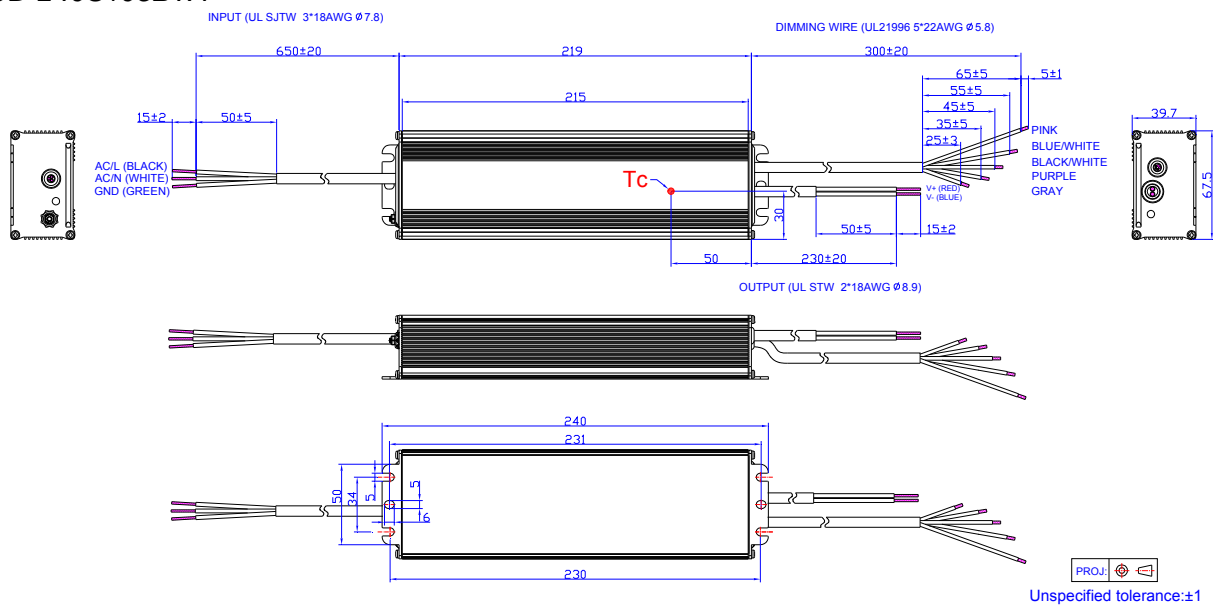

Others

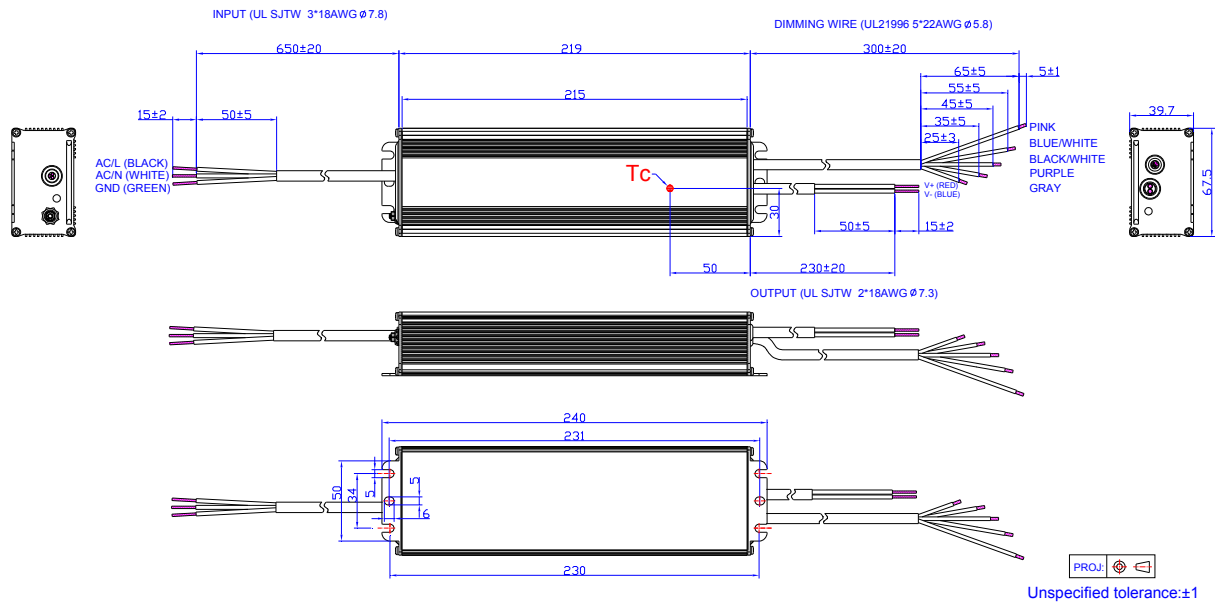

RoHS Compliance

Our products comply with the European Directive 2011/65/EC, calling for the elimination of lead and other hazardous substances from electronic products.

Revision History

Change Date	Rev.	Description of Change		
		Item	From	To
2017-03-07	A	Datasheets Release	/	/
2017-08-21	B	EUD-240S150BTA	/	Added
		Input Specifications	PF/THD	Updated
		Temperature Coefficient of loset	/	Updated
2017-10-26	C	Features	7 Years Warranty	Added
		General Specifications	Operating Case Temperature for Warranty Tc_w	Updated
2018-01-30	D	Description	/	Updated
		General Specifications	Lifetime	Updated
		Operating Case Temperature for Warranty Tc_w	+70°C	+75°C
		Lifetime vs. Case Temperature	/	Updated