

Features

- Ultra High Efficiency (Up to 95%)
- Full Power at Wide Output Current Range (Constant Power)
- Thermal Sensing and Protection for LED Module
- DALI/3-Timer-Modes Dimmable
- Dim-to-Off with Standby Power ≤ 0.5 W
- Always-on Auxiliary Power: 12Vdc, 200mA
- Output Lumen Compensation
- Input Surge Protection: DM 6kV, CM 10kV
- All-Around Protection: OVP, SCP, OTP
- IP67 and UL Dry / Damp / Wet Location
- SELV Output
- TYPE HL, for use in a Class I, Division 2 hazardous (Classified) location
- 7 Years Warranty



Description

The EUD-600SxxxBT series is a 600W, constant-current, programmable LED driver that operates from 90-305 Vac input with excellent power factor. Created for many lighting applications including high bay, sports and horticultural, it provides a dim-to-off mode with low standby power. The high efficiency of these drivers and compact metal case enables them to run cooler, significantly improving reliability and extending product life. To ensure trouble-free operation, protection is provided against input surge, output over voltage, short circuit, and over temperature.

Models

Adjustable Output Current Range	Full-Power Current Range (1)	Default Output Current	Input Voltage Range(2)	Output Voltage Range	Max. Output Power	Typical Efficiency (3)	Typical Power Factor		Model Number
							120Vac	220Vac	
0.11–1.40A	1.10–1.40A	1.4 A	90~305Vac/ 127~300Vdc	214 ~ 545Vdc	600 W	94.5%	0.99	0.96	EUD-600S140BT
0.224-2.80A	2.24–2.80A	2.8 A	90~305Vac/ 127~300Vdc	108 ~ 268Vdc	600 W	95.0%	0.99	0.96	EUD-600S280BT
0.336-4.20A	3.36–4.20A	4.2 A	90~305Vac/ 127~300Vdc	72 ~ 178Vdc	600 W	94.5%	0.99	0.96	EUD-600S420BT
0.448-5.60A	4.48–5.60A	5.6 A	90~305Vac/ 127~300Vdc	54 ~ 134Vdc	600 W	94.5%	0.99	0.96	EUD-600S560BT
0.592-7.40A	5.92–7.40A	7.0 A	90~305Vac/ 127~300Vdc	41 ~ 101Vdc	600 W	94.0%	0.99	0.96	EUD-600S740BT ⁽⁴⁾
0.784-9.80A	7.84–9.80A	9.8 A	90~305Vac/ 127~300Vdc	31 ~ 76Vdc	600 W	94.0%	0.99	0.96	EUD-600S980BT ⁽⁴⁾

Notes: (1) Output current range with constant power at 600W.

(2) Certified input voltage range: UL, FCC 100-277Vac or 127-300Vdc; otherwise: 100-240Vac or 127-250Vdc.

(3) Measured at 100% load and 220Vac input (see below “General Specifications” for details).

(4) SELV output.

I-V Operating Area

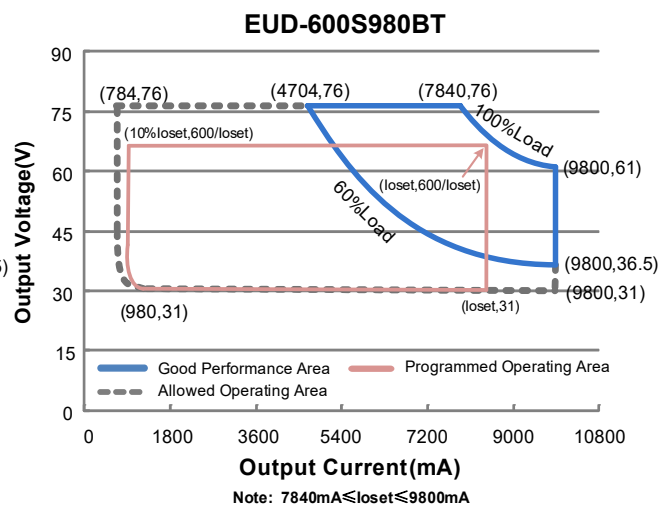
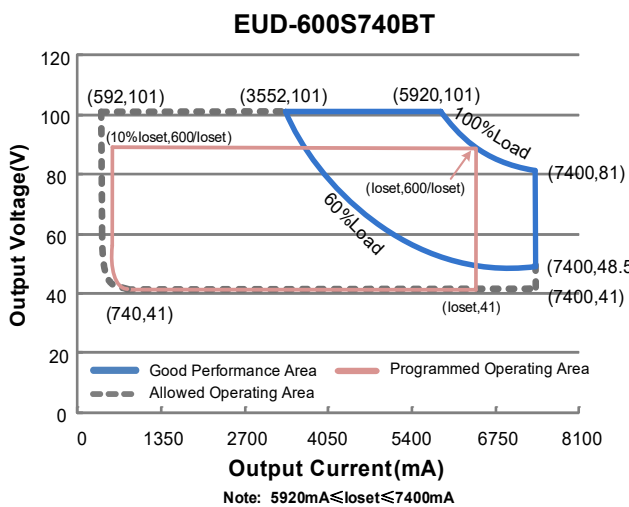
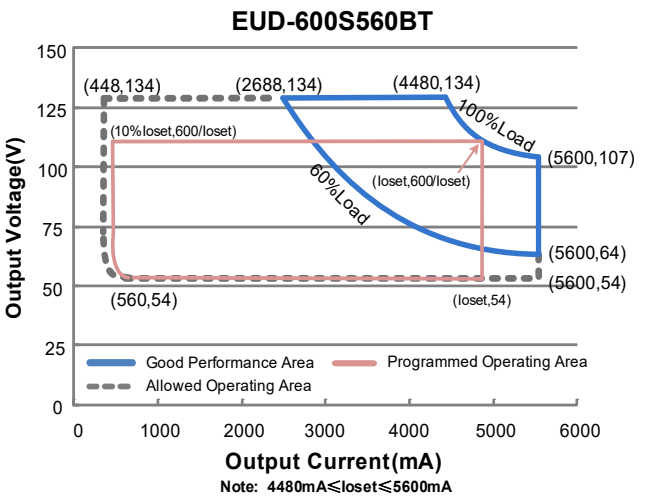
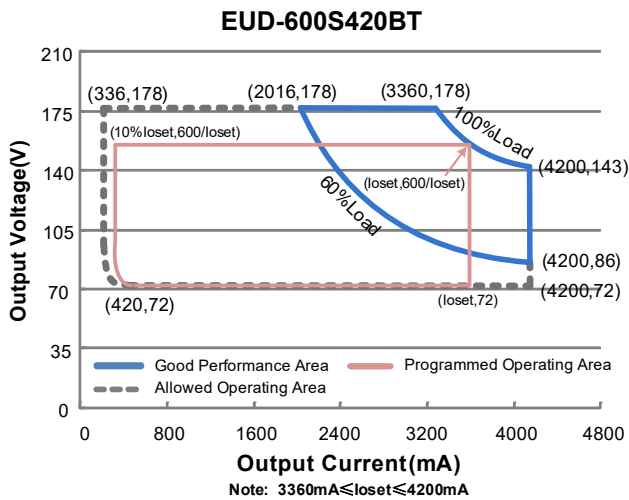
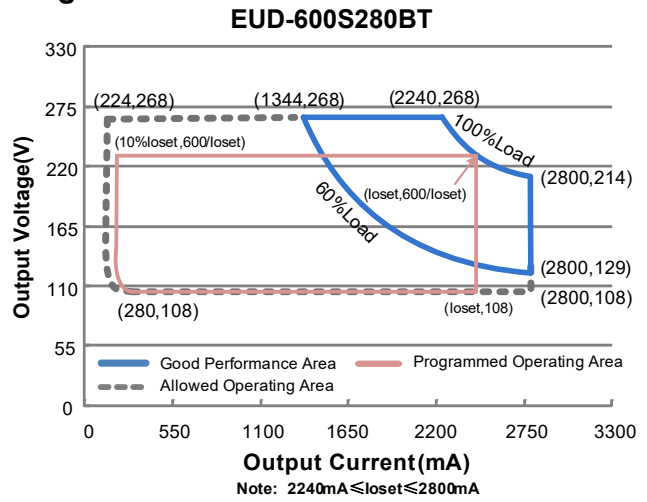
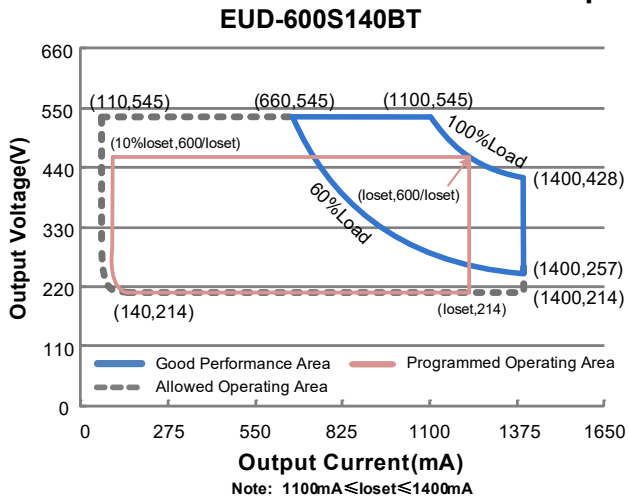

Input Specifications

Parameter	Min.	Typ.	Max.	Notes
Input AC Voltage	90 Vac	-	305 Vac	
Input DC Voltage	127 Vdc	-	300 Vdc	
Input Frequency	47 Hz	-	63 Hz	
Leakage Current	-	-	0.75 MIU	UL8750; 277Vac/ 60Hz, grounding effectively
	-	-	0.70 mA	IEC60598-1; 240Vac/ 60Hz, grounding effectively
Input AC Current	-	-	6.0 A	Measured at 100% load and 120 Vac input.
	-	-	3.5 A	Measured at 100% load and 220 Vac input.
Inrush Current(I ² t)	-	-	4.70 A ² s	At 220Vac input, 25°C cold start, duration=7.64 ms, 10%Ipk-10%Ipk. See Inrush Current Waveform for the details.
PF	0.90	-	-	At 100-277Vac, 50-60Hz, 60%-100% Load (360 - 600W)
THD	-	-	20%	
THD	-	-	10%	At 220-240Vac, 50-60Hz, 75%-100% Load (450 - 600W)

Output Specifications

Parameter	Min.	Typ.	Max.	Notes
Output Current Tolerance	-5%loset	-	5%loset	At 100% load condition
Output Current Setting(loset) Range				
EUD-600S140BT	110 mA	-	1400 mA	
EUD-600S280BT	224 mA	-	2800 mA	
EUD-600S420BT	336 mA	-	4200 mA	
EUD-600S560BT	448 mA	-	5600 mA	
EUD-600S740BT	592 mA	-	7400 mA	
EUD-600S980BT	784 mA	-	9800 mA	
Output Current Setting Range with Constant Power				
EUD-600S140BT	1100 mA	-	1400 mA	
EUD-600S280BT	2240 mA	-	2800 mA	
EUD-600S420BT	3360 mA	-	4200 mA	
EUD-600S560BT	4480 mA	-	5600 mA	
EUD-600S740BT	5920 mA	-	7400 mA	
EUD-600S980BT	7840 mA	-	9800 mA	
Total Output Current Ripple (pk-pk)	-	5%lomax	10%lomax	At 100% load condition, 20 MHz BW
Output Current Ripple at < 200 Hz (pk-pk)	-	2%lomax	-	At 100% load condition. Only this component of ripple is associated with visible flicker.
Startup Overshoot Current	-	-	10%lomax	At 100% load condition

Output Specifications (Continued)

Parameter	Min.	Typ.	Max.	Notes
No Load Output Voltage				
EUD-600S140BT	-	595 V	600 V	
EUD-600S280BT	-	290 V	295 V	
EUD-600S420BT	-	190 V	200 V	
EUD-600S560BT	-	150 V	155 V	
EUD-600S740BT	-	118 V	120 V	
EUD-600S980BT	-	87 V	95 V	
Line Regulation	-	-	±0.5%	Measured at 100% load
Load Regulation	-	-	±1.5%	
Turn-on Delay Time	-	-	1.0 s	Measured at 120Vac input, 60%-100% Load
	-	-	0.5 s	Measured at 220Vac input, 60%-100% Load
Temperature Coefficient of Isolet	-	0.03%/°C	-	Case temperature = 0°C ~Tc max
12V Auxiliary Output Voltage	10.8 V	12 V	13.2 V	
12V Auxiliary Output Source Current	0 mA	-	200 mA	Return terminal is "OTP"

General Specifications

Parameter	Min.	Typ.	Max.	Notes
Efficiency at 120 Vac input:				
EUD-600S140BT				
Io= 1100 mA	90.5%	92.5%	-	
Io= 1400 mA	90.0%	92.0%	-	
EUD-600S280BT				
Io= 2240 mA	91.0%	93.0%	-	
Io= 2800 mA	90.0%	92.0%	-	
EUD-600S420BT				
Io= 3360 mA	90.5%	92.5%	-	Measured at 100% load and steady-state temperature in 25°C ambient; (Efficiency will be about 2.0% lower if measured immediately after startup.)
Io= 4200 mA	89.5%	91.5%	-	
EUD-600S560BT				
Io= 4480 mA	90.0%	92.0%	-	
Io= 5600 mA	89.5%	91.5%	-	
EUD-600S740BT				
Io= 5920 mA	89.5%	91.5%	-	
Io= 7400 mA	89.0%	91.0%	-	
EUD-600S980BT				
Io= 7840 mA	90.0%	92.0%	-	
Io= 9800 mA	89.5%	91.5%	-	

General Specifications (Continued)

Parameter	Min.	Typ.	Max.	Notes	
Efficiency at 220 Vac input:					
EUD-600S140BT					
lo= 1100 mA	92.5%	94.5%	-		
lo= 1400 mA	92.0%	94.0%	-		
EUD-600S280BT					
lo= 2240 mA	93.0%	95.0%	-		
lo= 2800 mA	92.5%	94.5%	-		
EUD-600S420BT					
lo= 3360 mA	92.5%	94.5%	-	Measured at 100% load and steady-state temperature in 25°C ambient; (Efficiency will be about 2.0% lower if measured immediately after startup.)	
lo= 4200 mA	92.0%	94.0%	-		
EUD-600S560BT					
lo= 4480 mA	92.5%	94.5%	-		
lo= 5600 mA	92.0%	94.0%	-		
EUD-600S740BT					
lo= 5920 mA	92.0%	94.0%	-		
lo= 7400 mA	91.5%	93.5%	-		
EUD-600S980BT					
lo= 7840 mA	92.0%	94.0%	-		
lo= 9800 mA	91.0%	93.0%	-		
Efficiency at 277 Vac input:					
EUD-600S140BT					
lo= 1100 mA	93.0%	95.0%	-		
lo= 1400 mA	92.5%	94.5%	-		
EUD-600S280BT					
lo= 2240 mA	93.0%	95.0%	-		
lo= 2800 mA	92.5%	94.5%	-		
EUD-600S420BT					
lo= 3360 mA	93.0%	95.0%	-	Measured at 100% load and steady-state temperature in 25°C ambient; (Efficiency will be about 2.0% lower if measured immediately after startup.)	
lo= 4200 mA	92.0%	94.0%	-		
EUD-600S560BT					
lo= 4480 mA	93.0%	95.0%	-		
lo= 5600 mA	92.5%	94.5%	-		
EUD-600S740BT					
lo= 5920 mA	92.5%	94.5%	-		
lo= 7400 mA	91.5%	93.5%	-		
EUD-600S980BT					
lo= 7840 mA	92.5%	94.5%	-		
lo= 9800 mA	91.5%	93.5%	-		
Standby Power	-	-	0.5 W		Measured at 230Vac/50Hz; Dimming off
MTBF	-	200,000 Hours	-		Measured at 220Vac input, 80%Load and 25°C ambient temperature (MIL-HDBK-217F)
Lifetime	-	108,000 Hours	-		Measured at 220Vac input, 80%Load and 70°C case temperature; See lifetime vs. Tc curve for the details
Operating Case Temperature for Safety Tc_s	-40°C	-	+89°C		
Operating Case Temperature for Warranty Tc_w	-40°C	-	+75°C	Case temperature for 7 years warranty. Please see Inventronics Warranty Statement for complete details. Humidity: 10%RH to 95%RH	
Storage Temperature	-40°C	-	+85°C	Humidity: 5%RH to 95%RH	

General Specifications (Continued)

Parameter	Min.	Typ.	Max.	Notes
Dimensions Inches (L × W × H) Millimeters (L × W × H)		9.84 × 5.67 × 1.91 250 × 144 × 48.5		With mounting ear 10.83 × 5.67 × 1.91 275 × 144 × 48.5
Net Weight	-	3515 g	-	

Dimming Specifications

Parameter	Min.	Typ.	Max.	Notes	
DA, DA High Level	9.5V	16V	22.5V		
DA, DA Low Level	-6.5V	0V	6.5V		
DA, DA Current	0mA	-	2mA		
Dimming Output Range	EUD-600S140BT EUD-600S280BT EUD-600S420BT EUD-600S560BT EUD-600S740BT EUD-600S980BT	10%loset	-	loset	1100 mA ≤ loset ≤ 1400 mA 2240 mA ≤ loset ≤ 2800 mA 3360 mA ≤ loset ≤ 4200 mA 4480 mA ≤ loset ≤ 5600 mA 5920 mA ≤ loset ≤ 7400 mA 7840 mA ≤ loset ≤ 9800 mA
	EUD-600S140BT EUD-600S280BT EUD-600S420BT EUD-600S560BT EUD-600S740BT EUD-600S980BT	110 mA 224 mA 336 mA 448 mA 592 mA 784 mA	-	loset	110 mA ≤ loset < 1100 mA 224 mA ≤ loset < 2240 mA 336 mA ≤ loset < 3360 mA 448 mA ≤ loset < 4480 mA 592 mA ≤ loset < 5920 mA 784 mA ≤ loset < 7840 mA

Safety & EMC Compliance

Safety Category	Standard
UL/CUL	UL8750,CAN/CSA-C22.2 No. 250.13
CE	EN 61347-1, EN 61347-2-13
EMI Standards	Notes
EN 55015 ⁽¹⁾	Conducted emission Test & Radiated emission Test
EN 61000-3-2	Harmonic current emissions
EN 61000-3-3	Voltage fluctuations & flicker
FCC Part 15 ⁽¹⁾	ANSI C63.4 Class B
	This device complies with Part 15 of the FCC Rules. Operation is subject to the following two conditions: [1] this device may not cause harmful interference, and [2] this device must accept any interference received, including interference that may cause undesired Operation.
EMS Standards	Notes
EN 61000-4-2	Electrostatic Discharge (ESD): 8 kV air discharge, 4 kV contact discharge
EN 61000-4-3	Radio-Frequency Electromagnetic Field Susceptibility Test-RS

Safety & EMC Compliance (Continued)

EMS Standards	Notes
EN 61000-4-4	Electrical Fast Transient / Burst-EFT
EN 61000-4-5	Surge Immunity Test: AC Power Line: Differential Mode 6 kV, Common Mode 10 kV ⁽²⁾
EN 61000-4-6	Conducted Radio Frequency Disturbances Test-CS
EN 61000-4-8	Power Frequency Magnetic Field Test
EN 61000-4-11	Voltage Dips
EN 61547	Electromagnetic Immunity Requirements Applies To Lighting Equipment
DALI Standards	Notes
DALI	IEC62386-101,102 & part of 207 ⁽³⁾

- Notes:** (1) This LED driver meets the EMI specifications above, but EMI performance of a luminaire that contains it depends also on the other devices connected to the driver and on the fixture itself.
 (2) To perform electric strength (hi-pot) testing, the “GDT ground disconnect” (nut and metal lock sheet) on the driver end-cap should be removed temporarily to prevent the internal gas discharge tube from conducting (as allowed by IEC 60598-1 Clause 10.2). After testing is completed, these items must be reinstalled to restore line-to-earth surge protection and secure the end cap.
 (3) Optional Commands Implemented: 242 (query short circuit), 243 (query open circuit).

Derating

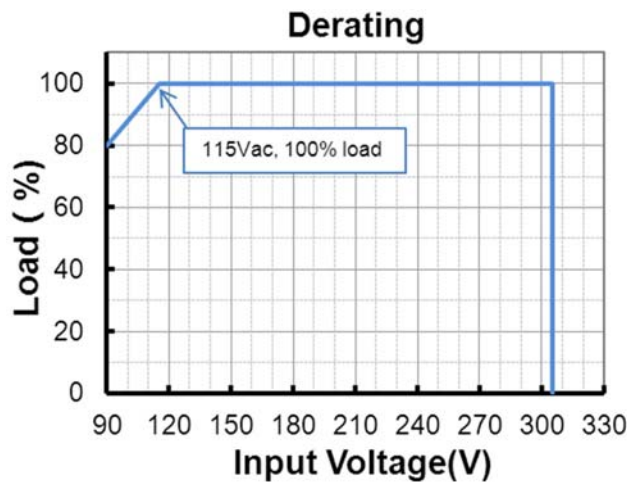

Lifetime vs. Case Temperature

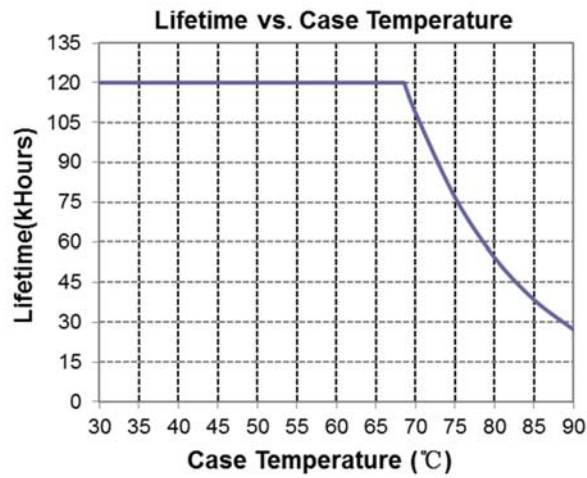

Inrush Current Waveform

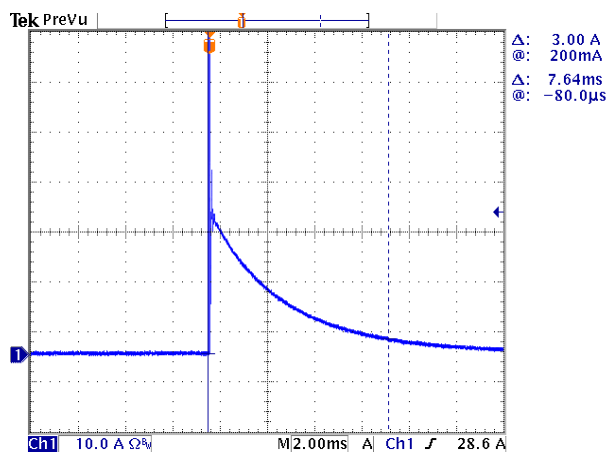

Efficiency vs. Load

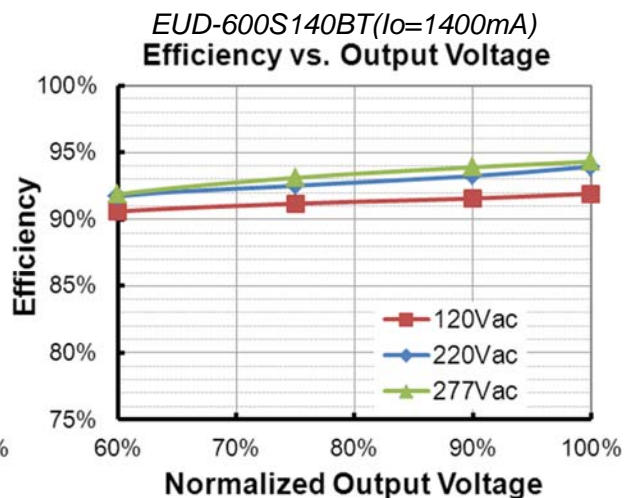
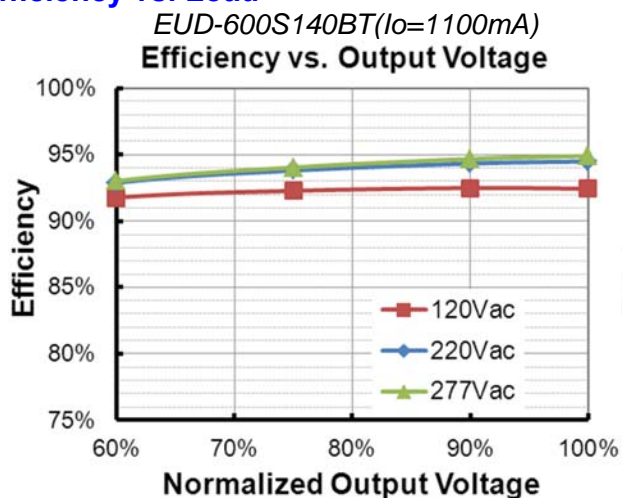

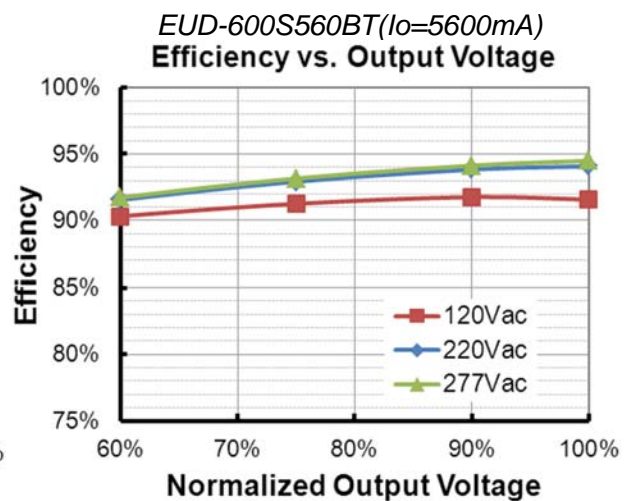
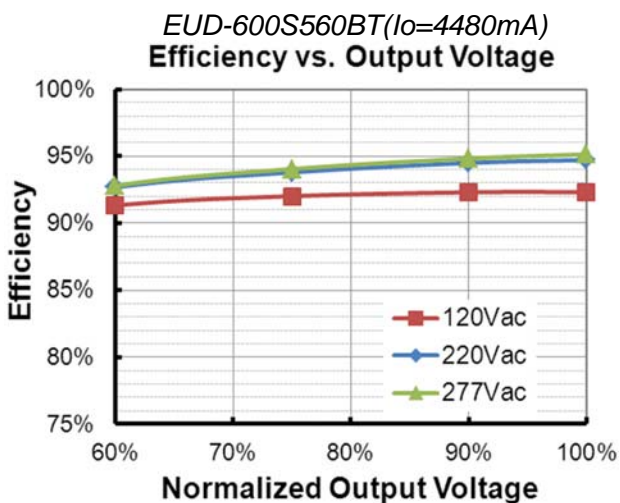
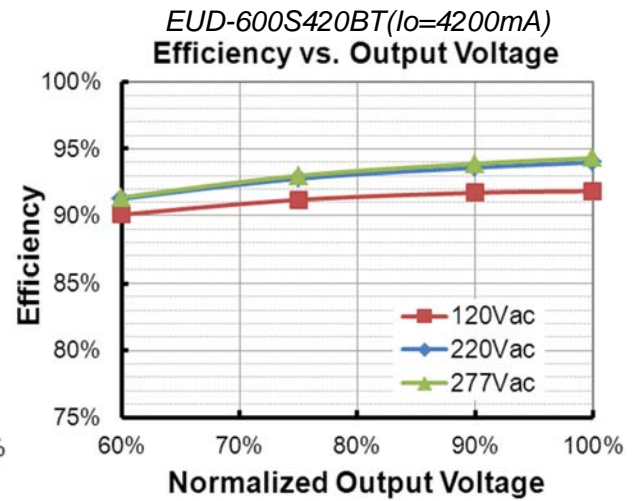
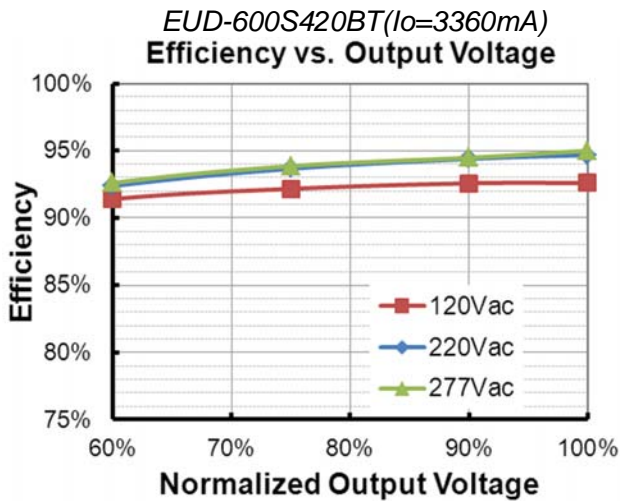
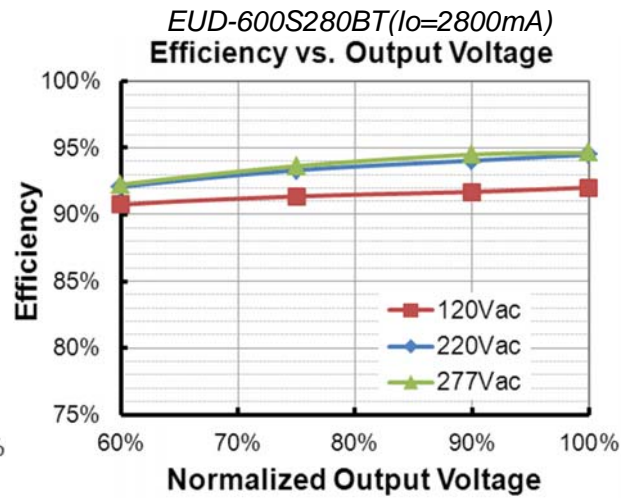
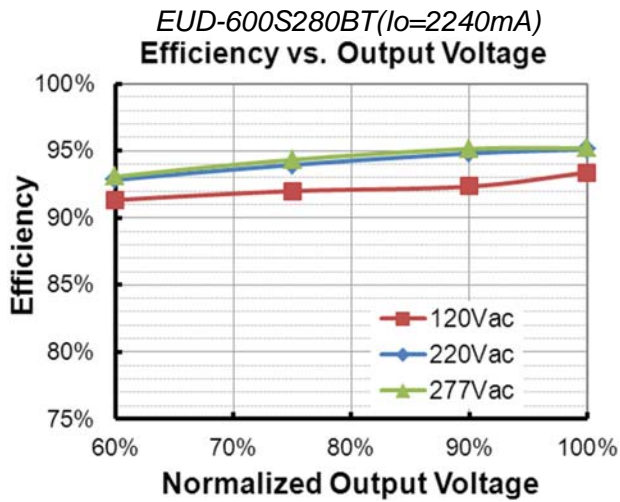

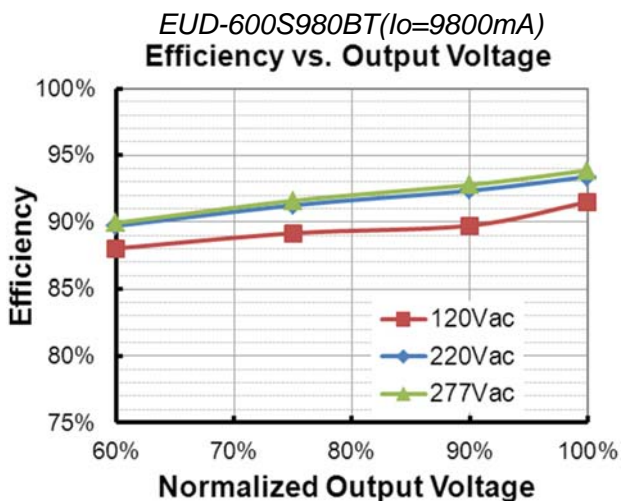
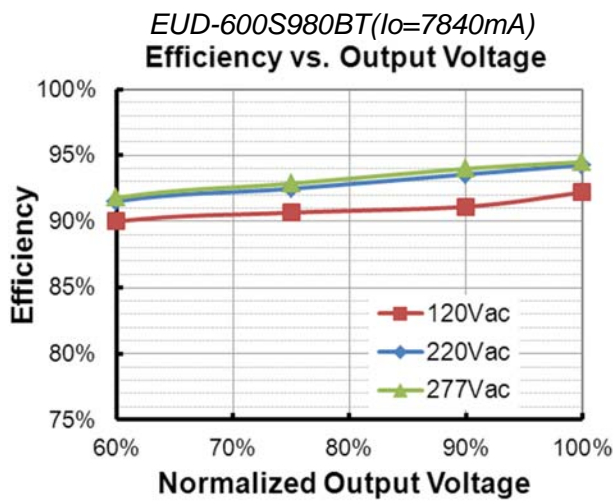
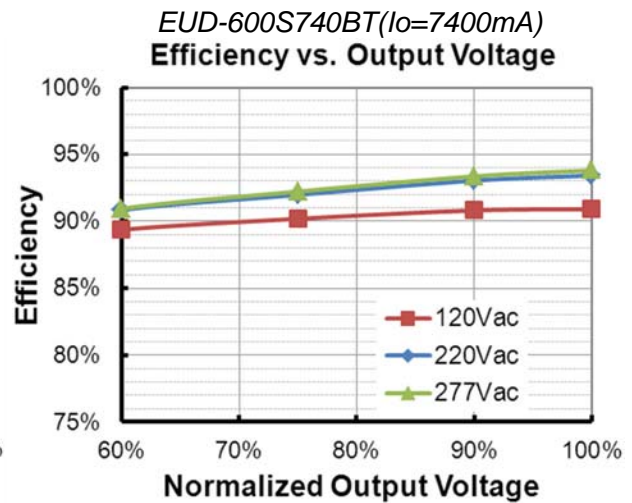
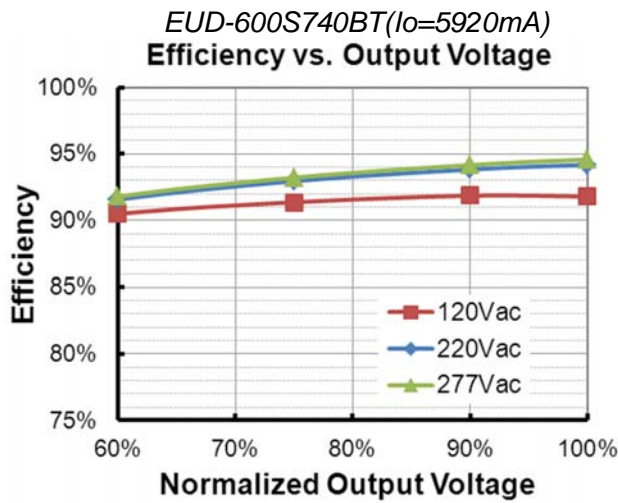

Power Factor

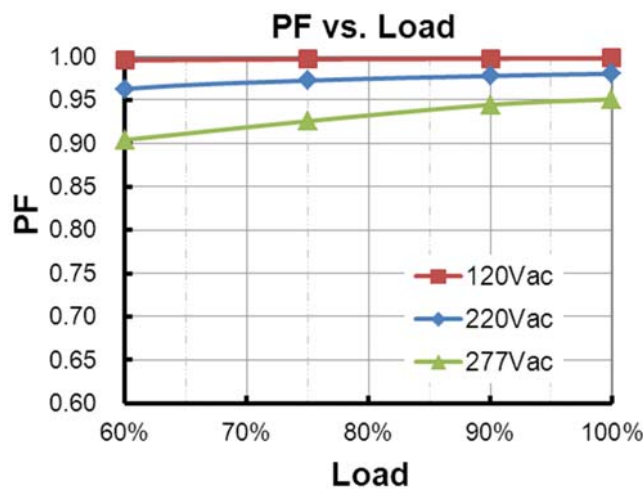

Total Harmonic Distortion

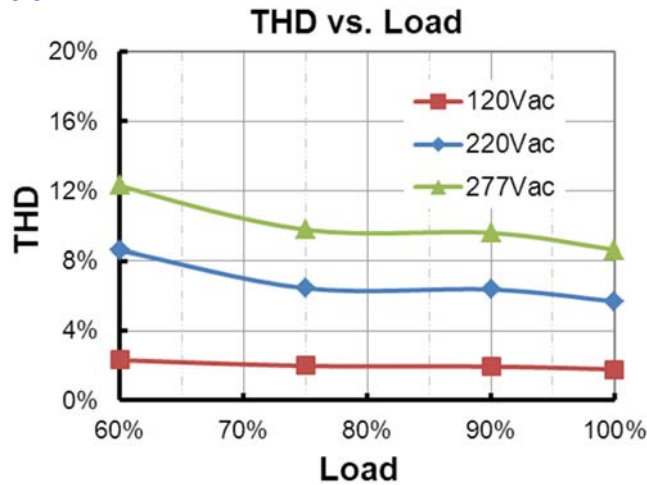

Protection Functions

Parameter		Min.	Typ.	Max.	Notes
External Thermal Protection NTC	R1	-	7.81 kOhm	-	When R_NTC falls below R1, External Thermal Protection is triggered, reducing output current until R2 is reached.
	R2	-	4.16 kOhm	-	When R_NTC is less than R2, output current is reduced to the programmed "Protection Current Floor."
	Protection Current Floor	10%loset	60%loset	100%loset	10%loset > Iomin (default setting is 60%)
		Iomin	60%loset	100%loset	10%loset ≤ Iomin (default setting is 60%)
Over Temperature Protection		Decreases output current, returning to normal after over temperature is removed.			
Short Circuit Protection		Auto Recovery. No damage will occur when any output is short circuited. The output shall return to normal when the fault condition is removed.			
Over Voltage Protection		Limits output voltage at no load and in case the normal voltage limit fails.			

Dimming

● DALI Dimming

The recommended implementation of the dimming control is provided below.

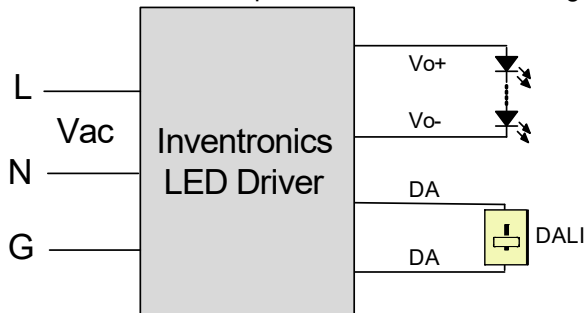

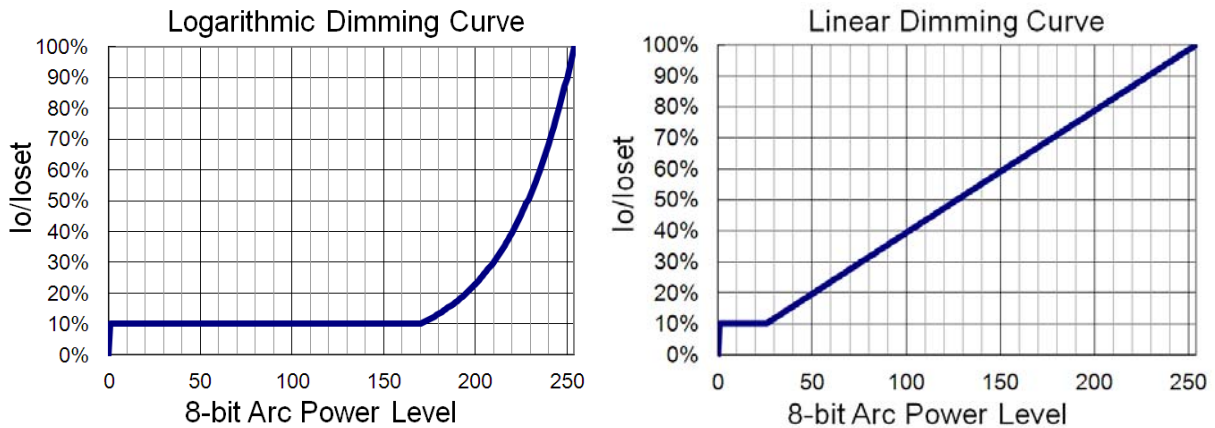

Implementation: DALI Dimming

● **Time Dimming**

Time dimming control includes 3 kinds of modes, they are Self Adapting-Midnight, Self Adapting-Percentage and Traditional Timer.

- **Self Adapting-Midnight:** Automatically adjusts the dimming curve based on the on-time of past two days (if difference <15 minutes), assuming that the center point of the dimming curve is midnight local time.
- **Self Adapting-Percentage:** Automatically adjusts the on-time of each step by a constant percentage = (actual on-time for the past 2 days if difference <15 min) / (programmed on-time from the dimming curve).
- **Traditional Timer:** Follows the programmed timing curve after power on with no changes.

● **Output Lumen Compensation**

Output Lumen Compensation (OLC) may be used to maintain constant light output over the life of the LEDs by driving them at a reduced current when new, then gradually increasing the drive current over time to counteract LED lumen degradation.

Programming Connection Diagram

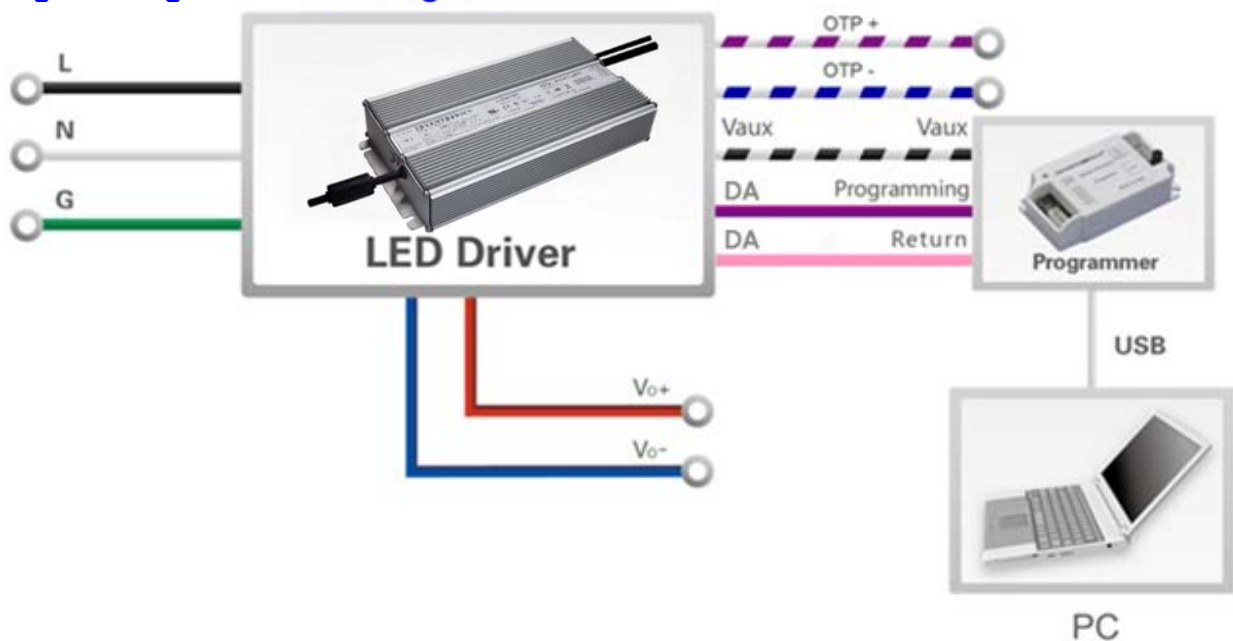

Note: (1) The driver does not need to be powered on during the programming process.
 (2) Both "OTP-" and "DA" (pink) should be connected to "Return" of the programmer when programming.

● Please refer to [PRG-MUL2 \(Programmer\)](#) datasheet for details.

Mechanical Outline

EUD-600S140BT

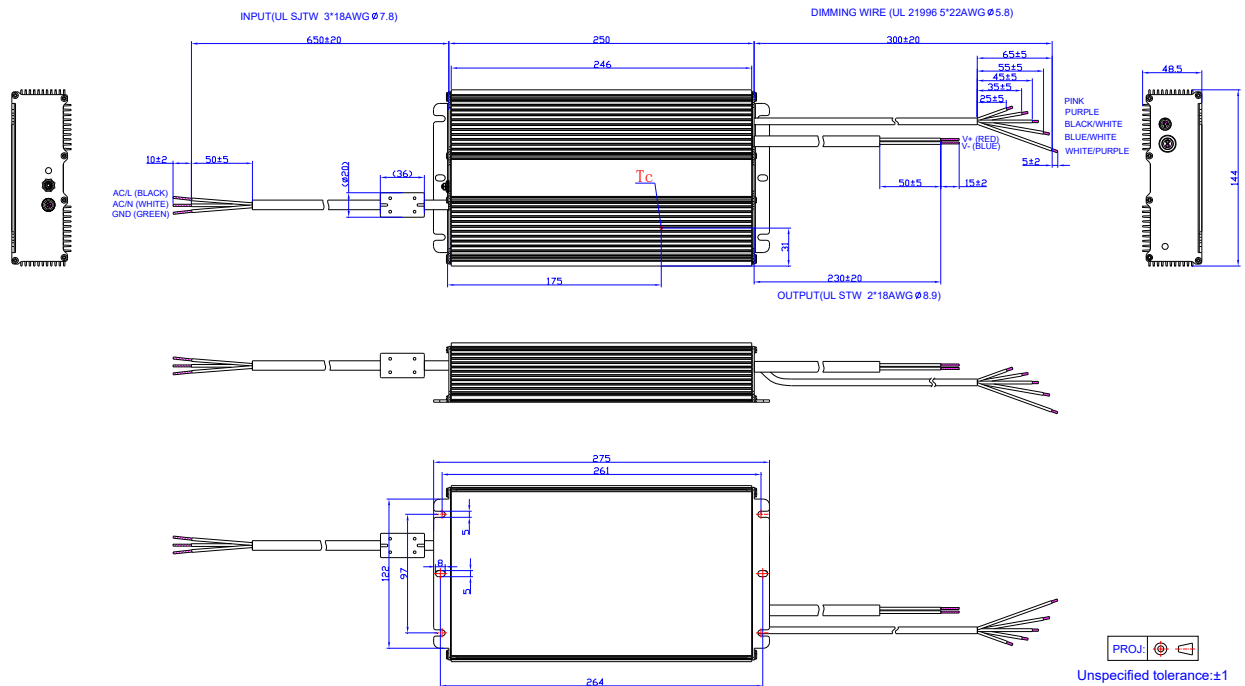

Others

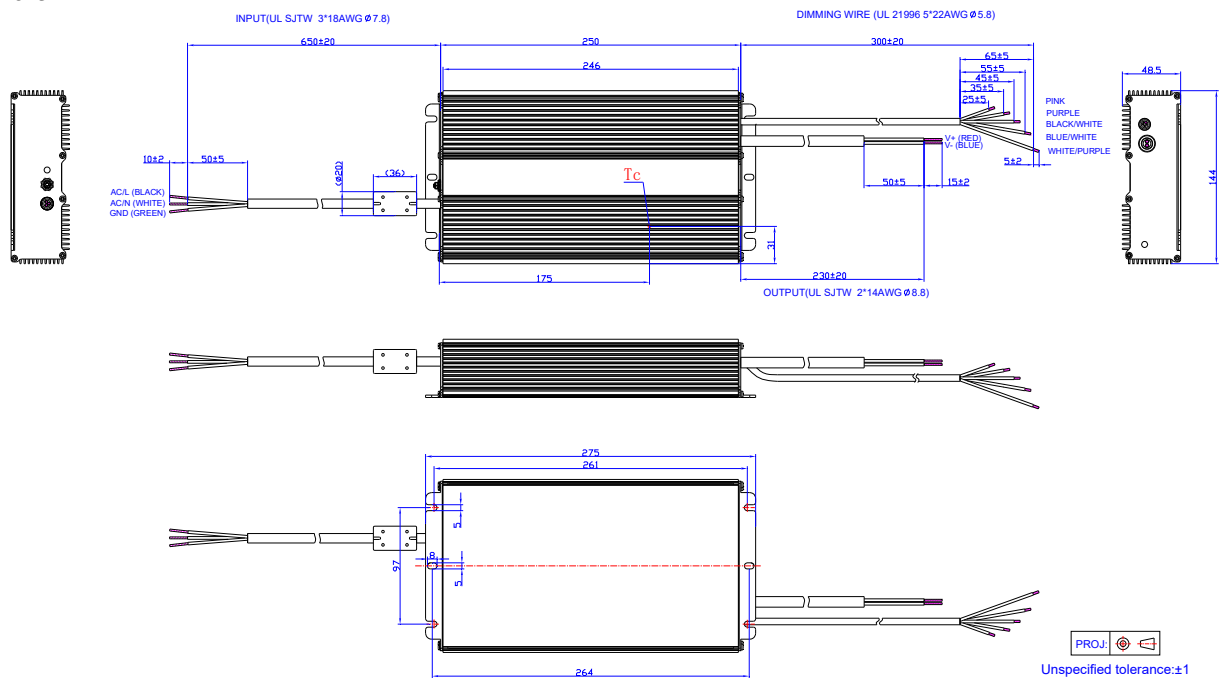

RoHS Compliance

Our products comply with reference to RoHS Directive (EU) 2015/863 amending 2011/65/EU, calling for the elimination of lead and other hazardous substances from electronic products.

Revision History

Change Date	Rev.	Description of Change		
		Item	From	To
2017-05-15	A	Datasheets Release	/	/
2017-10-25	B	Features	7 Years Warranty	Added
		Input Specifications	PF/THD	Updated
		General Specifications	Operating Case Temperature for Warranty Tc_w	Updated
2018-01-17	C	Output Specifications	No Load Output Voltage	Updated
		General Specifications	Lifetime	Updated
		Operating Case Temperature for Warranty Tc_w	+70°C	+75°C
		Lifetime vs. Case Temperature	/	Updated
2019-01-18	D	Features	DALI/Timer Dimmable (3 Timer Modes)	DALI/3 Timer-Modes Dimmable
		Models	EUD-600S140BT	Added
		I-V Operating Area	EUD-600S140BT	Added
		Output Specifications - Output Current Setting(lose) Range	EUD-600S140BT	Added
		Output Specifications - Output Current Setting Range with Constant Power	EUD-600S140BT	Added
		Output Specifications - No Load Output Voltage	EUD-600S140BT	Added
		General Specifications - Efficiency at 120 Vac input:	EUD-600S140BT	Added
		General Specifications - Efficiency at 220 Vac input:	EUD-600S140BT	Added
		General Specifications - Efficiency at 277 Vac input:	EUD-600S140BT	Added
		Dimming Specifications - Dimming Output Range	EUD-600S140BT	Added
		Efficiency vs. Load curve	EUD-600S140BT	Added
		Total Harmonic Distortion curve	/	Updated
2022-02-25	E	Product Photograph	/	Updated
		Features	/	Updated
		Programming Connection Diagram	/	Updated
		Mechanical Outline	/	Updated