

Features

- High Efficiency (Up to 91.0%)
- Full Power at Wide Output Current Range (Constant Power)
- 0-5V/0-10V/PWM/Timer Dimmable
- Input Surge Protection: DM 6kV, CM 10kV
- All-Around Protection: OVP, SCP, OTP
- IP67 and UL Dry / Damp / Wet Location
- Class 2 & SELV Output
- TYPE HL, for use in a Class I, Division 2 hazardous (Classified) location
- UL Type TL (Temperature Limited)
- Class P, UL Listed Versions Available (See Note 6)
- 7 Years Warranty



Description

The EUG-075SxxxDT series is a 75W, constant-current, programmable LED driver that operates from 90-305 Vac input with excellent power factor. Created for many lighting applications including low bay, tunnel and street, etc. The high efficiency of these drivers and compact metal case enables them to run cooler, significantly improving reliability and extending product life. To ensure trouble-free operation, protection is provided against input surge, output over voltage, short circuit, and over temperature.

Models

Adjustable Output Current Range	Full-Power Current Range (1)	Default Output Current	Input Voltage Range(2)	Output Voltage Range	Max. Output Power	Typical Efficiency (3)	Typical Power Factor		Model Number (7)
							120Vac	220Vac	
45-700mA	450-700mA	530 mA	90~305 Vac/ 127~300 Vdc	54~167Vdc	75 W	91.0%	0.99	0.96	EUG-075S070DT
70-1050mA	700-1050mA	700 mA	90~305 Vac/ 127~300 Vdc	36~107Vdc	75 W	90.5%	0.99	0.96	EUG-075S105DT ⁽⁴⁾
119-1750mA	1190-1750mA	1400 mA	90~305 Vac/ 127~300 Vdc	22 ~ 63Vdc	75 W	90.0%	0.99	0.96	EUG-075S175DT ⁽⁴⁾
140-1800mA	1400-1800mA	1400 mA	90~305 Vac/ 127~300 Vdc	22 ~ 54Vdc	75 W	90.0%	0.99	0.96	EUG-075S180DT ⁽⁵⁾
192-2800mA	1920-2800mA	2100 mA	90~305 Vac/ 127~300 Vdc	14 ~ 39Vdc	75 W	89.0%	0.99	0.96	EUG-075S280DT ⁽⁵⁾

- Notes:** (1) Output current range with constant power at 75W
 (2) Certified input voltage range: UL, FCC 100-277Vac or 127-300Vdc; otherwise 100-240Vac or 127-250Vdc (except KS)
 (3) Measured at 100% load and 220Vac input (see below "General Specifications" for details).
 (4) SELV Output.
 (5) Class 2 & SELV Output.
 (6) Standard part UL Type TL. For UL Listed Class P models add suffix -00C0.
 (7) All the models are certificated to CB and KCC, except EUG-075S180DT.

I-V Operating Area

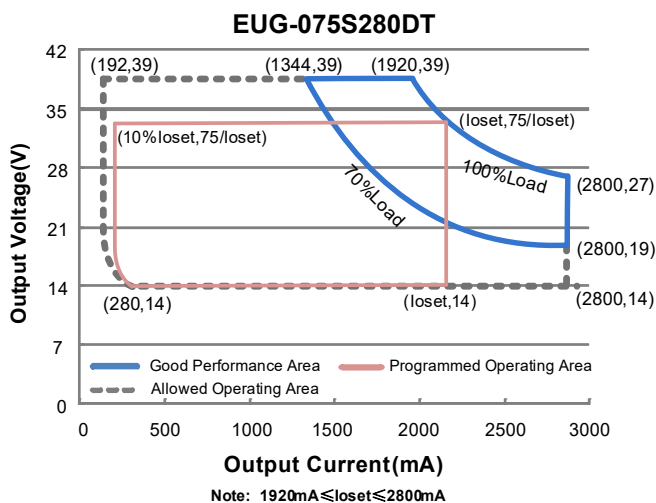
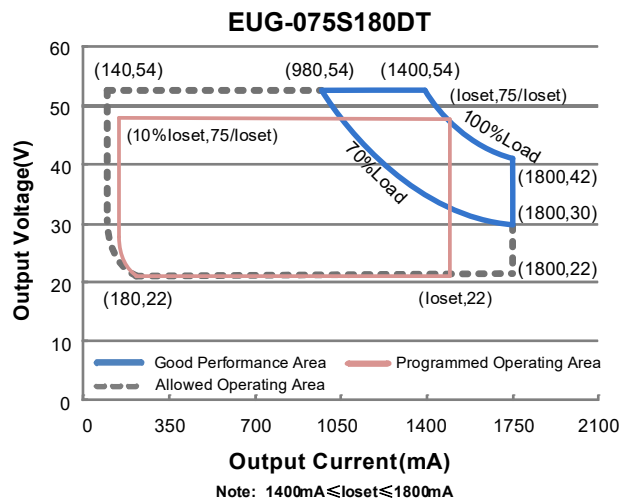
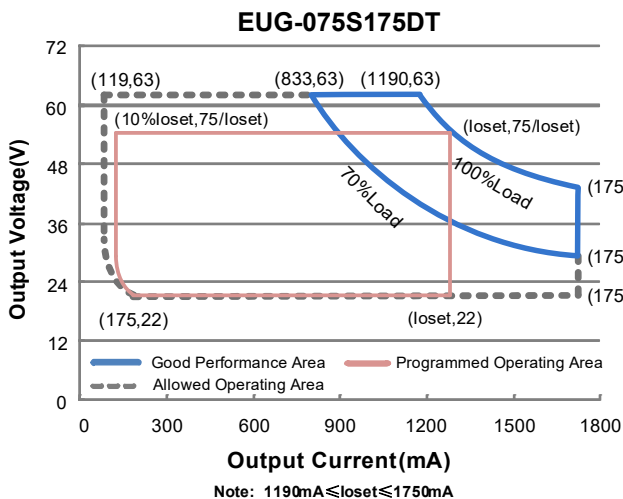
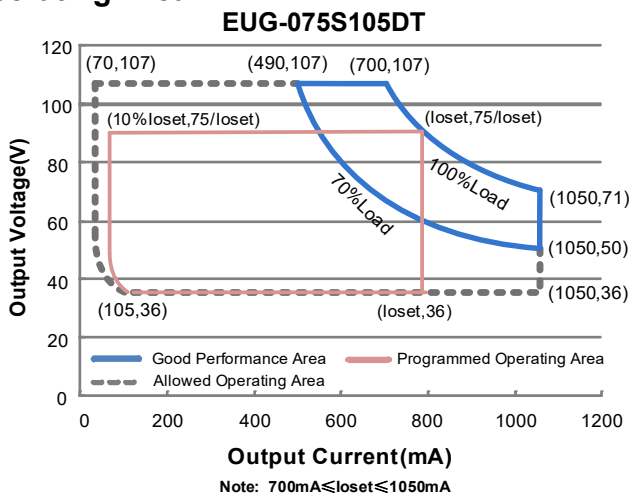
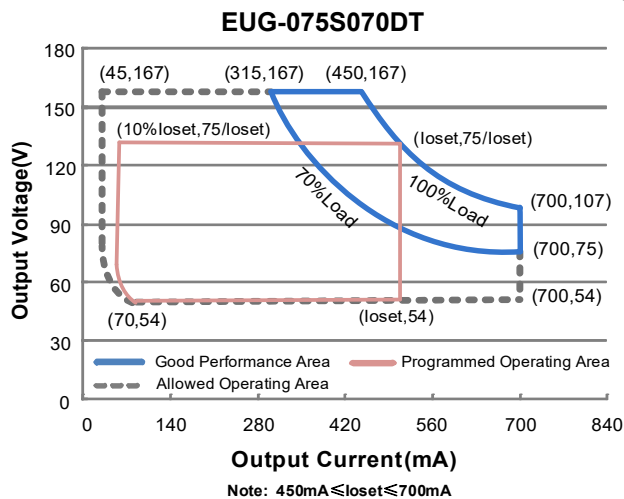

Input Specifications

Parameter	Min.	Typ.	Max.	Notes
Input AC Voltage	90 Vac	-	305 Vac	
Input DC Voltage	127 Vdc	-	300 Vdc	
Input Frequency	47 Hz	-	63 Hz	
Leakage Current	-	-	0.75 MIU	UL8750; 277Vac/ 60Hz, grounding effectively
	-	-	0.70 mA	IEC60598-1; 240Vac/ 60Hz, grounding effectively
Input AC Current	-	-	1.05 A	Measured at 100% load and 100 Vac input.
	-	-	0.48 A	Measured at 100% load and 220 Vac input.
Inrush Current(I ² t)	-	-	1.3 A ² s	At 220Vac input, 25°C cold start, duration=456 μs, 10%I _{pk} -10%I _{pk} . See Inrush Current Waveform for the details.
PF	0.9	-	-	At 100-277Vac, 50-60Hz, 70%-100% Load (52.5-75W)
THD	-	-	20%	
THD	-	-	10%	At 220-240Vac, 50-60Hz, 75%-100% Load (56.25-75W)

Output Specifications

Parameter	Min.	Typ.	Max.	Notes
Output Current Tolerance	-5%loset	-	5%loset	At 100% load condition
Output Current Setting(loset) Range				
EUG-075S070DT	45 mA	-	700 mA	
EUG-075S105DT	70 mA	-	1050 mA	
EUG-075S175DT	119 mA	-	1750 mA	
EUG-075S180DT	140 mA	-	1800 mA	
EUG-075S280DT	192 mA	-	2800 mA	
Output Current Setting Range with Constant Power				
EUG-075S070DT	450 mA	-	700 mA	
EUG-075S105DT	700 mA	-	1050 mA	
EUG-075S175DT	1190 mA	-	1750 mA	
EUG-075S180DT	1400 mA	-	1800 mA	
EUG-075S280DT	1920 mA	-	2800 mA	
Total Output Current Ripple (pk-pk)	-	5%lomax	10%lomax	At 100% load condition. 20 MHz BW
Output Current Ripple at < 200 Hz (pk-pk)	-	1%lomax	-	At 100% load condition. Only this component of ripple is associated with visible flicker.
Startup Overshoot Current	-	-	10%lomax	At 100% load condition
No Load Output Voltage				
EUG-075S070DT	-	-	180 V	
EUG-075S105DT	-	-	118 V	
EUG-075S175DT	-	-	67 V	
EUG-075S180DT	-	-	59 V	
EUG-075S280DT	-	-	48 V	

Output Specifications (Continued)

Parameter	Min.	Typ.	Max.	Notes
Line Regulation	-	-	±0.5%	Measured at 100% load
Load Regulation	-	-	±1.5%	
Turn-on Delay Time	-	-	1.0 s	Measured at 120Vac input, 70%-100% Load
	-	-	0.5 s	Measured at 220Vac input, 70%-100% Load
Temperature Coefficient of I _o set	-	0.03%/°C	-	Case temperature = 0°C ~T _c max
12V Auxiliary Output Voltage	10.8 V	12 V	13.2 V	
12V Auxiliary Output Source Current	0 mA	-	20 mA	Return terminal is "Dim"

General Specifications

Parameter	Min.	Typ.	Max.	Notes
Efficiency at 120 Vac input: EUG-075S070DT				Measured at 100% load and steady-state temperature in 25°C ambient; (Efficiency will be about 2.0% lower if measured immediately after startup.)
I _o = 450mA	86.0%	88.0%	-	
I _o = 700mA	87.0%	89.0%	-	
EUG-075S105DT				
I _o = 700mA	86.0%	88.0%	-	
I _o =1050mA	86.5%	88.5%	-	
EUG-075S175DT				
I _o =1190mA	85.5%	87.5%	-	
I _o =1750mA	86.0%	88.0%	-	
EUG-075S180DT				
I _o =1400mA	85.5%	87.5%	-	
I _o =1800mA	86.0%	88.0%	-	
EUG-075S280DT				
I _o =1920mA	85.5%	87.5%	-	
I _o =2800mA	84.5%	86.5%	-	
Efficiency at 220 Vac input: EUG-075S070DT				Measured at 100% load and steady-state temperature in 25°C ambient; (Efficiency will be about 2.0% lower if measured immediately after startup.)
I _o = 450mA	88.5%	90.5%	-	
I _o = 700mA	89.0%	91.0%	-	
EUG-075S105DT				
I _o = 700mA	88.0%	90.0%	-	
I _o =1050mA	88.5%	90.5%	-	
EUG-075S175DT				
I _o =1190mA	87.5%	89.5%	-	
I _o =1750mA	88.0%	90.0%	-	
EUG-075S180DT				
I _o =1400mA	87.5%	89.5%	-	
I _o =1800mA	88.0%	90.0%	-	
EUG-075S280DT				
I _o =1920mA	87.5%	89.5%	-	
I _o =2800mA	87.0%	89.0%	-	

General Specifications (Continued)

Parameter	Min.	Typ.	Max.	Notes
Efficiency at 277 Vac input: EUG-075S070DT Io= 450mA Io= 700mA EUG-075S105DT Io= 700mA Io=1050mA EUG-075S175DT Io=1190mA Io=1750mA EUG-075S180DT Io=1400mA Io=1800mA EUG-075S280DT Io=1920mA Io=2800mA	89.0% 89.0% 88.0% 88.5% 88.0% 88.5% 88.0% 88.5% 88.0% 87.0%	91.0% 91.0% 90.0% 90.5% 90.0% 90.5% 90.0% 90.5% 90.0% 89.0%	- - - - - - - - - -	Measured at 100% load and steady-state temperature in 25°C ambient; (Efficiency will be about 2.0% lower if measured immediately after startup.)
MTBF	-	328,000 Hours	-	Measured at 220Vac input, 80%Load and 25°C ambient temperature (MIL-HDBK-217F)
Lifetime	-	99,000 Hours	-	Measured at 220Vac input, 80%Load and 70°C case temperature; See lifetime vs. Tc curve for the details
Operating Case Temperature for Safety Tc_s	-40°C	-	+90°C	
Operating Case Temperature for Warranty Tc_w	-40°C	-	+75°C	Case temperature for 7 years warranty. Please see <i>Inventronics Warranty Statement</i> for complete details. Humidity: 10%RH to 95%RH
Operating Case Temperature for Type TL Tc_TL	-40°C	-	+67°C	Only UL Type TL models
Storage Temperature	-40°C	-	+85°C	Humidity: 5%RH to 95%RH
Dimensions Inches (L × W × H) Millimeters (L × W × H)		5.91 × 2.66 × 1.44 150 × 67.5 × 36.5		With mounting ear 6.97 × 2.66 × 1.44 177 × 67.5 × 36.5
Net Weight	-	790 g	-	

Dimming Specifications

Parameter	Min.	Typ.	Max.	Notes
Absolute Maximum Voltage on the Vdim (+) Pin	-20 V	-	20 V	
Source Current on Vdim (+)Pin	200 uA	300 uA	450 uA	Vdim(+) = 0 V

Dimming Specifications (Continued)

Parameter		Min.	Typ.	Max.	Notes
Dimming Output Range	EUG-075S070DT EUG-075S105DT EUG-075S175DT EUG-075S180DT EUG-075S280DT	10%I _{load}	-	I _{load}	450 mA ≤ I _{load} ≤ 700 mA 700 mA ≤ I _{load} ≤ 1050 mA 1190 mA ≤ I _{load} ≤ 1750 mA 1400 mA ≤ I _{load} ≤ 1800 mA 1920 mA ≤ I _{load} ≤ 2800 mA
	EUG-075S070DT EUG-075S105DT EUG-075S175DT EUG-075S180DT EUG-075S280DT	45 mA 70 mA 119 mA 140 mA 192 mA	-	I _{load}	45 mA ≤ I _{load} < 450 mA 70 mA ≤ I _{load} < 700 mA 119 mA ≤ I _{load} < 1190 mA 140 mA ≤ I _{load} < 1400 mA 192 mA ≤ I _{load} < 1920 mA
Recommended Dimming Range for 0-5V		0 V	-	5 V	Dimming mode set to 0-5V in PC interface.
Recommended Dimming Range for 0-10V		0 V	-	10 V	Default 0-10V dimming mode with positive logic.
PWM_in High Level		3 V	-	10 V	Dimming mode set to PWM in PC interface.
PWM_in Low Level		-0.3 V	-	0.6 V	
PWM_in Frequency Range		200 Hz	-	2 KHz	
PWM_in Duty Cycle		1%	-	99%	

Safety & EMC Compliance

Safety Category	Standard
UL/CUL	UL8750, UL1310, CAN/CSA-C22.2 No. 250.13, CAN/CSA-C22.2 No. 223-M91
CE	EN 61347-1, EN 61347-2-13
CB	IEC 61347-1, IEC 61347-2-13
KS	KS C 7655
NOM	NOM-058-SCFI
EMI Standards	Notes
EN 55015/KN 15 ⁽¹⁾	Conducted emission Test & Radiated emission Test
EN 61000-3-2	Harmonic current emissions
EN 61000-3-3	Voltage fluctuations & flicker
FCC Part 15 ⁽¹⁾	ANSI C63.4 Class B
	This device complies with Part 15 of the FCC Rules. Operation is subject to the following two conditions: [1] this device may not cause harmful interference, and [2] this device must accept any interference received, including interference that may cause undesired Operation.
EMS Standards	Notes
EN 61000-4-2	Electrostatic Discharge (ESD): 8 kV air discharge, 4 kV contact discharge
EN 61000-4-3	Radio-Frequency Electromagnetic Field Susceptibility Test-RS

Safety & EMC Compliance (Continued)

EMS Standards	Notes
EN 61000-4-4	Electrical Fast Transient / Burst-EFT
EN 61000-4-5	Surge Immunity Test: AC Power Line: Differential Mode 6 kV, Common Mode 10 kV ⁽²⁾
EN 61000-4-6	Conducted Radio Frequency Disturbances Test-CS
EN 61000-4-8	Power Frequency Magnetic Field Test
EN 61000-4-11	Voltage Dips
EN 61547	Electromagnetic Immunity Requirements Applies To Lighting Equipment

Note: (1) This LED driver meets the EMI specifications above, but EMI performance of a luminaire that contains it depends also on the other devices connected to the driver and on the fixture itself.

(2) To perform electric strength (hi-pot) testing, the “GDT ground disconnect” (nut and metal lock sheet) on the driver end-cap should be removed temporarily to prevent the internal gas discharge tube from conducting (as allowed by IEC 60598-1 Clause 10.2). After testing is completed, these items must be reinstalled to restore line-to-earth surge protection and secure the end cap.

Lifetime vs. Case Temperature

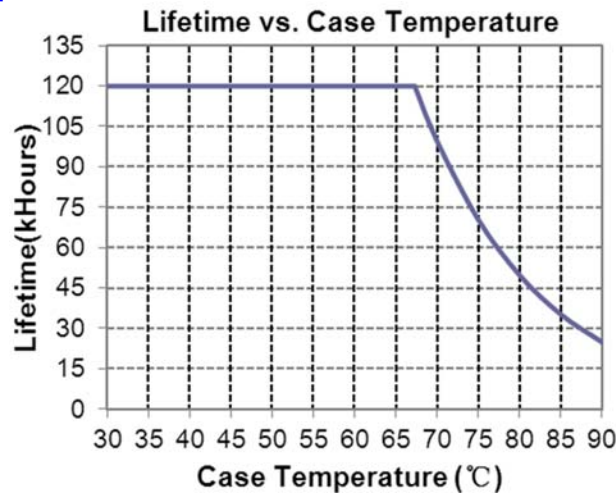

Inrush Current Waveform

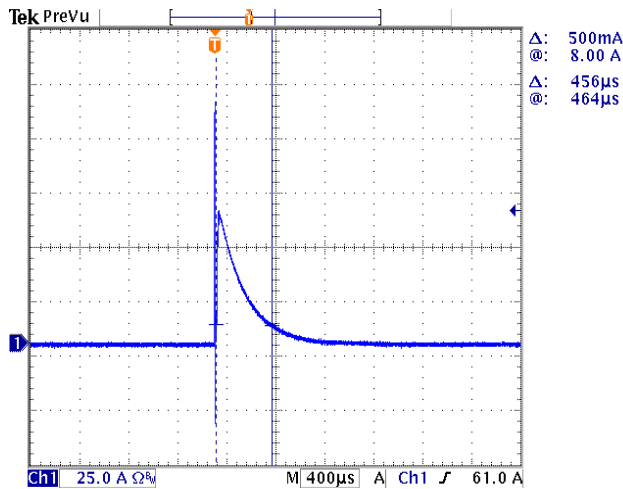

Efficiency vs. Load

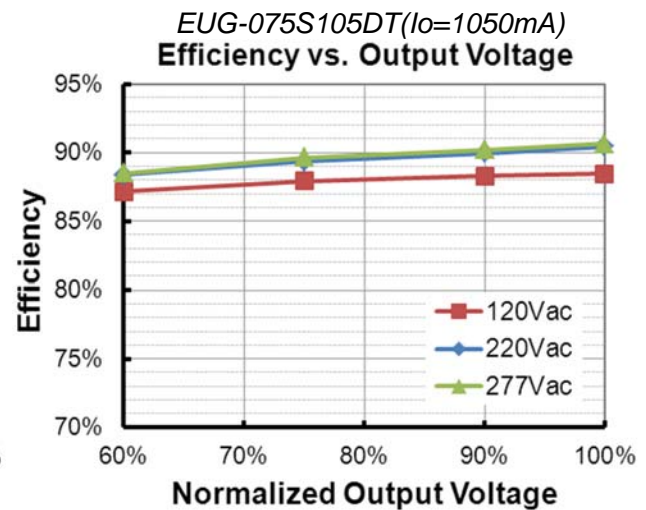
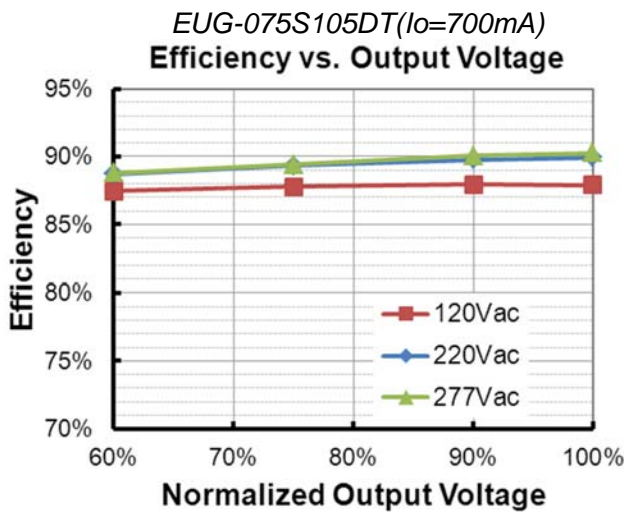
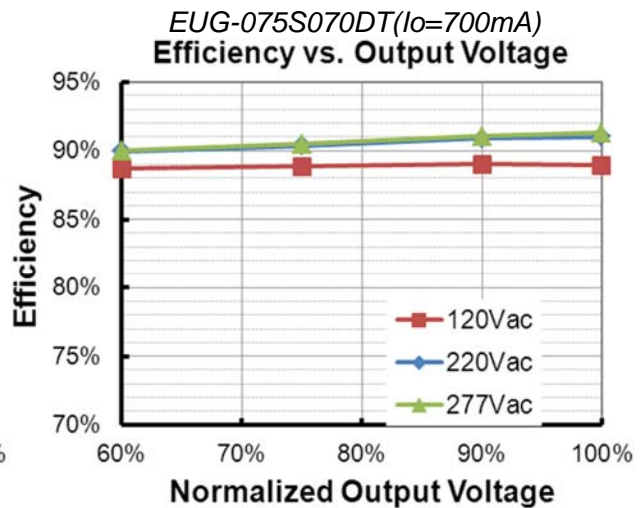
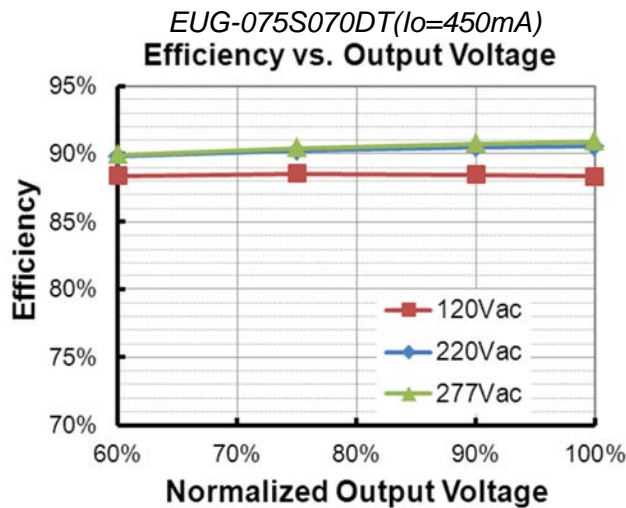

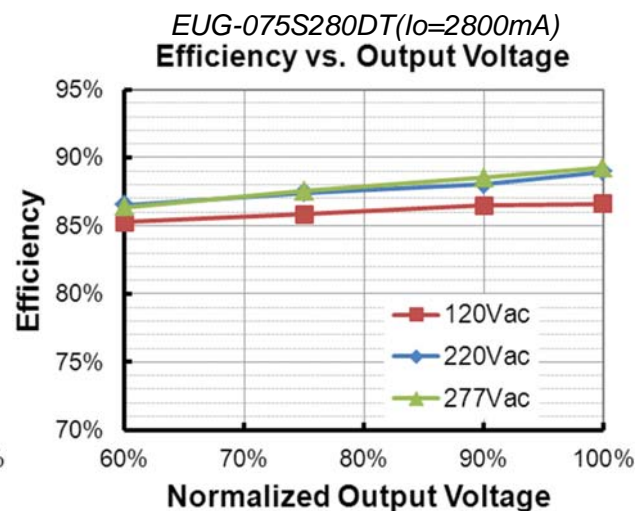
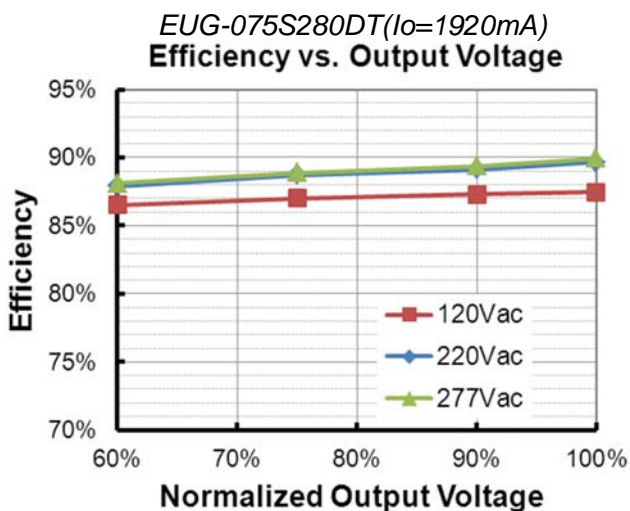
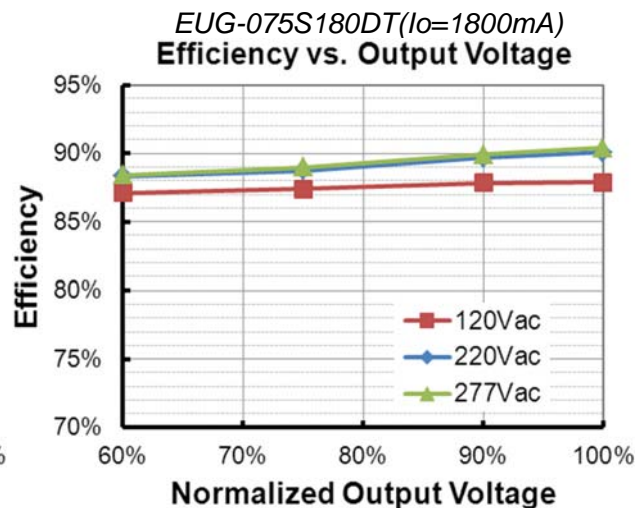
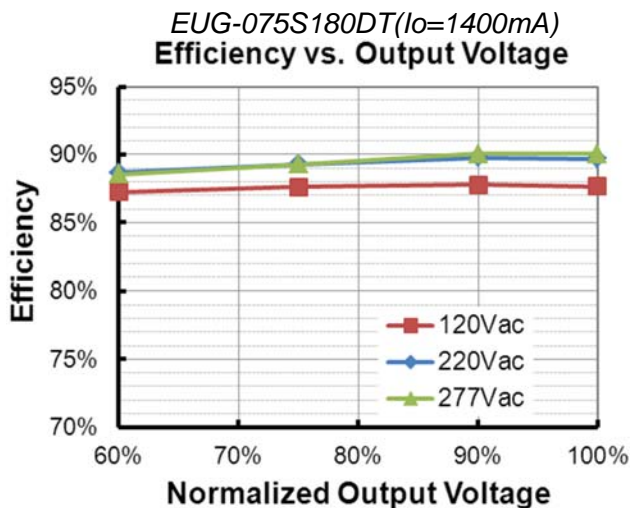
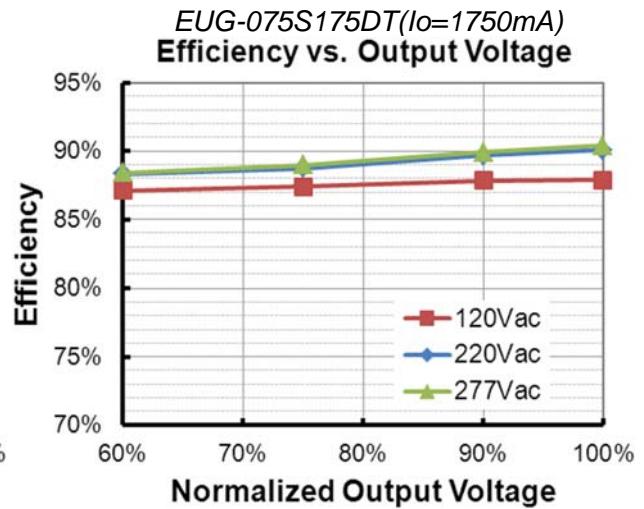
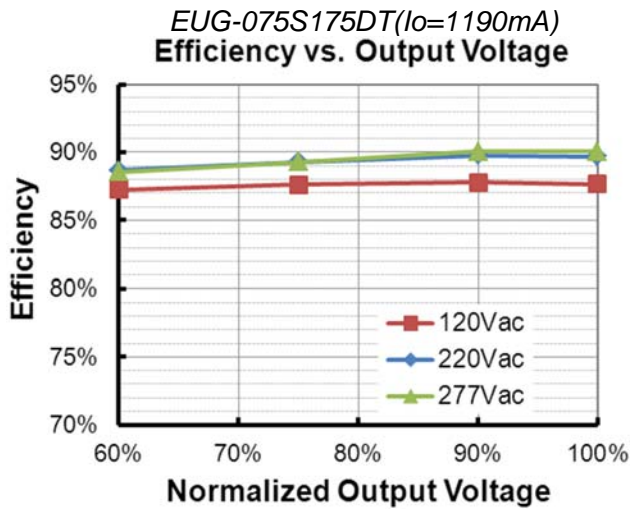

Power Factor

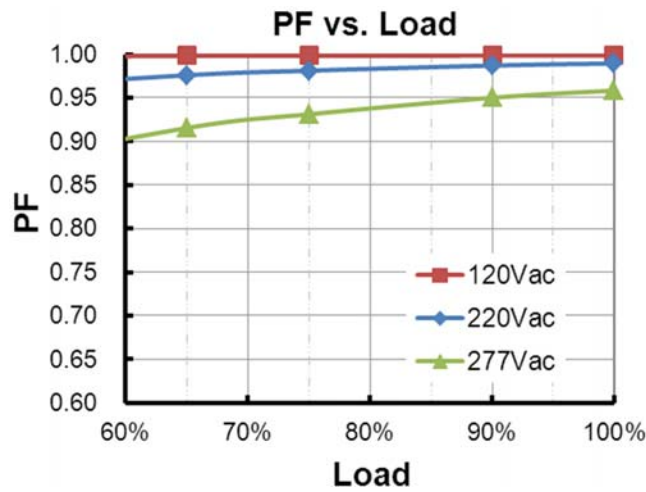

Total Harmonic Distortion

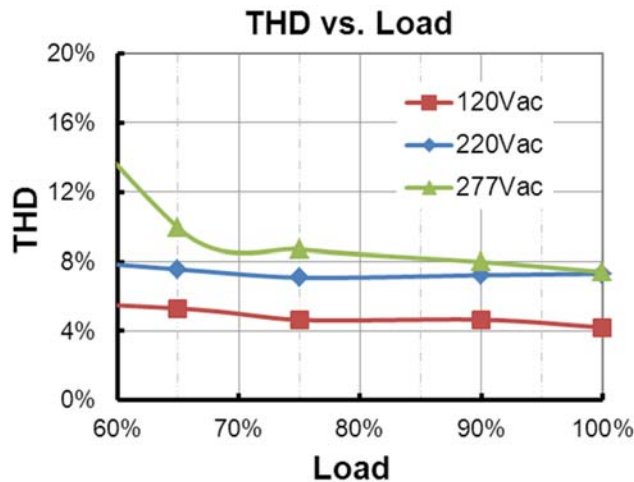

Protection Functions

Parameter	Notes
Over Temperature Protection	Decreases output current, returning to normal after over temperature is removed.
Short Circuit Protection	Auto Recovery. No damage will occur when any output is short circuited. The output shall return to normal when the fault condition is removed.
Over Voltage Protection	Limits output voltage at no load and in case the normal voltage limit fails.

Dimming

● 0-5V Dimming

The recommended implementation of the dimming control is provided below.

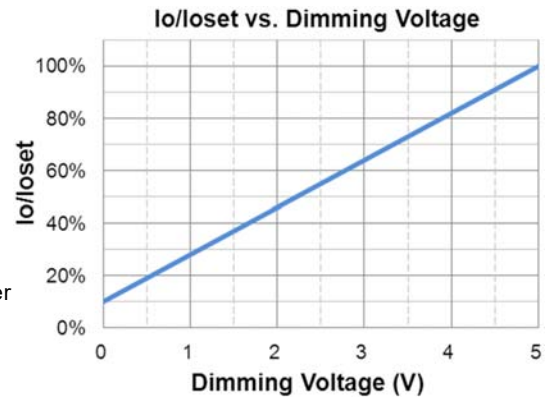
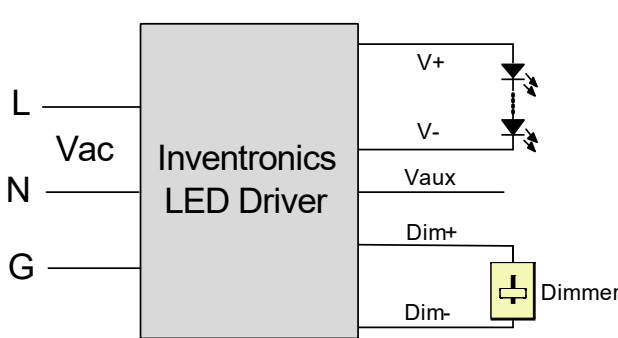

Implementation 1: Positive logic

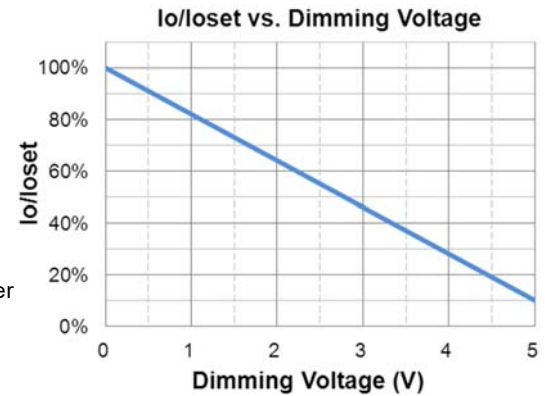
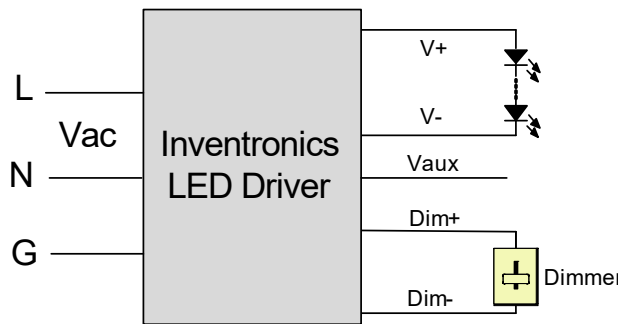

Implementation 2: Negative logic

Notes:

1. Do NOT connect Dim- to the output V- or V+, otherwise the driver will not work properly.
2. The dimmer can also be replaced by an active 0-5V voltage source signal or passive components like zener.
3. When 0-5V negative logic dimming mode and Dim+ is open, the driver will output maximum current.

● **0-10V Dimming**

The recommended implementation of the dimming control is provided below.

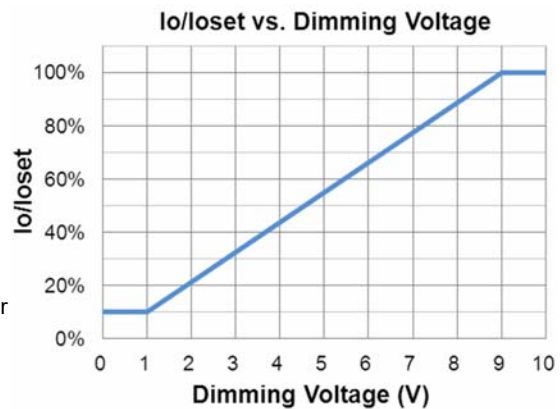
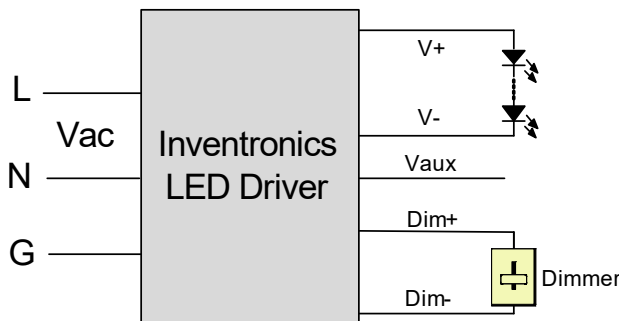

Implementation 3: Positive logic

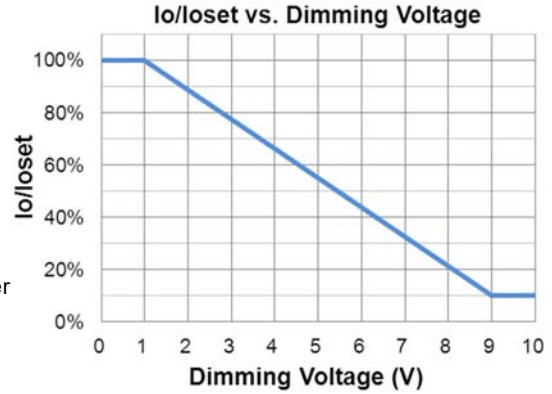
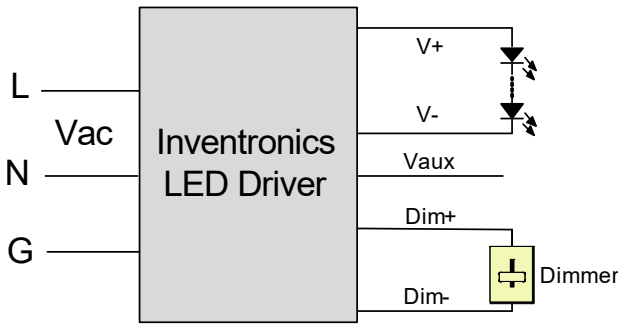

Implementation 4: Negative logic

Notes:

1. Do NOT connect Dim- to the output V- or V+, otherwise the driver will not work properly.
2. The dimmer can also be replaced by an active 0-10V voltage source signal or passive components like zener.
3. When 0-10V negative logic dimming mode and Dim+ is open, the driver will output minimum current.

● **PWM Dimming**

The recommended implementation of the dimming control is provided below.

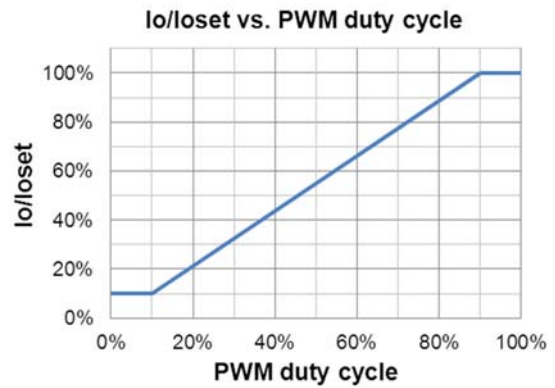
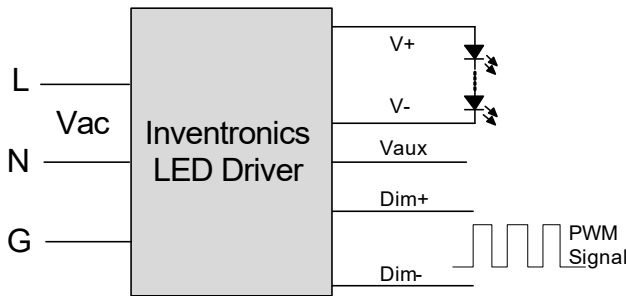

Implementation 5: Positive logic

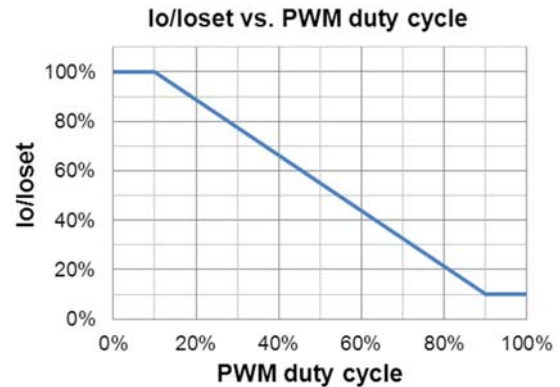
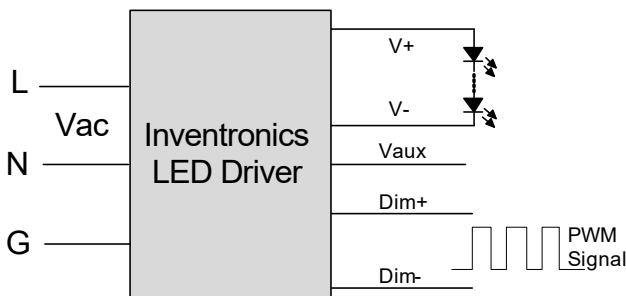

Implementation 6: Negative logic

Notes:

1. Do NOT connect Dim- to the output V- or V+, otherwise the driver will not work properly.
2. When PWM negative logic dimming mode and Dim+ is open, the driver will output minimum current.

● Time Dimming

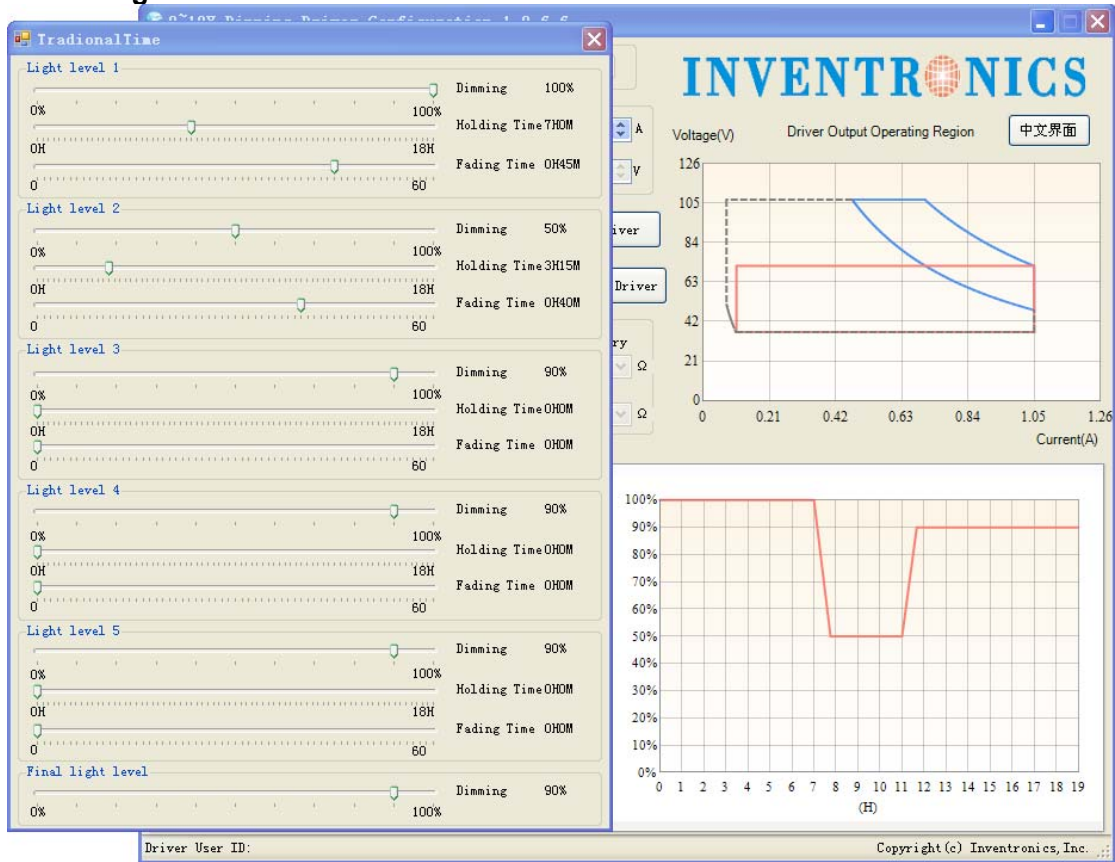

Set the timing curve by pulling the sliders.

Programming Connection Diagram

EUG-075SxxxDT

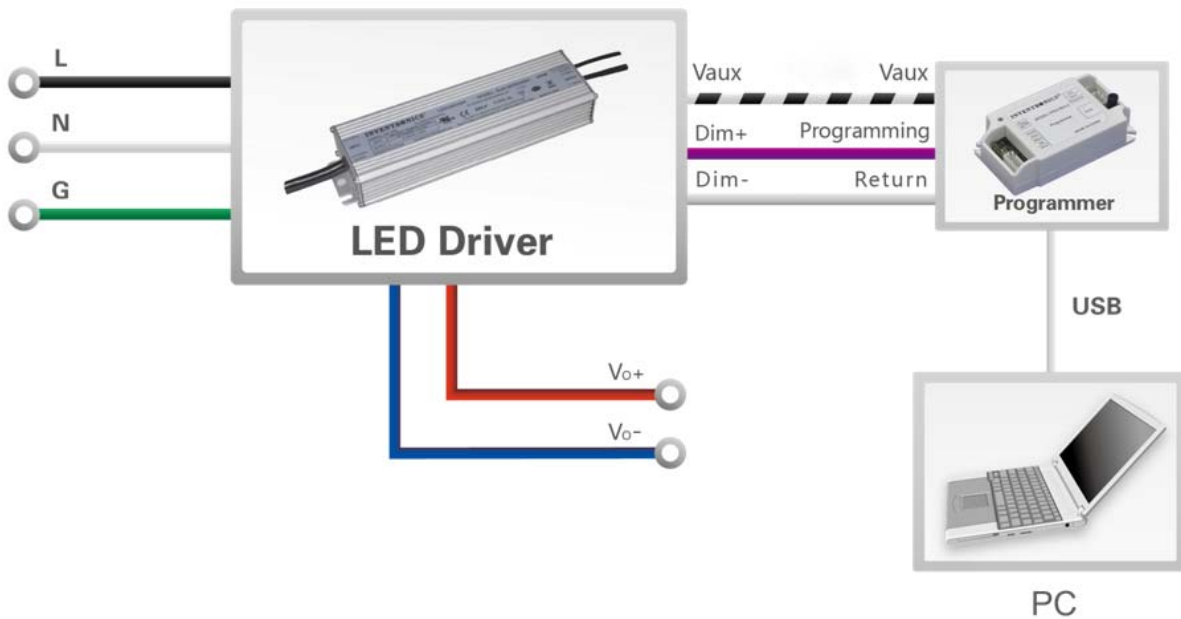

EUG-075SxxxDT-00C0

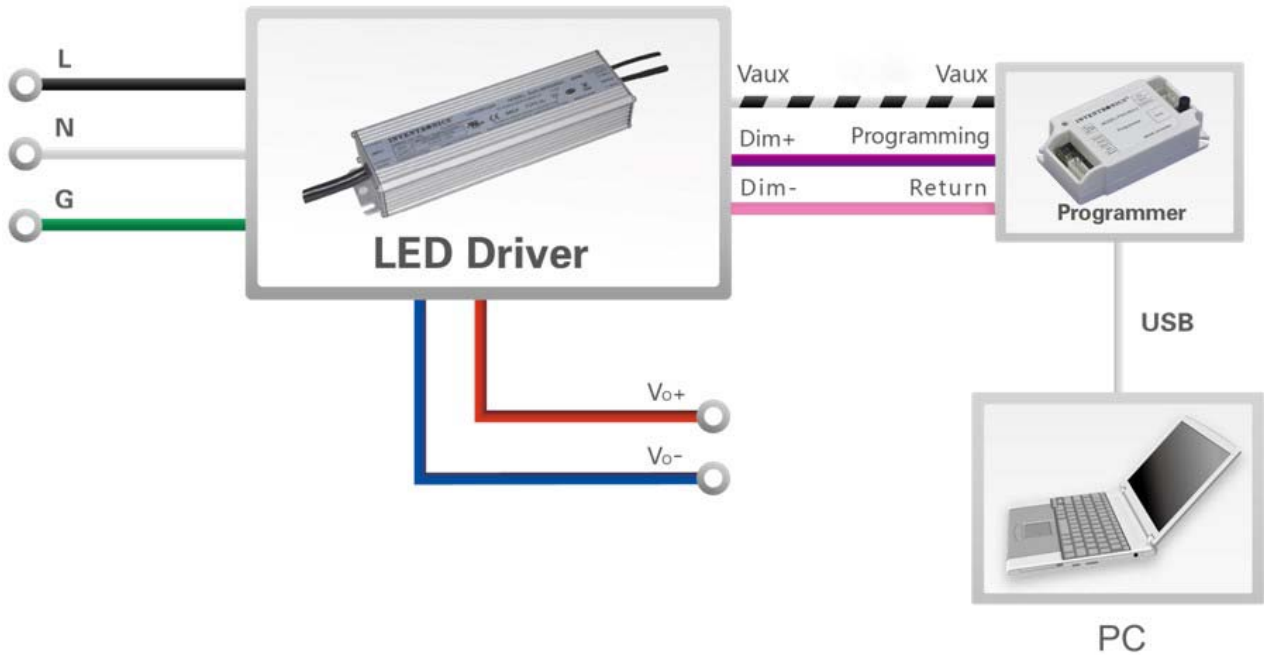

Note: The driver does not need to be powered on during the programming process.

- Please refer to [PRG-MUL2](#) (Programmer) datasheet for details.

Mechanical Outline

EUG-075SxxxDT

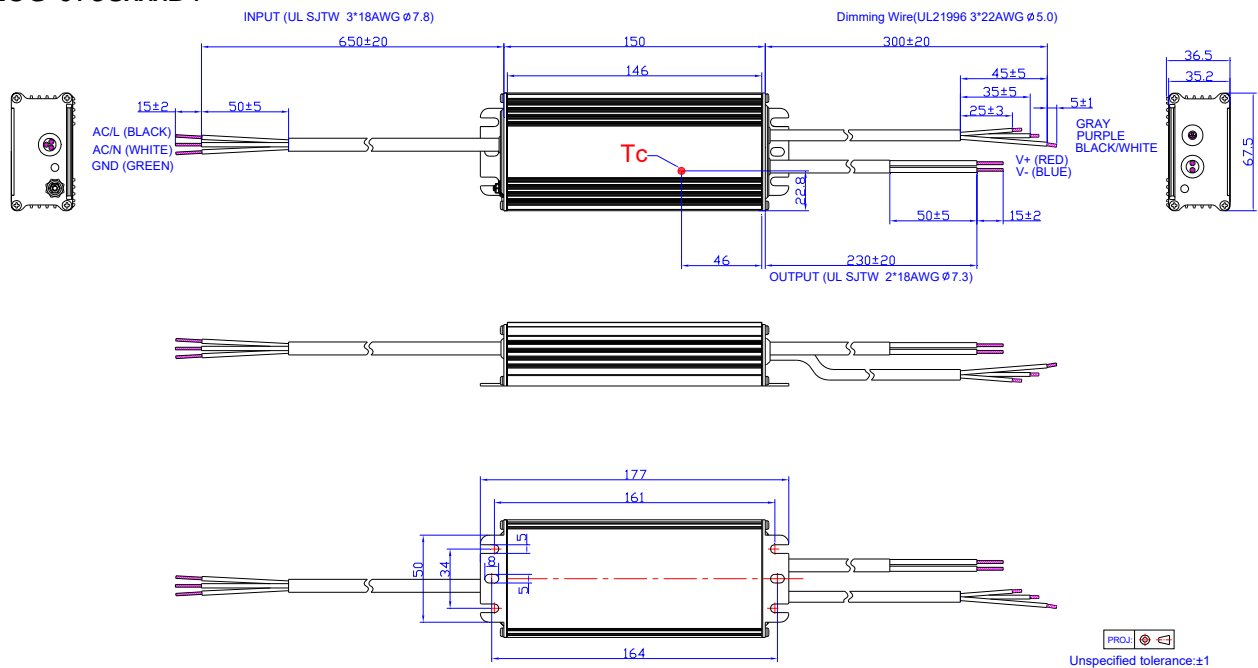

EUG-075SxxxDT-00C0

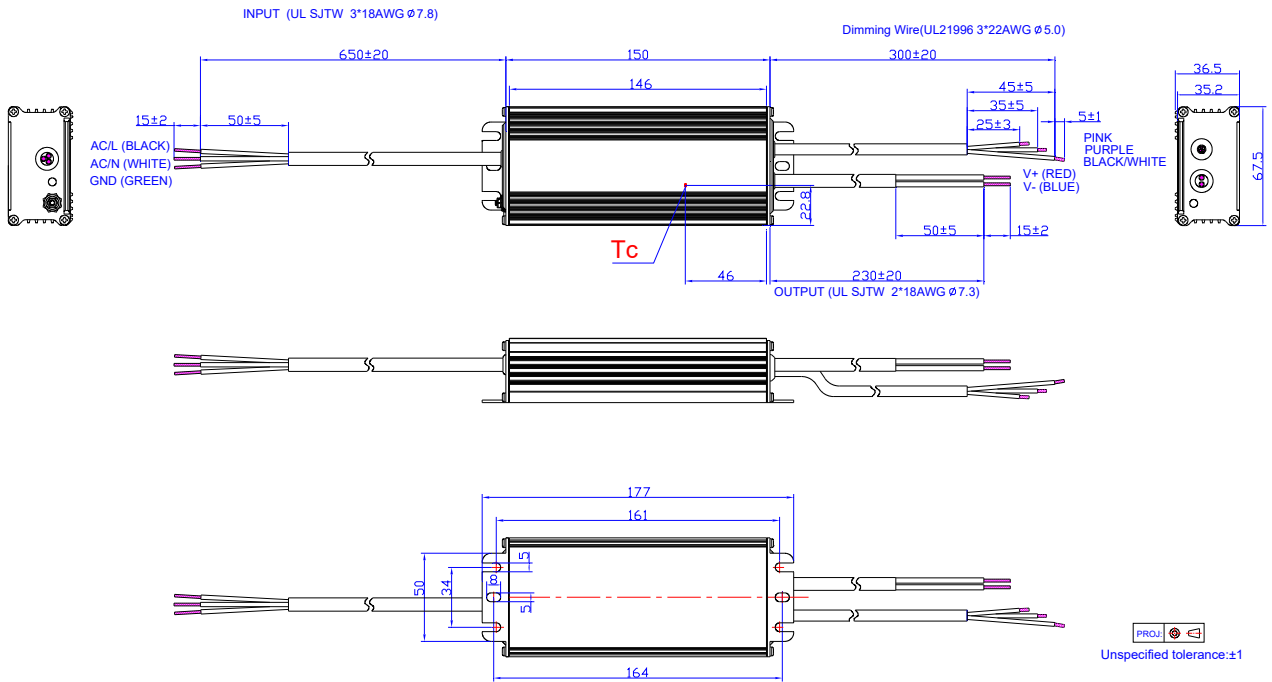

RoHS Compliance

Our products comply with reference to RoHS Directive (EU) 2015/863 amending 2011/65/EU, calling for the elimination of lead and other hazardous substances from electronic products.

Revision History

Change Date	Rev.	Description of Change		
		Item	From	To
2015-12-28	A	Datasheets Release	/	/
2016-04-12	B	Features	/	Updated
		General Specifications	Operating Case Temperature for Type TL Tc_TL	Added
		General Specifications	Net Weight	Updated
		General Specifications	With mounting ear	Added
		Safety & EMC Compliance	/	Updated
		Mechanical Outline	/	Updated
2017-03-28	C	EUG-075S180DT	/	Added
		I-V Operation Area	EUG-075S180DT	Added
		Output Specifications	Output Current Setting(losct) Range	Updated
		Output Specifications	Output Current Setting Range with Constant Power	Updated
		Output Specifications	No Load Output Voltage	Updated
		General Specifications	Efficiency at 120 Vac input	Updated
		General Specifications	Efficiency at 220 Vac input	Updated
		General Specifications	Efficiency at 277 Vac input	Updated
		Dimming Specifications	Dimming Output Range	Updated
		Safety & EMC Compliance	/	Updated
		Efficiency vs. Load	EUG-075S180DT	Added
		Mechanical Outline	/	Updated
2017-07-26	D	Input Specifications	PF/THD	Updated
2017-10-25	E	Features	Class P, UL Listed Versions Available (See Note 6)	Added
		Features	7 Years Warranty	Added
		Models	(6) Standard part UL Type TL. For UL Listed Class P models add suffix -00C0.	Added
		Operating Case Temperature for Warranty Tc_w	/	Updated
		Operating Case Temperature for Type TL Tc_TL	Only UL Type TL models	Added

Revision History (Continued)

Change Date	Rev.	Description of Change		
		Item	From	To
2022-02-25	F	Features	/	Updated
		Description	/	Updated
		CB/KCC/NOM logo	/	Added
		Models	Notes(7)	Added
		General Specifications	Humidity	Updated
		Safety &EMC Compliance	/	Updated
		Dimming	/	Updated
		Programming Connection Diagram	EUG-075SxxxDT-00C0	Added
		Mechanical Outline	EUG-075SxxxDT-00C0	Added
		RoHS Compliance	/	Updated