

## Features

- High Efficiency (Up to 91.0%)
- Full Power at Wide Output Current Range (Constant Power)
- 0-5V/0-10V/PWM/Timer Dimmable
- Input Surge Protection: DM 6kV, CM 10kV
- All-Around Protection: OVP, SCP, OTP
- IP67
- SELV Output
- 7 Years Warranty



## Description

The EUG-075SxxxDV series is a 75W, constant-current, programmable LED driver that operates from 90-305 Vac input with excellent power factor. It is created for many lighting applications including low bay, tunnel and street, etc. The high efficiency of these drivers and compact metal case enables them to run cooler, significantly improving reliability and extending product life. To ensure trouble-free operation, protection is provided against input surge, output over voltage, short circuit, and over temperature.

## Models

Adjustable Output Current Range	Full-Power Current Range (1)	Default Output Current	Input Voltage Range(2)	Output Voltage Range	Max. Output Power	Typical Efficiency (3)	Power Factor		Model Number
							120Vac	220Vac	
45-700mA	450-700mA	530 mA	90~305 Vac/ 127~250 Vdc	54~167Vdc	75 W	91.0%	0.99	0.96	EUG-075S070DV
70-1050mA	700-1050mA	700 mA	90~305 Vac/ 127~250 Vdc	36~107Vdc	75 W	90.5%	0.99	0.96	EUG-075S105DV <sup>(4)</sup>
119-1750mA	1190-1750mA	1400 mA	90~305 Vac/ 127~250 Vdc	22 ~ 63Vdc	75 W	90.0%	0.99	0.96	EUG-075S175DV <sup>(4)</sup>
192-2800mA	1920-2800mA	2100 mA	90~305 Vac/ 127~250 Vdc	14 ~ 39Vdc	75 W	89.0%	0.99	0.96	EUG-075S280DV <sup>(4)</sup>

- Notes:** (1) Output current range with constant power at 75W.  
 (2) Certified input Voltage range 100-240Vac or 127-250Vdc (except CCC, PSE, KS and BIS).  
 (3) Measured at 100% load and 220Vac input (see below "General Specifications" for details).  
 (4) SELV output.  
 (5) For BIS models add suffix -3000.

## I-V Operating Area

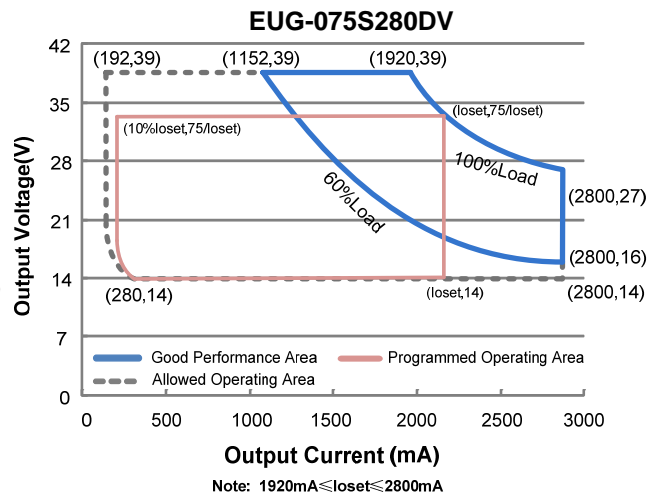
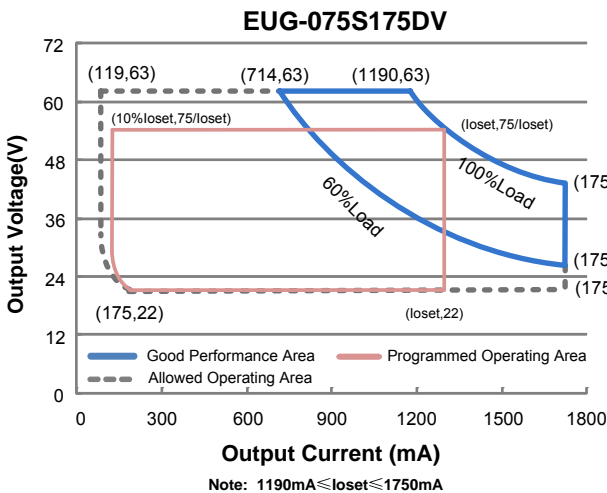
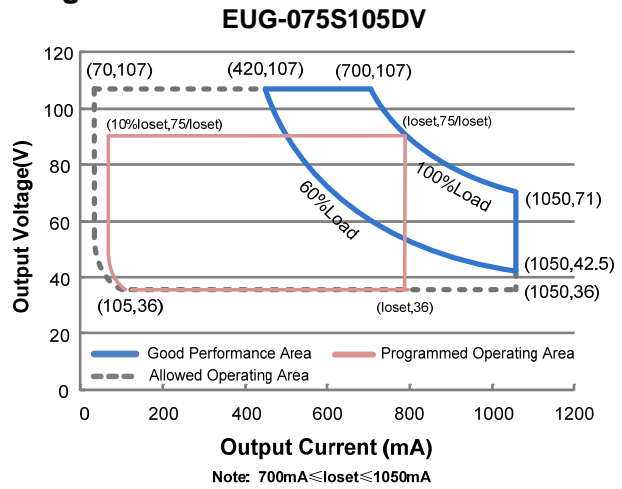
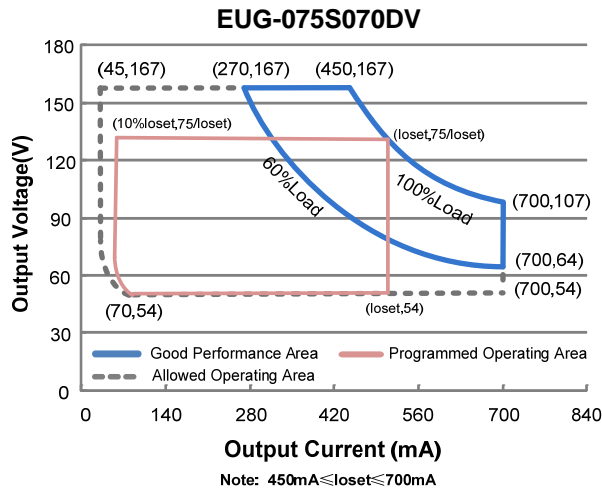

## Input Specifications

Parameter	Min.	Typ.	Max.	Notes
Input Voltage	90 Vac	-	305 Vac	127~250 Vdc
Input Frequency	47 Hz	-	63 Hz	
Leakage Current	-	-	0.70 mA	IEC60598-1; 240Vac/ 60Hz, grounding effectively
Input AC Current	-	-	1.05 A	Measured at 100% load and 100 Vac input.
	-	-	0.48 A	Measured at 100%load and 220 Vac input.
Inrush Current(I <sup>2</sup> t)	-	-	1.3 A <sup>2</sup> s	At 220Vac input, 25°C cold start, duration=456 μs, 10%Ipk-10%Ipk. See Inrush Current Waveform for the details.
PF	0.9	-	-	At 100-240Vac, 50-60Hz, 60%-100% Load (45-75W)
THD	-	-	20%	
THD	-	-	10%	At 220-240Vac, 50-60Hz, 75%-100% Load (56.25-75W)

## Output Specifications

Parameter	Min.	Typ.	Max.	Notes
Output Current Tolerance	-5%loset	-	5%loset	At 100%load condition
Output Current Setting(loset) Range				
EUG-075S070DV	45 mA	-	700 mA	
EUG-075S105DV	70 mA	-	1050 mA	
EUG-075S175DV	119 mA	-	1750 mA	
EUG-075S280DV	192 mA	-	2800 mA	
Output Current Setting Range with Constant Power				
EUG-075S070DV	450 mA	-	700 mA	
EUG-075S105DV	700 mA	-	1050 mA	
EUG-075S175DV	1190 mA	-	1750 mA	
EUG-075S280DV	1920 mA	-	2800 mA	
Total Output Current Ripple (pk-pk)	-	5%lomax	10%lomax	At 100%load condition. 20 MHz BW
Output Current Ripple at < 200 Hz (pk-pk)	-	1%lomax	-	At 100%load condition. Only this component of ripple is associated with visible flicker.
Startup Overshoot Current	-	-	10%lomax	At 100%load condition
No Load Output Voltage				
EUG-075S070DV	-	-	180 V	
EUG-075S105DV	-	-	118 V	
EUG-075S175DV	-	-	67 V	
EUG-075S280DV	-	-	48 V	
Line Regulation	-	-	±0.5%	Measured at 100%load
Load Regulation	-	-	±1.5%	
Turn-on Delay Time	-	-	1.0 s	Measured at 120Vac input, 60%-100% Load
	-	-	0.5 s	Measured at 220Vac input, 60%-100% Load
Temperature Coefficient of loset	-	0.03%/°C	-	Case temperature = 0°C ~Tc max
12V Auxiliary Output Voltage	10.8 V	12 V	13.2 V	
12V Auxiliary Output Source Current	0 mA	-	20 mA	Return terminal is "Dim"

## General Specifications

Parameter	Min.	Typ.	Max.	Notes
Efficiency at 120 Vac input:				
EUG-075S070DV				
Io= 450mA	86.0%	88.0%	-	Measured at 100%load and steady-state temperature in 25°C ambient; (Efficiency will be about 2.0% lower if measured immediately after startup.)
Io= 700mA	87.0%	89.0%	-	
EUG-075S105DV				
Io= 700mA	86.0%	88.0%	-	
Io=1050mA	86.5%	88.5%	-	
EUG-075S175DV				
Io=1190mA	85.5%	87.5%	-	
Io=1750mA	86.0%	88.0%	-	
EUG-075S280DV				
Io=1920mA	85.5%	87.5%	-	
Io=2800mA	84.5%	86.5%	-	

## General Specifications (Continued)

Parameter	Min.	Typ.	Max.	Notes
Efficiency at 220 Vac input: EUG-075S070DV I <sub>o</sub> = 450mA I <sub>o</sub> = 700mA EUG-075S105DV I <sub>o</sub> = 700mA I <sub>o</sub> =1050mA EUG-075S175DV I <sub>o</sub> =1190mA I <sub>o</sub> =1750mA EUG-075S280DV I <sub>o</sub> =1920mA I <sub>o</sub> =2800mA	88.5% 89.0% 88.0% 88.5% 87.5% 88.0% 87.5% 87.0%	90.5% 91.0% 90.0% 90.5% 89.5% 90.0% 89.5% 89.0%	- - - - - - - -	Measured at 100%load and steady-state temperature in 25°C ambient; (Efficiency will be about 2.0% lower if measured immediately after startup.)
Efficiency at 277 Vac input: EUG-075S070DV I <sub>o</sub> = 450mA I <sub>o</sub> = 700mA EUG-075S105DV I <sub>o</sub> = 700mA I <sub>o</sub> =1050mA EUG-075S175DV I <sub>o</sub> =1190mA I <sub>o</sub> =1750mA EUG-075S280DV I <sub>o</sub> =1920mA I <sub>o</sub> =2800mA	89.0% 89.0% 88.0% 88.5% 88.0% 88.5% 88.0% 87.0%	91.0% 91.0% 90.0% 90.5% 90.0% 90.5% 90.0% 89.0%	- - - - - - - -	Measured at 100%load and steady-state temperature in 25°C ambient; (Efficiency will be about 2.0% lower if measured immediately after startup.)
MTBF	-	328,000 Hours	-	Measured at 220Vac input, 80%Load and 25°C ambient temperature (MIL-HDBK-217F)
Lifetime	-	99,000 Hours	-	Measured at 220Vac input, 80%Load and 70°C case temperature; See lifetime vs. Tc curve for the details
Operating Case Temperature for Safety Tc <sub>s</sub>	-40°C	-	+90°C	
Operating Case Temperature for Warranty Tc <sub>w</sub>	-40°C	-	+75°C	Case temperature for 7 years warranty. Please see Inventronics Warranty Statement for complete details.
Storage Temperature	-40°C	-	+85°C	Humidity: 5%RH to 100%RH
Dimensions Inches (L × W × H) Millimeters (L × W × H)	5.91 × 2.66 × 1.44 150 × 67.5 × 36.5			With mounting ear 6.97 × 2.66 × 1.44 177 × 67.5 × 36.5
Net Weight	-	790 g	-	

## Dimming Specifications

Parameter	Min.	Typ.	Max.	Notes
Absolute Maximum Voltage on the Vdim (+) Pin	-20 V	-	20 V	
Source Current on Vdim (+)Pin	200 µA	300 µA	450 µA	Vdim(+) = 0 V

## Dimming Specifications (Continued)

Parameter		Min.	Typ.	Max.	Notes
Dimming Output Range	EUG-075S070DV EUG-075S105DV EUG-075S175DV EUG-075S280DV	10%loset	-	loset	450 mA ≤ loset ≤ 700 mA 700 mA ≤ loset ≤ 1050 mA 1190 mA ≤ loset ≤ 1750 mA 1920 mA ≤ loset ≤ 2800 mA
	EUG-075S070DV EUG-075S105DV EUG-075S175DV EUG-075S280DV	45 mA 70 mA 119 mA 192 mA	-	loset	45 mA ≤ loset < 450 mA 70 mA ≤ loset < 700 mA 119 mA ≤ loset < 1190 mA 192 mA ≤ loset < 1920 mA
Recommended Dimming Range for 0-5V		0 V	-	5 V	Dimming mode set to 0-5V in PC interface.
Recommended Dimming Range for 0-10V		0 V	-	10 V	Default 0-10V dimming mode with positive logic.
PWM_in High Level		3 V	-	10 V	Dimming mode set to PWM in PC interface.
PWM_in Low Level		-0.3 V	-	0.6 V	
PWM_in Frequency Range		200 Hz	-	2 KHz	
PWM_in Duty Cycle		1%	-	99%	

## Safety & EMC Compliance

Safety Category	Standard
ENEC & TUV & CE	EN 61347-1, EN 61347-2-13
CB	IEC 61347-1, IEC 61347-2-13
CCC	GB 19510.1, GB 19510.14
PSE	Appendix 8 & Appendix 10
KS	KS C 7655
BIS	IS 15885(Part2/Sec13)
Global Mark	AS/NZS 61347.1, AS/NZS 61347.2.13
EMI Standards	Notes
EN 55015/GB 17743/KN 15 <sup>(1)</sup>	Conducted emission Test & Radiated emission Test
EN 61000-3-2/GB 17625.1	Harmonic current emissions
EN 61000-3-3	Voltage fluctuations & flicker
EMS Standards	Notes
EN 61000-4-2	Electrostatic Discharge (ESD): 8 kV air discharge, 4 kV contact discharge
EN 61000-4-3	Radio-Frequency Electromagnetic Field Susceptibility Test-RS
EN 61000-4-4	Electrical Fast Transient / Burst-EFT
EN 61000-4-5	Surge Immunity Test: AC Power Line: Differential Mode 6 kV, Common Mode 10 kV <sup>(2)</sup>
EN 61000-4-6	Conducted Radio Frequency Disturbances Test-CS

## Safety & EMC Compliance (Continued)

EMS Standards	Notes
EN 61000-4-8	Power Frequency Magnetic Field Test
EN 61000-4-11	Voltage Dips
EN 61547	Electromagnetic Immunity Requirements Applies To Lighting Equipment

- Note:** (1) This LED driver meets the EMI specifications above, but EMI performance of a luminaire that contains it depends also on the other devices connected to the driver and on the fixture itself.
- (2) To perform electric strength (hi-pot) testing, the "GDT ground disconnect" (nut and metal lock sheet) on the driver end-cap should be removed temporarily to prevent the internal gas discharge tube from conducting (as allowed by IEC 60598-1 Clause 10.2). After testing is completed, these items must be reinstalled to restore line-to-earth surge protection and secure the end cap.

## Lifetime vs. Case Temperature

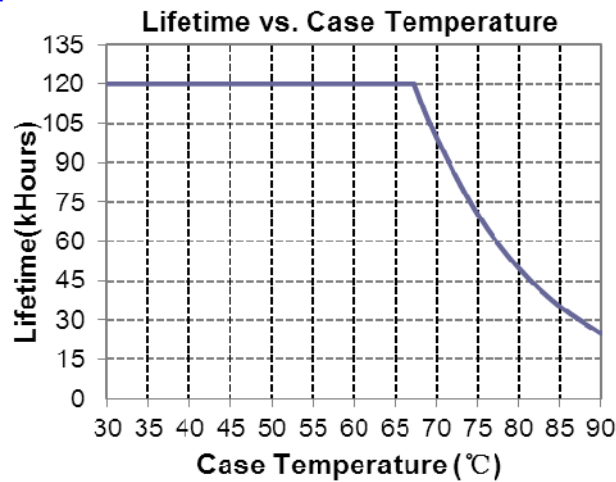

## Inrush Current Waveform

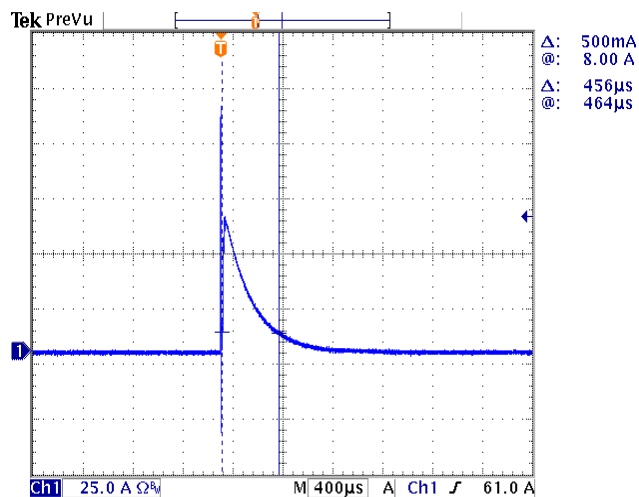

## Efficiency vs. Load

*EUG-075S070DV* ( $I_o=450mA$ )  
Efficiency vs. Output Voltage

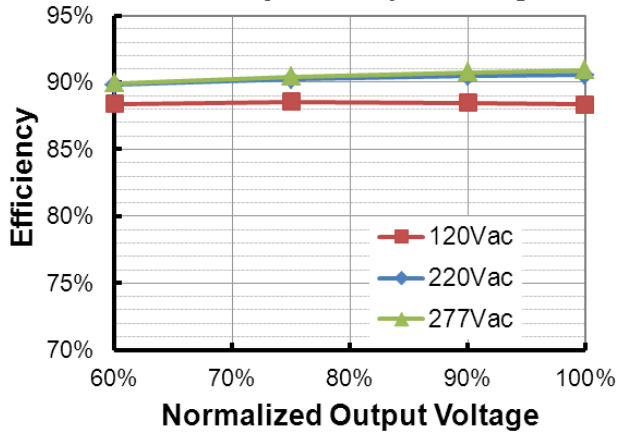

*EUG-075S070DV* ( $I_o=700mA$ )  
Efficiency vs. Output Voltage

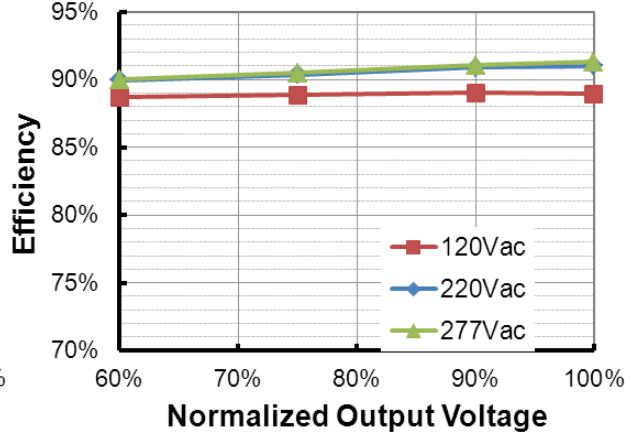

*EUG-075S105DV* ( $I_o=700mA$ )  
Efficiency vs. Output Voltage

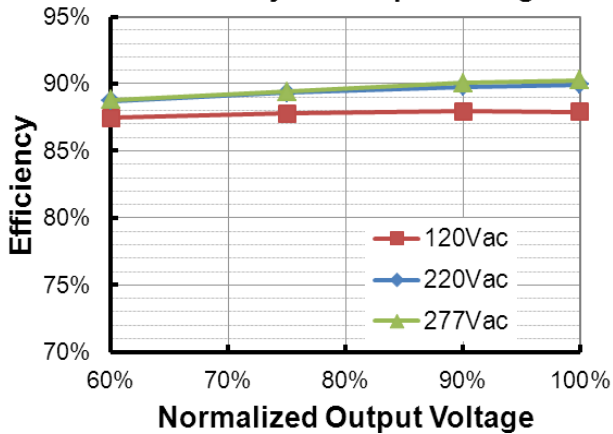

*EUG-075S105DV* ( $I_o=1050mA$ )  
Efficiency vs. Output Voltage

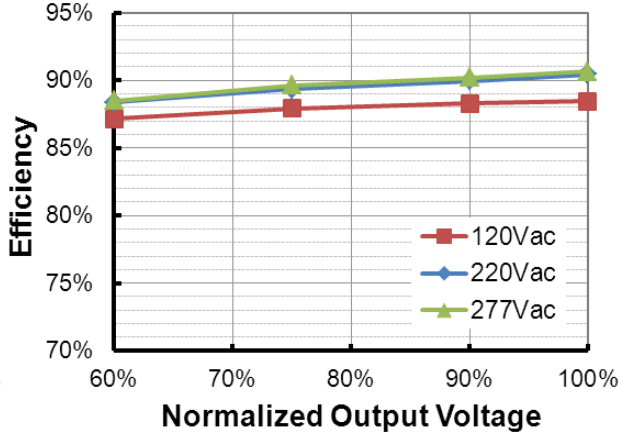

*EUG-075S175DV* ( $I_o=1190mA$ )  
Efficiency vs. Output Voltage

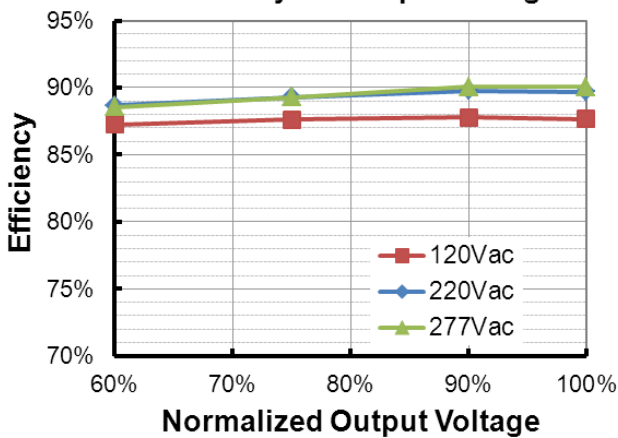

*EUG-075S175DV* ( $I_o=1750mA$ )  
Efficiency vs. Output Voltage

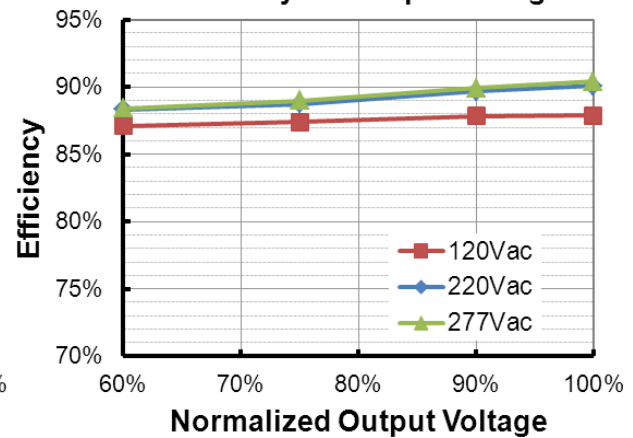

**EUG-075S280DV (Io=1920mA)  
Efficiency vs. Output Voltage**

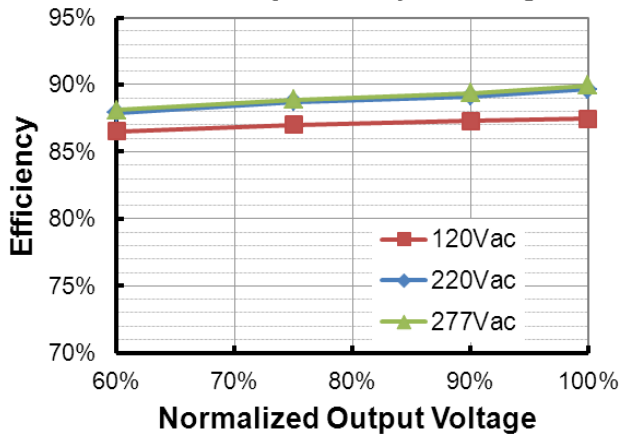

**EUG-075S280DV (Io=2800mA)  
Efficiency vs. Output Voltage**

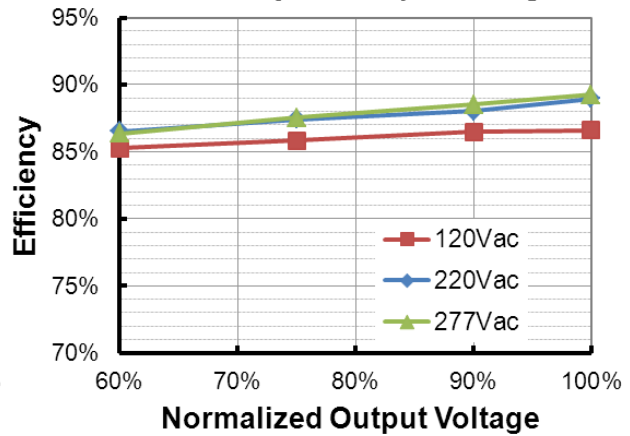

## Power Factor

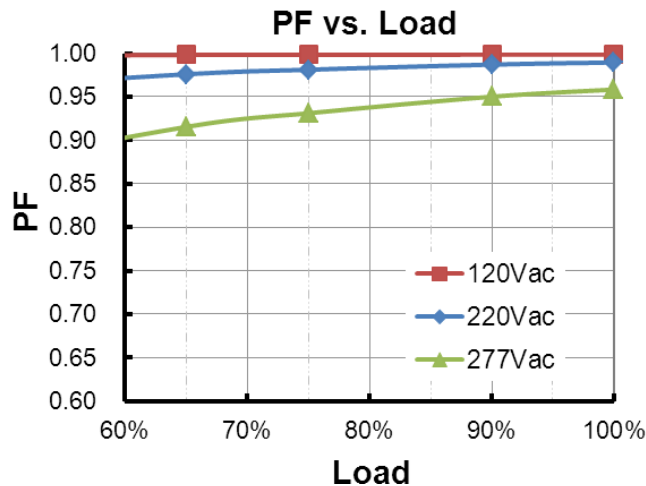

## Total Harmonic Distortion

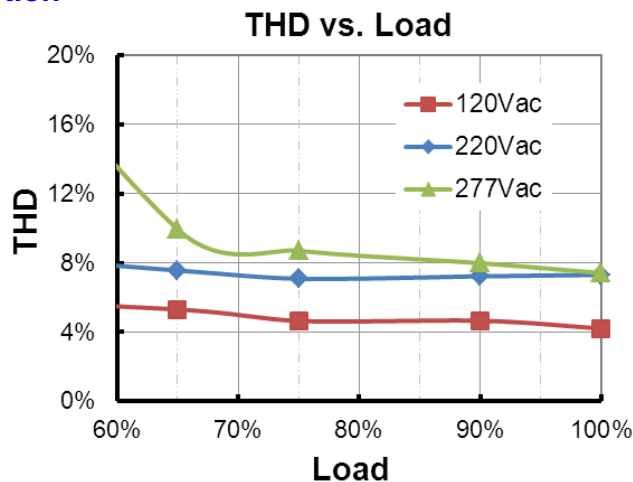



## Protection Functions

Parameter	Notes
Over Temperature Protection	Decreases output current, returning to normal after over temperature is removed.
Short Circuit Protection	Auto Recovery. No damage will occur when any output is short circuited. The output shall return to normal when the fault condition is removed.
Over Voltage Protection	Limits output voltage at no load and in case the normal voltage limit fails.

## Dimming

### ● 0-5V Dimming

The recommended implementation of the dimming control is provided below.

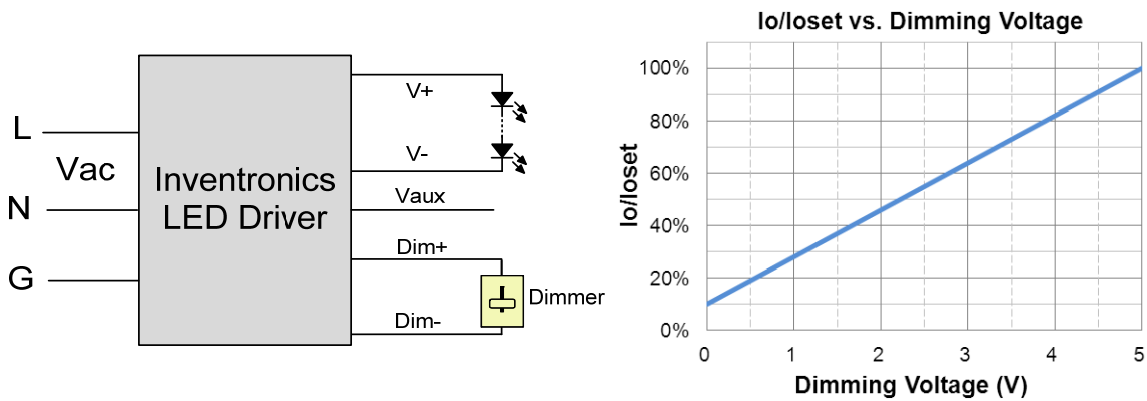

**Implementation 1: Positive logic**

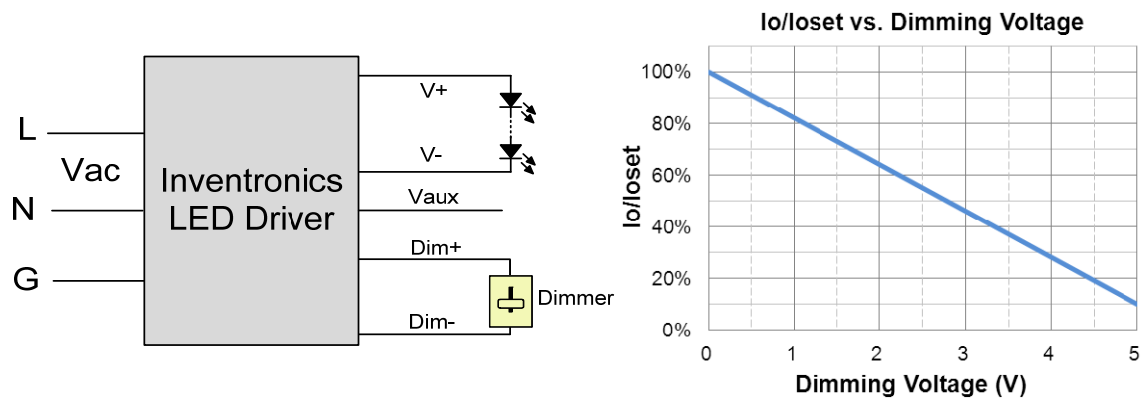

**Implementation 2: Negative logic**

### Notes:

1. The dimmer can also be replaced by an active 0-5V voltage source signal or passive components like resistors and zener.
2. Do NOT connect Dim- to the output V- or V+, otherwise the driver will not work properly.
3. If 0-5V dimming is not used, Dim + should be open.
4. When 0-5V negative logic dimming mode and Dim+ is open, the driver will output maximum current.

## ● 0-10V Dimming

The recommended implementation of the dimming control is provided below.

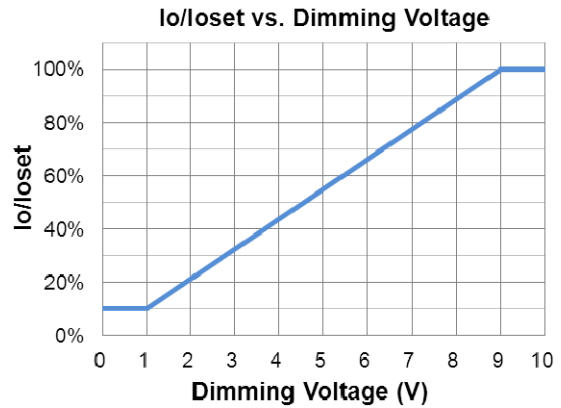
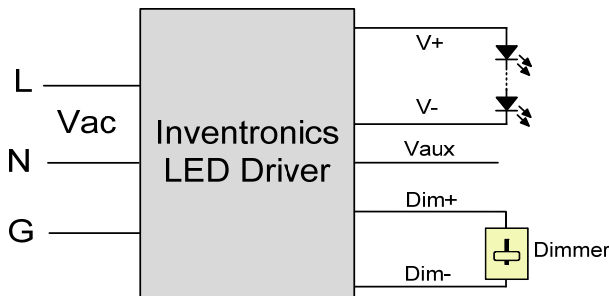

**Implementation 3: Positive logic**

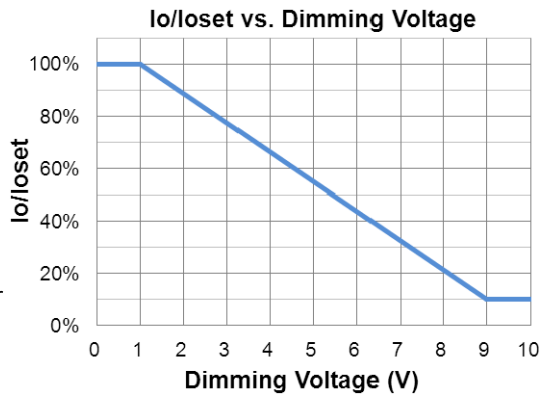
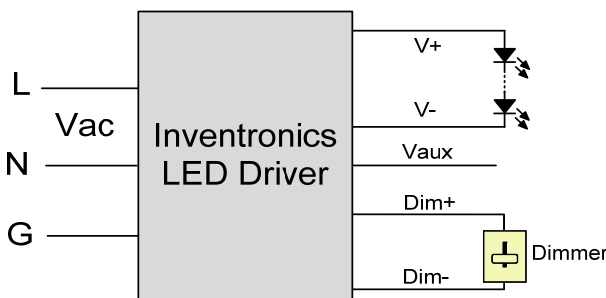

**Implementation 4: Negative logic**

**Notes:**

1. The dimmer can also be replaced by an active 0-10V voltage source signal or passive components like resistors and zener.
2. Do NOT connect Dim- to the output V- or V+, otherwise the driver will not work properly.
3. If 0-10V dimming is not used, Dim + should be open.
4. When 0-10V negative logic dimming mode and Dim+ is open, the driver will output minimum current.

## ● PWM Dimming

The recommended implementation of the dimming control is provided below.

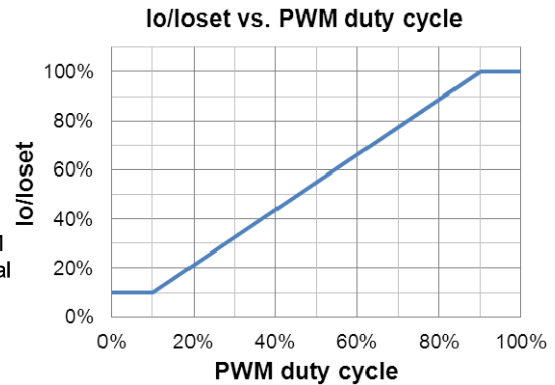
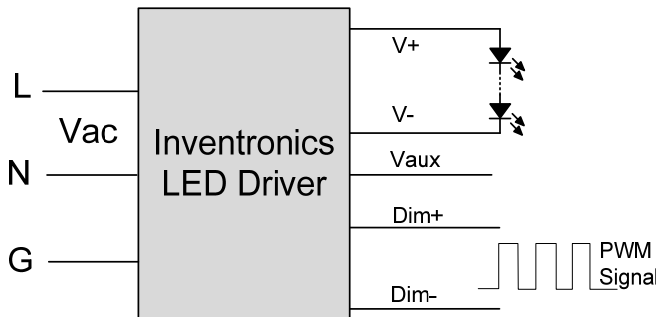

**Implementation 5: Positive logic**

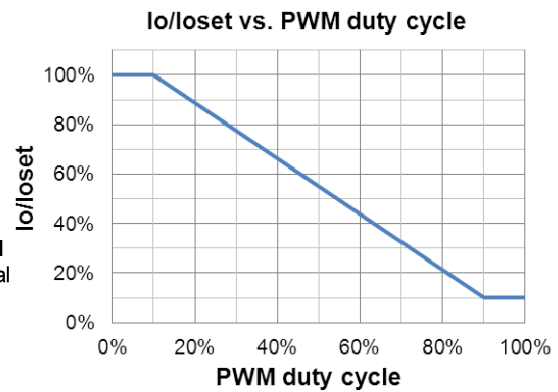
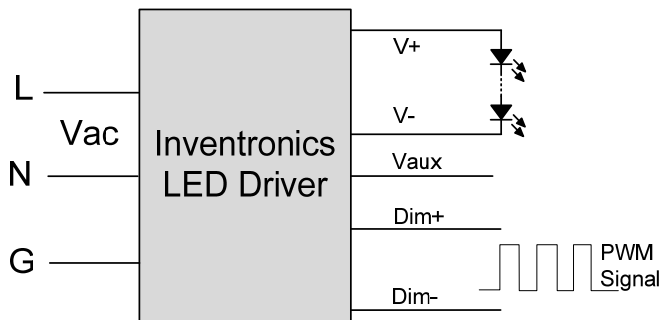

**Implementation 6: Negative logic**

### Notes:

1. Do NOT connect Dim- to the output V- or V+, otherwise the driver will not work properly.
2. If PWM dimming is not used, Dim + should be open.
3. When PWM negative logic dimming mode and Dim+ is open, the driver will output minimum current.

## ● Time Dimming

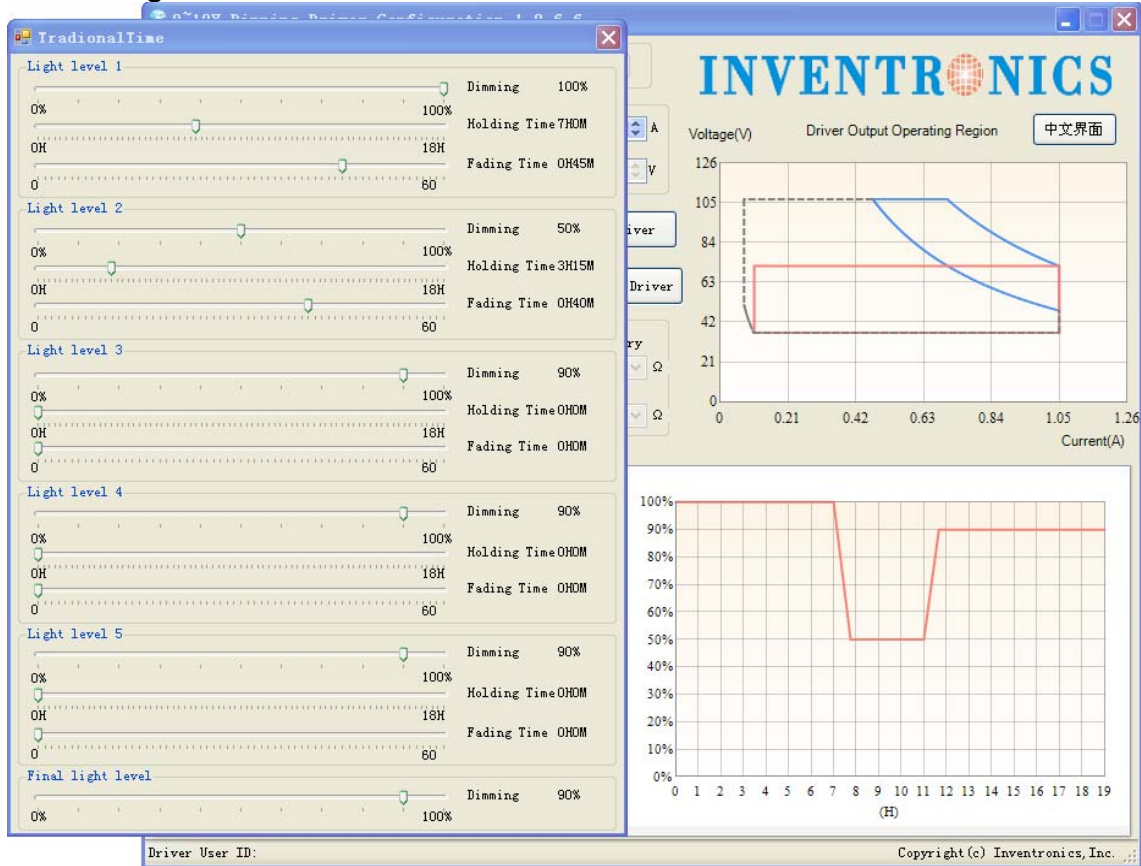

Set the timing curve by pulling the sliders.

## Programming Connection Diagram

EUG-075SxxxDV

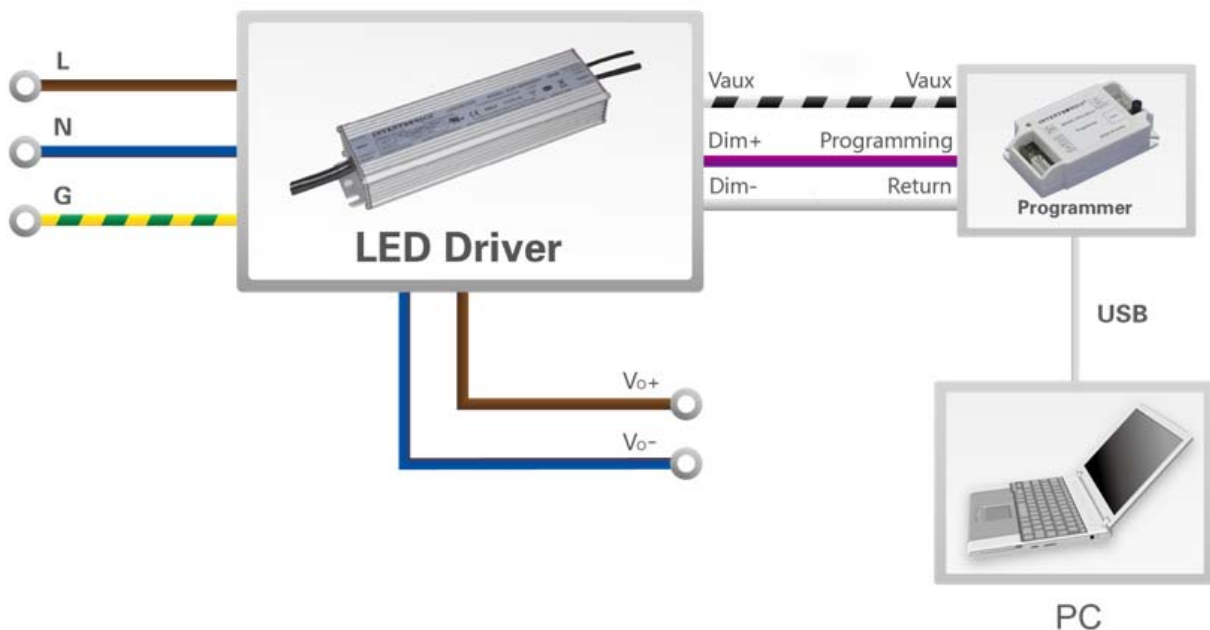

EUG-075SxxxDV-3000

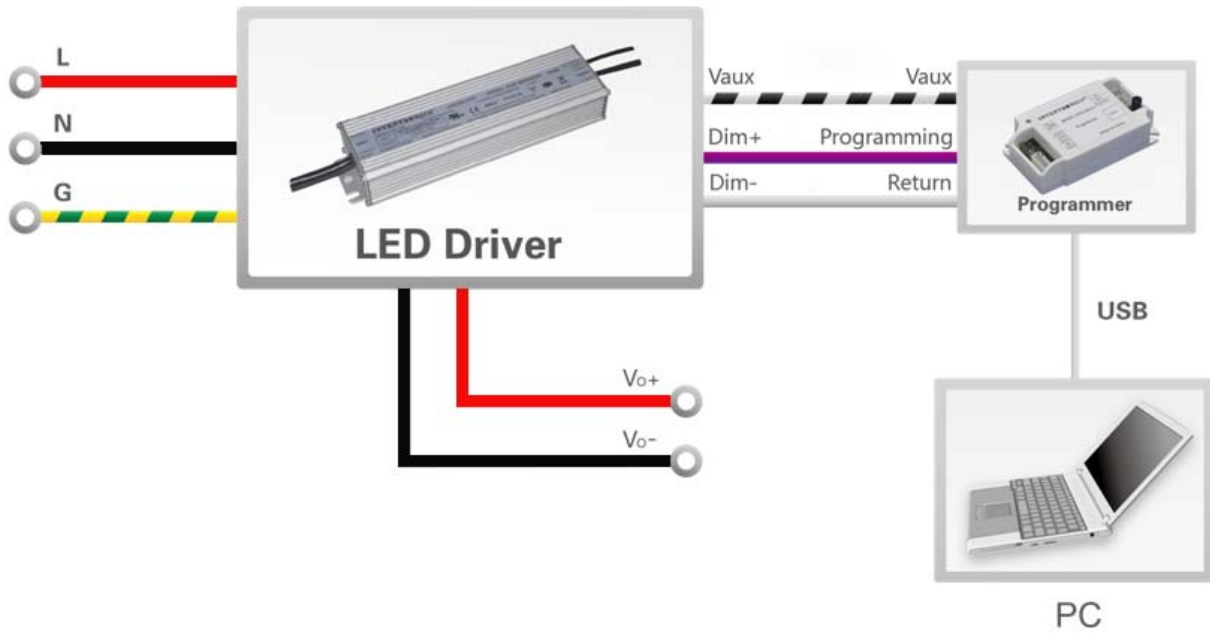

**Note:** The driver does not need to be powered on during the programming process.

- Please refer to [PRG-MUL2 \(Programmer\) datasheet](#) for details

## Mechanical Outline

EUG-075SxxxDV

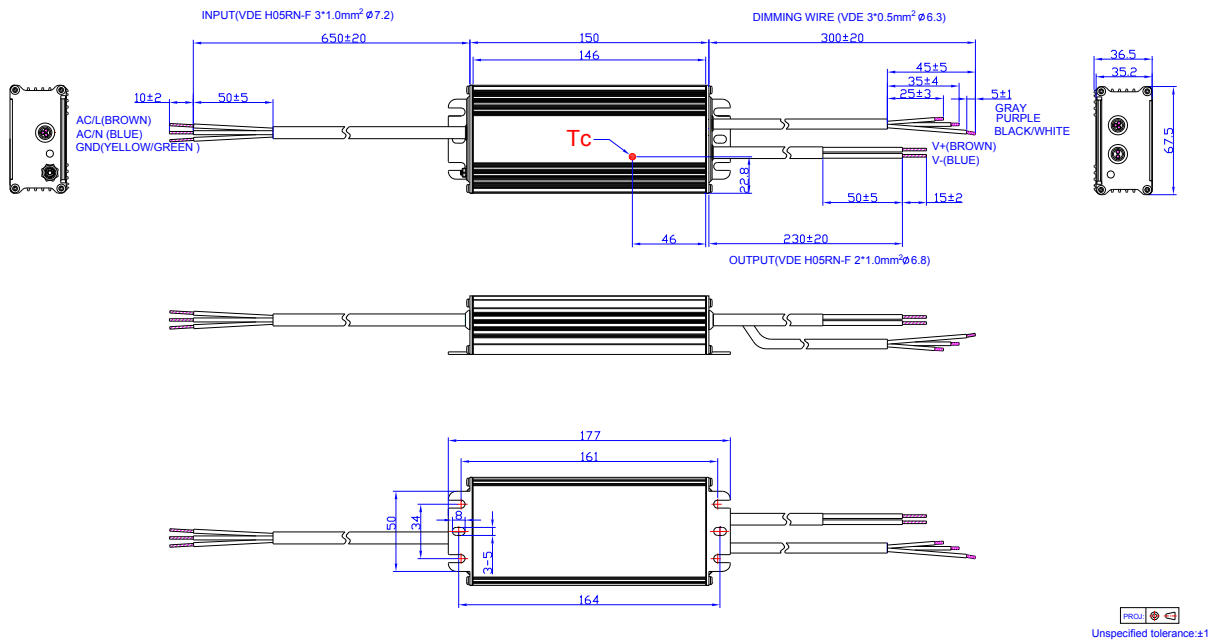

EUG-075SxxxDV-3000

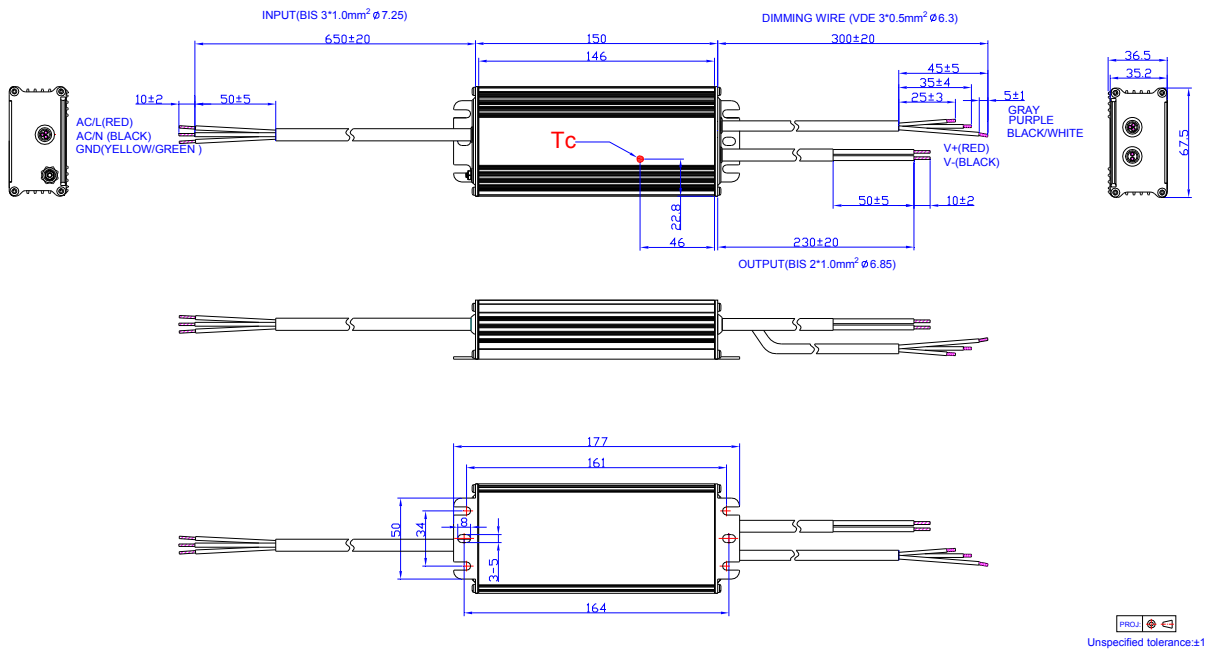

## RoHS Compliance

Our products comply with reference to RoHS Directive (EU) 2015/863 amending 2011/65/EU, calling for the elimination of lead and other hazardous substances from electronic products.

## Revision History

Change Date	Rev.	Description of Change		
		Item	From	To
2015-12-28	A	Datasheets Release	/	/
2016-04-12	B	General Specifications	Net Weight	Added
		General Specifications	With mounting ear	Added
		Safety & EMC Compliance	/	Updated
		Mechanical Outline	/	Updated
2017-07-26	C	Models	Notes	Updated
		Input Specifications	PF/THD	Updated
		Output Specifications	Temperature Coefficient of Isolet	Updated
		General Specifications	Efficiency at 277 Vac input	Updated
		Mechanical Outline	/	Updated
		Safety & EMC Compliance	/	Updated
2017-10-25	D	Features	7 Years Warranty	Added
		Operating Case Temperature for Warranty Tc_w	/	Updated
2020-03-18	E	CCC Logo	/	Updated
		KCC Logo	/	Added
		Global Mark Logo	/	Added
		Independent Logo	/	Added
		Features	6kV line-line, 10kV line-earth	DM 6kV, CM 10kV
		Features	Waterproof (IP67)	IP67
		Features	Suitable for Independent Use	Deleted
		Description	Application environment	Updated
		Models	Notes(5)	Added
		Safety & EMC Compliance	ENEC	Added
		Safety & EMC Compliance	TUV	Added
		Safety & EMC Compliance	CB	Added
		Safety & EMC Compliance	CCC	Added
		Safety & EMC Compliance	PSE	Added
Safety & EMC Compliance	BIS	Added		
Safety & EMC Compliance	Global Mark	Added		

## Revision History (Continued)

Change Date	Rev.	Description of Change		
		Item	From	To
2020-03-18	E	Safety &EMC Compliance	EN 55015 <sup>(1)</sup>	EN 55015/GB 17743/KN 15 <sup>(1)</sup>
		Safety &EMC Compliance	EN 61000-3-2	EN 61000-3-2/GB 17625.1
		Safety &EMC Compliance	EN 61000-4-5	Updated
		Dimming	/	Updated
		Programming Connection Diagram	EUG-075SxxxDV-3000	Added
		Mechanical Outline	EUG-075SxxxDV-3000	Added
		RoHS Compliance	/	Updated
		Format	Page footer	Updated