

Features

- Ultra High Efficiency (Up to 93.0%)
- Full Power at Wide Output Current Range (Constant Power)
- 0-5V/0-10V/PWM/Timer Dimmable
- Input Surge Protection: DM 6kV, CM 10kV
- All-Around Protection: OVP, SCP, OTP
- IP67 and UL Dry / Damp / Wet Location
- Class 2 & SELV Output
- TYPE HL, for use in a Class I, Division 2 hazardous (Classified) location
- UL Type TL (Temperature Limited)
- Class P, UL Listed Versions Available (See Note 6)
- 7 Years Warranty



Description

The EUG-096SxxxDT series is a 96W, constant-current, programmable LED driver that operates from 90-305 Vac input with excellent power factor. It is created for many lighting applications including low bay, tunnel and street lights. The high efficiency of these drivers and compact metal case enables them to run cooler, significantly improving reliability and extending product life. To ensure trouble-free operation, protection is provided against input surge, output over voltage, short circuit, and over temperature.

Models

Adjustable Output Current Range	Full-Power Current Range (1)	Default Output Current	Input Voltage Range(2)	Output Voltage Range	Max. Output Power	Typical Efficiency (3)	Typical Power Factor		Model Number
							120Vac	220Vac	
45-700mA	450-700mA	530 mA	90 ~ 305 Vac 100 ~ 300 Vdc	74~213Vdc	96 W	92.0%	0.99	0.96	EUG-096S070DT
70-1050mA	700-1050mA	700 mA	90 ~ 305 Vac 100 ~ 300 Vdc	48~137Vdc	96 W	93.0%	0.99	0.96	EUG-096S105DT
140-2100mA	1400-2100mA	2100 mA	90 ~ 305 Vac 100 ~ 300 Vdc	24 ~ 69Vdc	96 W	92.0%	0.99	0.96	EUG-096S210DT ⁽⁴⁾
175-2150mA	1750-2150mA	2100 mA	90 ~ 305 Vac 100 ~ 300 Vdc	24 ~ 55Vdc	96 W	91.5%	0.99	0.96	EUG-096S215DT ⁽⁵⁾
245-3500mA	2450-3500mA	2800 mA	90 ~ 305 Vac 100 ~ 300 Vdc	14 ~ 39Vdc	96 W	91.0%	0.99	0.96	EUG-096S350DT ⁽⁵⁾

Notes: (1) Output current range with constant power at 96W

(2) Certified input voltage range: UL, FCC 100-277Vac or 100-300Vdc; otherwise: 100-240Vac or 100-250Vdc. (except KS)

(3) Measured at 100% load and 220Vac input (see below “General Specifications” for details).

(4) SELV Output.

(5) Class 2 & SELV Output.

(6) Standard part UL Type TL. For UL Listed Class P models add suffix -00C0.

I-V Operation Area

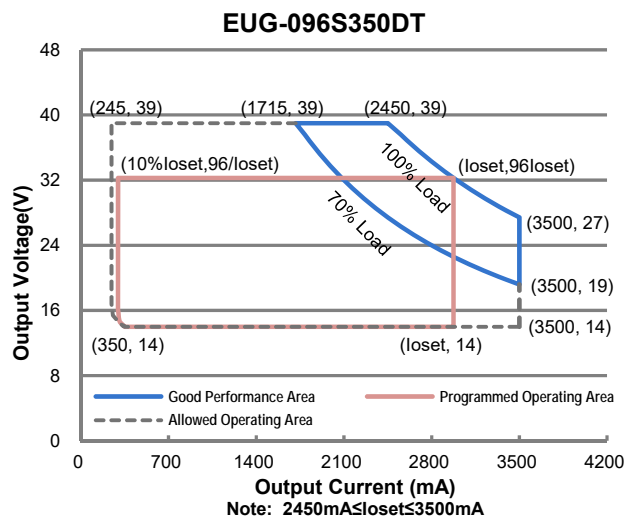
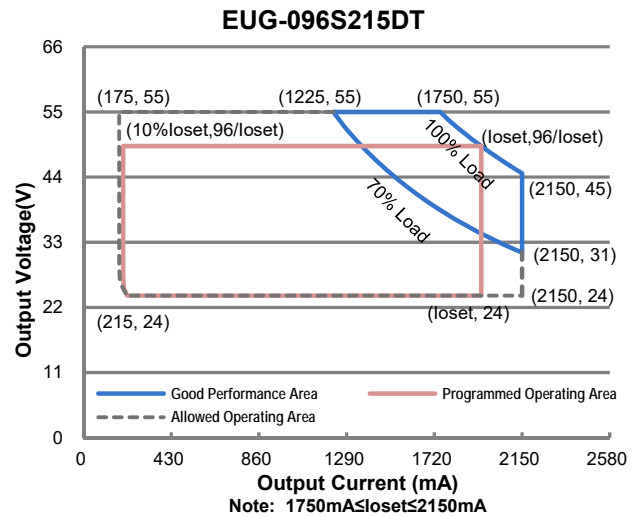
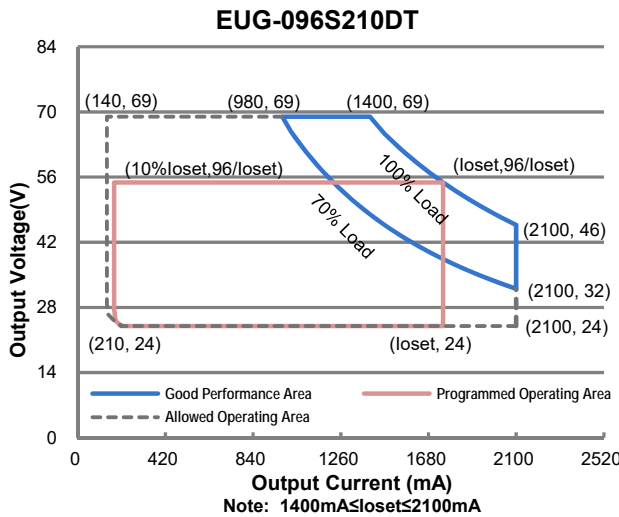
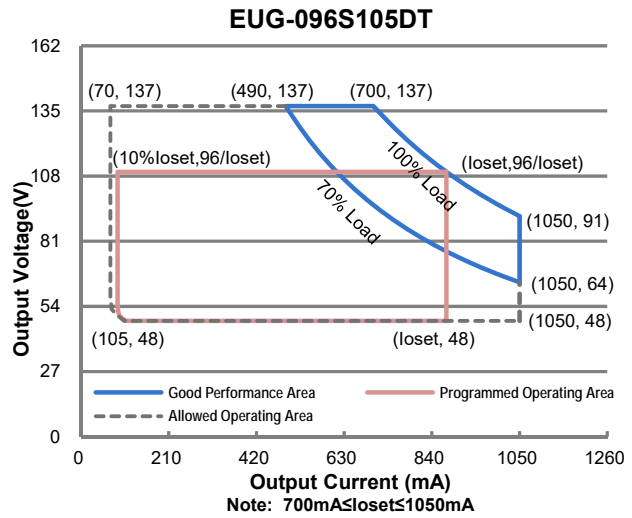
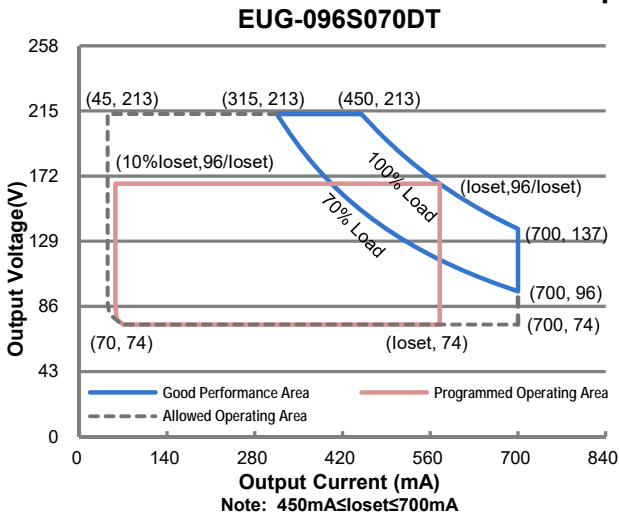

Input Specifications

Parameter	Min.	Typ.	Max.	Notes
Input AC Voltage	90 Vac	-	305 Vac	
Input DC Voltage	100 Vdc	-	300 Vdc	
Input Frequency	47 Hz	-	63 Hz	
Leakage Current	-	-	0.75 MIU	UL8750; 277Vac/ 60Hz
	-	-	0.70 mA	IEC60598-1; 240Vac/ 60Hz
Input AC Current	-	-	1.32 A	Measured at 100% load and 100 Vac input.
	-	-	0.60 A	Measured at 100% load and 220 Vac input.
Inrush Current(I ² t)	-	-	1.65 A ² s	At 220Vac input, 25°C cold start, duration=760 μs, 10%I _{pk} -10%I _{pk} . See Inrush Current Waveform for the details.
PF	0.9	-	-	At 100-277Vac, 50-60Hz, 70%-100% Load (67-96W)
THD	-	-	20%	
THD	-	-	10%	At 220-240Vac, 50-60Hz, 75%-100% Load (72-96W)

Output Specifications

Parameter	Min.	Typ.	Max.	Notes
Output Current Tolerance	-5%loset	-	5%loset	At 100% load condition
Output Current Setting(loset) Range				
EUG-096S070DT	45 mA	-	700 mA	
EUG-096S105DT	70 mA	-	1050 mA	
EUG-096S210DT	140 mA	-	2100 mA	
EUG-096S215DT	175 mA	-	2150 mA	
EUG-096S350DT	245 mA	-	3500 mA	
Output Current Setting Range with Constant Power				
EUG-096S070DT	450 mA	-	700 mA	
EUG-096S105DT	700 mA	-	1050 mA	
EUG-096S210DT	1400 mA	-	2100 mA	
EUG-096S215DT	1750 mA	-	2150 mA	
EUG-096S350DT	2450 mA	-	3500 mA	
Total Output Current Ripple (pk-pk)	-	5%I _{omax}	10%I _{omax}	At 100% load condition, 20 MHz BW
Output Current Ripple at < 200 Hz (pk-pk)	-	2%I _{omax}	-	At 100% load condition. Only this component of ripple is associated with visible flicker.
Startup Overshoot Current	-	-	10%I _{omax}	At 100% load condition
No Load Output Voltage				
EUG-096S070DT	-	-	280 V	
EUG-096S105DT	-	-	180 V	
EUG-096S210DT	-	-	90 V	
EUG-096S215DT	-	-	59 V	
EUG-096S350DT	-	-	50 V	

Output Specifications (Continued)

Parameter	Min.	Typ.	Max.	Notes
Line Regulation	-	-	±0.5%	Measured at 100% load
Load Regulation	-	-	±1.5%	
Turn-on Delay Time	-	-	1.0 s	Measured at 120Vac input, 70%-100% Load
	-	-	0.5 s	Measured at 220Vac input, 70%-100% Load
Temperature Coefficient of I _o set	-	0.03%/°C	-	Case temperature = 0°C ~T _c max
12V Auxiliary Output Voltage	10.8 V	12 V	13.2 V	
12V Auxiliary Output Source Current	0 mA	-	20 mA	Return terminal is "Dim-"

General Specifications

Parameter	Min.	Typ.	Max.	Notes
Efficiency at 120 Vac input: EUG-096S070DT				Measured at 100% load and steady-state temperature in 25°C ambient; (Efficiency will be about 2.0% lower if measured immediately after startup.)
I _o = 450mA	87.0%	90.0%	-	
I _o = 700mA	86.0%	89.0%	-	
EUG-096S105DT				
I _o = 700mA	88.5%	91.5%	-	
I _o =1050mA	87.0%	90.0%	-	
EUG-096S210DT				
I _o =1400mA	87.0%	90.0%	-	
I _o =2100mA	87.0%	90.0%	-	
EUG-096S215DT				
I _o =1750mA	87.0%	90.0%	-	
I _o =2150mA	86.5%	89.5%	-	
EUG-096S350DT				
I _o =2450mA	86.0%	89.0%	-	
I _o =3500mA	85.5%	88.5%	-	
Efficiency at 220 Vac input: EUG-096S070DT				Measured at 100% load and steady-state temperature in 25°C ambient; (Efficiency will be about 2.0% lower if measured immediately after startup.)
I _o = 450mA	90.0%	92.0%	-	
I _o = 700mA	89.0%	91.0%	-	
EUG-096S105DT				
I _o = 700mA	91.0%	93.0%	-	
I _o =1050mA	89.0%	91.0%	-	
EUG-096S210DT				
I _o =1400mA	89.5%	91.5%	-	
I _o =2100mA	90.0%	92.0%	-	
EUG-096S215DT				
I _o =1750mA	89.5%	91.5%	-	
I _o =2150mA	89.5%	91.5%	-	
EUG-096S350DT				
I _o =2450mA	89.0%	91.0%	-	
I _o =3500mA	88.0%	90.0%	-	

General Specifications (Continued)

Parameter	Min.	Typ.	Max.	Notes
Efficiency at 277 Vac input: EUG-096S070DT I _o = 450mA I _o = 700mA EUG-096S105DT I _o = 700mA I _o =1050mA EUG-096S210DT I _o =1400mA I _o =2100mA EUG-096S215DT I _o =1750mA I _o =2150mA EUG-096S350DT I _o =2450mA I _o =3500mA	90.5% 89.0% 91.5% 89.5% 90.0% 90.5% 90.0% 90.0% 89.5% 88.5%	92.5% 91.0% 93.5% 91.5% 92.0% 92.5% 92.0% 92.0% 91.5% 90.5%	- - - - - - - - - -	Measured at 100% load and steady-state temperature in 25°C ambient; (Efficiency will be about 2.0% lower if measured immediately after startup.)
MTBF	-	339,000 Hours	-	Measured at 220Vac input, 80%Load and 25°C ambient temperature (MIL-HDBK-217F)
Lifetime	-	98,000 Hours	-	Measured at 220Vac input, 80%Load and 70°C case temperature; See lifetime vs. Tc curve for the details
Operating Case Temperature for Safety Tc _s	-40°C	-	+90°C	
Operating Case Temperature for Warranty Tc _w	-40°C	-	+75°C	Case temperature for 7 years warranty. <i>Please see Inventronics Warranty Statement for complete details.</i> Humidity: 10%RH to 95%RH
Operating Case Temperature for Type TL Tc _{TL}	-40°C	-	+64°C	Only UL Type TL models
Storage Temperature	-40°C	-	+85°C	Humidity: 5%RH to 95%RH
Dimensions Inches (L × W × H) Millimeters (L × W × H)	6.85 × 2.66 × 1.44 174 × 67.5 × 36.5			With mounting ear 7.92 × 2.66 × 1.44 201 × 67.5 × 36.5
Net Weight	-	890 g	-	

Dimming Specifications

Parameter	Min.	Typ.	Max.	Notes	
Absolute Maximum Voltage on the Vdim (+) Pin	-20 V	-	20 V		
Source Current on Vdim (+)Pin	200 uA	300 uA	450 uA	Vdim(+) = 0 V	
Dimming Output Range	EUG-096S070DT EUG-096S105DT EUG-096S210DT EUG-096S215DT EUG-096S350DT	10%I _o set	-	I _o set	450mA ≤ I _o set ≤ 700mA 700mA ≤ I _o set ≤ 1050mA 1400mA ≤ I _o set ≤ 2100mA 1750mA ≤ I _o set ≤ 2150mA 2450mA ≤ I _o set ≤ 3500mA
	EUG-096S070DT EUG-096S105DT EUG-096S210DT EUG-096S215DT EUG-096S350DT	45mA 70mA 140mA 175mA 245mA	-	I _o set	45mA ≤ I _o set < 450mA 70mA ≤ I _o set < 700mA 140mA ≤ I _o set < 1400mA 175mA ≤ I _o set < 1750mA 245mA ≤ I _o set < 2450mA

Dimming Specifications (Continued)

Parameter	Min.	Typ.	Max.	Notes
Recommended Dimming Range for 0-5V	0 V	-	5 V	Dimming mode set to 0-5V in PC interface.
Recommended Dimming Range for 0-10V	0 V	-	10 V	Default 0-10V dimming mode with positive logic.
PWM_in High Level	3 V	-	10 V	Dimming mode set to PWM in PC interface.
PWM_in Low Level	-0.3 V	-	0.6 V	
PWM_in Frequency Range	200 Hz	-	2 KHz	
PWM_in Duty Cycle	1%	-	99%	

Safety & EMC Compliance

Safety Category	Standard
UL/CUL	UL 8750, UL 1310, CAN/CSA-C22.2 No. 250.13, CAN/CSA-C22.2 No. 223-M91
CE	EN 61347-1, EN 61347-2-13
KS	KS C 7655
EMI Standards	Notes
EN 55015 ⁽¹⁾	Conducted emission Test & Radiated emission Test
EN 61000-3-2	Harmonic current emissions
EN 61000-3-3	Voltage fluctuations & flicker
FCC Part 15 ⁽¹⁾	ANSI C63.4 Class B
	This device complies with Part 15 of the FCC Rules. Operation is subject to the following two conditions: [1] this device may not cause harmful interference, and [2] this device must accept any interference received, including interference that may cause undesired Operation.
EMS Standards	Notes
EN 61000-4-2	Electrostatic Discharge (ESD): 8 kV air discharge, 4 kV contact discharge
EN 61000-4-3	Radio-Frequency Electromagnetic Field Susceptibility Test-RS
EN 61000-4-4	Electrical Fast Transient / Burst-EFT
EN 61000-4-5	Surge Immunity Test: AC Power Line: Differential Mode 6 kV, Common Mode 10 kV ⁽²⁾
EN 61000-4-6	Conducted Radio Frequency Disturbances Test-CS
EN 61000-4-8	Power Frequency Magnetic Field Test
EN 61000-4-11	Voltage Dips
EN 61547	Electromagnetic Immunity Requirements Applies To Lighting Equipment

Note: (1) This LED driver meets the EMI specifications above, but EMI performance of a luminaire that contains it depends also on the other devices connected to the driver and on the fixture itself.

(2) To perform electric strength (hi-pot) testing, the "GDT ground disconnect" (nut and metal lock sheet) on the driver end-cap should be removed temporarily to prevent the internal gas discharge tube from conducting (as allowed by IEC 60598-1 Clause 10.2). After testing is completed, these items must be reinstalled to restore line-to-earth surge protection and secure the end cap.

Lifetime vs. Case Temperature

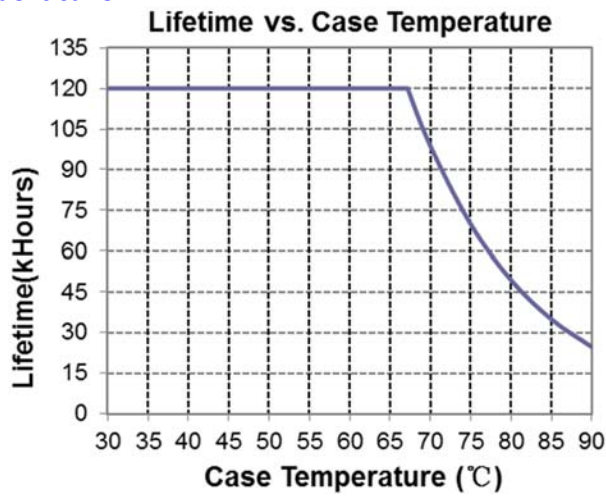

Inrush Current Waveform

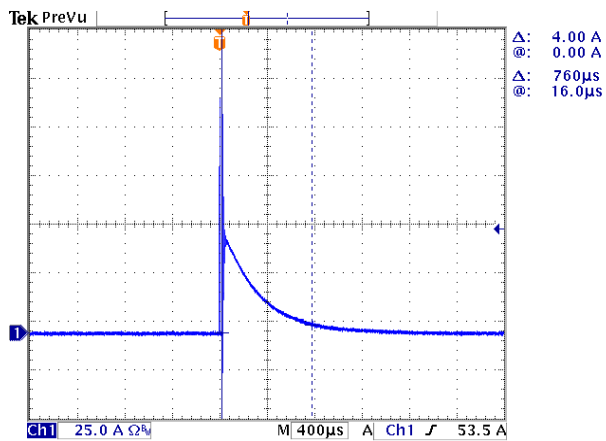

Efficiency vs. Load

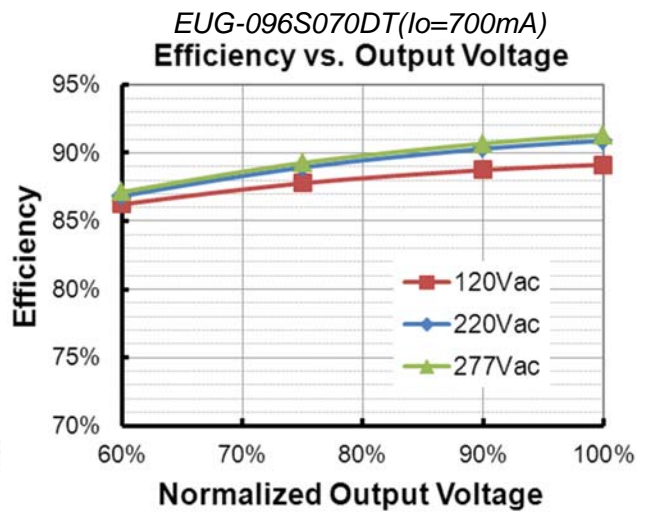
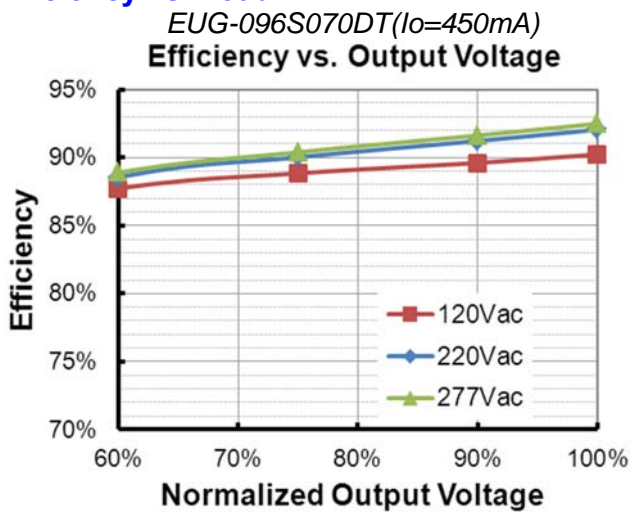

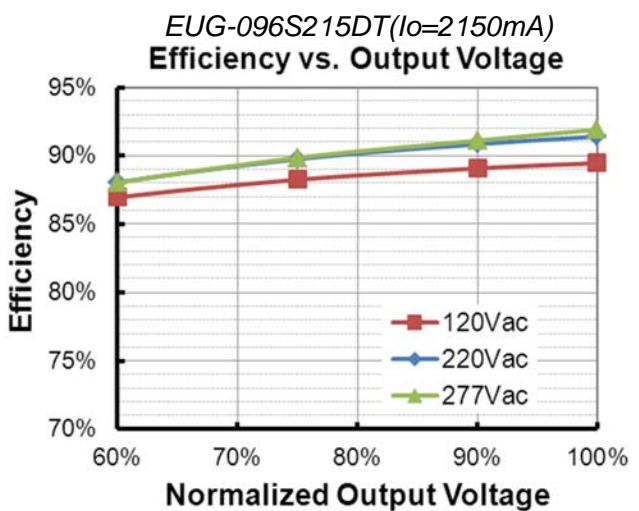
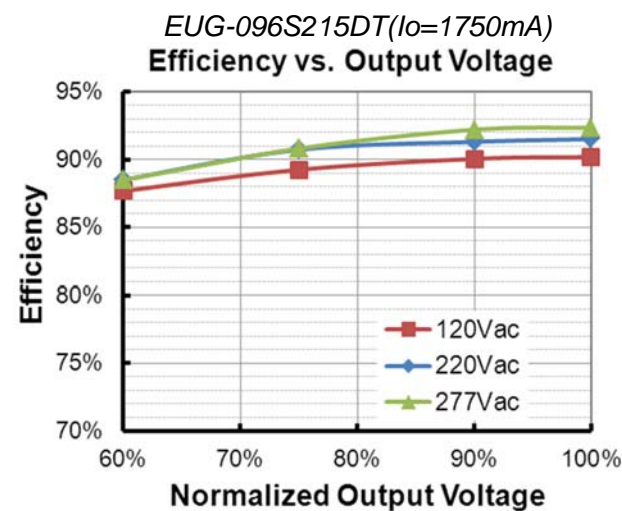
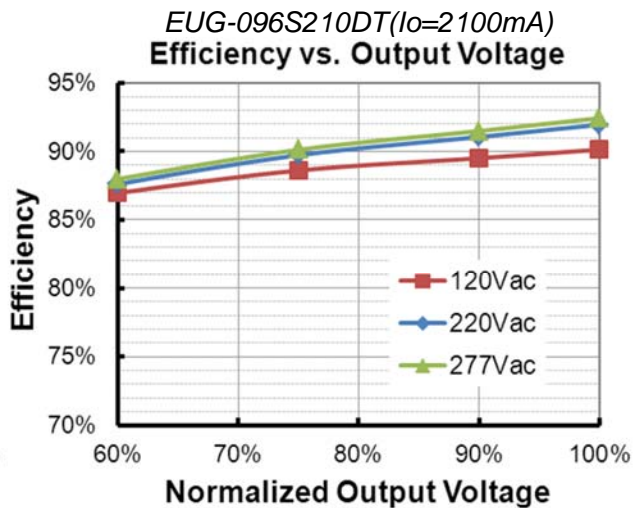
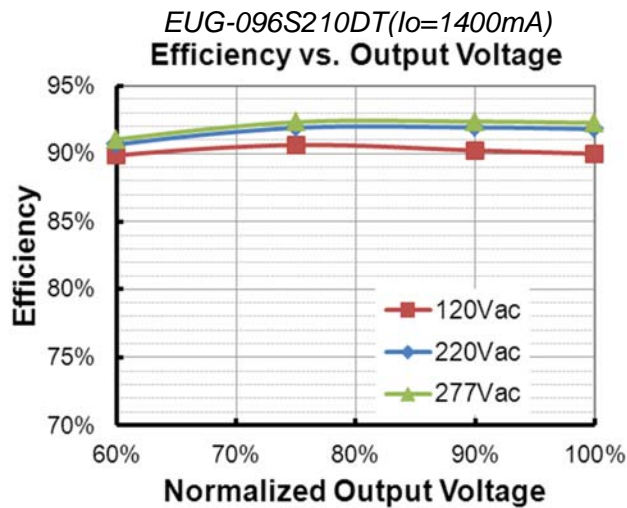
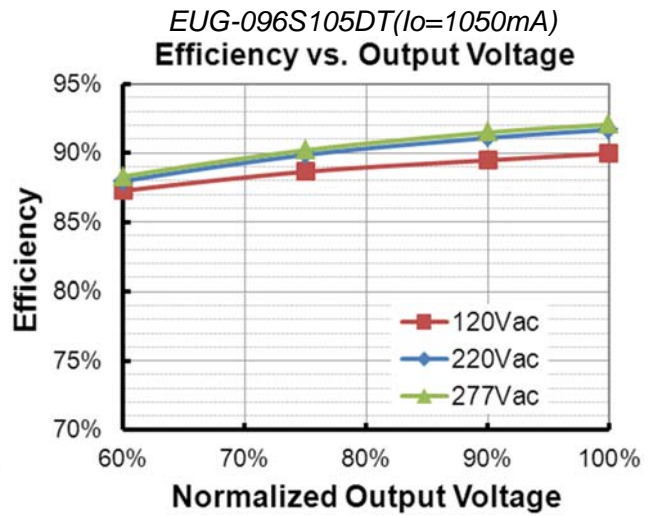
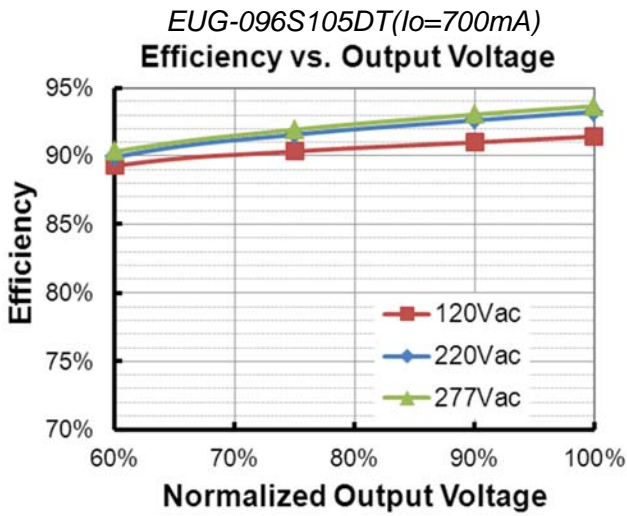

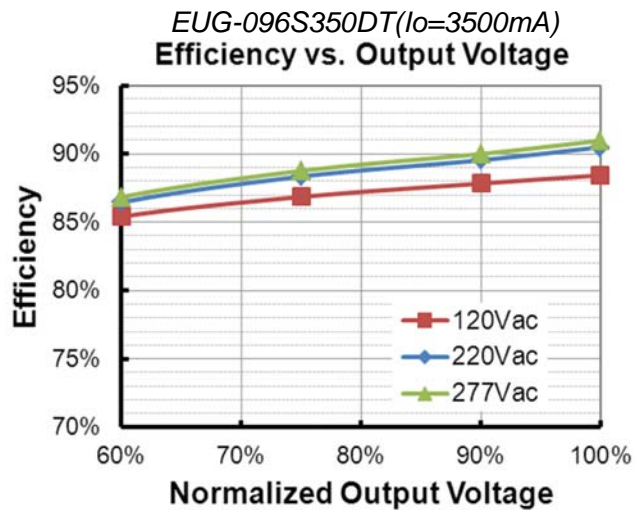
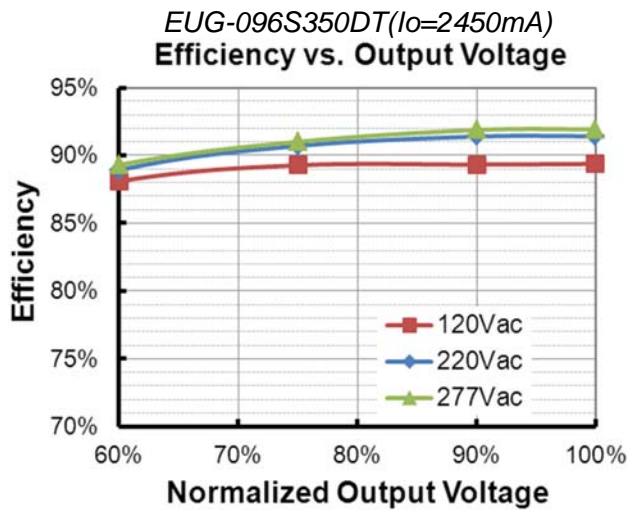

Power Factor

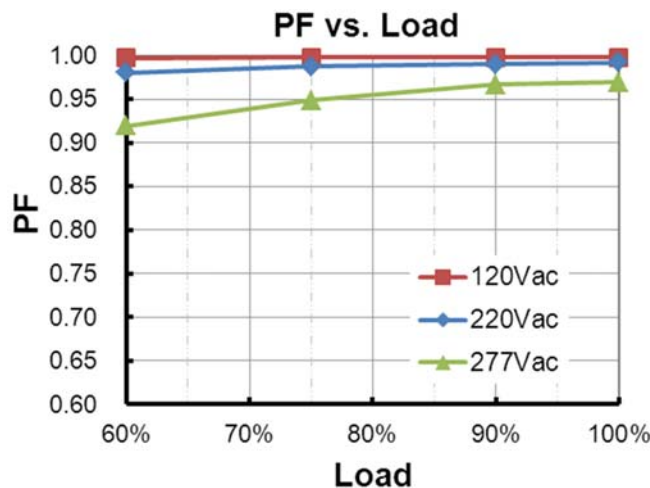

Total Harmonic Distortion

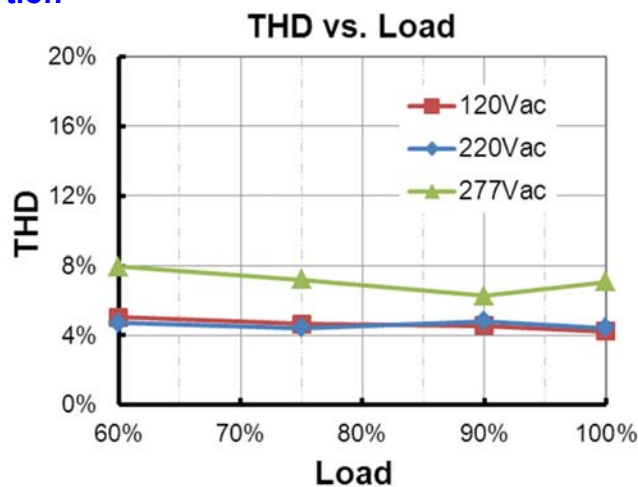

Protection Functions

Parameter	Notes
Over Temperature Protection	Decreases output current, returning to normal after over temperature is removed.
Short Circuit Protection	Auto Recovery. No damage will occur when any output is short circuited. The output shall return to normal when the fault condition is removed.
Over Voltage Protection	Limits output voltage at no load and in case the normal voltage limit fails.

Dimming

● 0-5V Dimming

The recommended implementation of the dimming control is provided below.

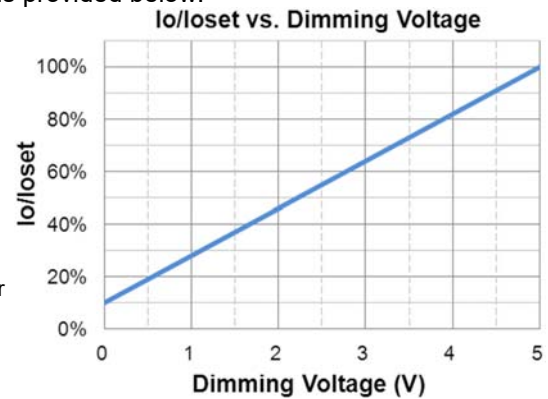
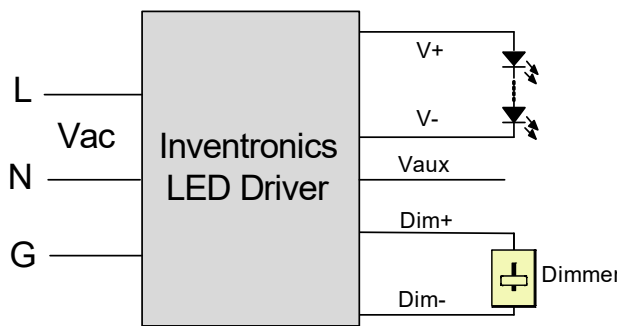

Implementation 1: Positive logic

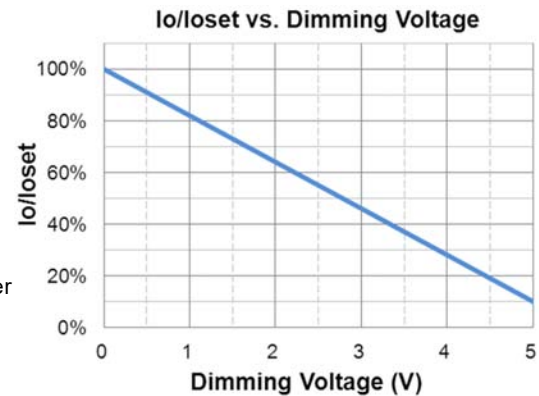
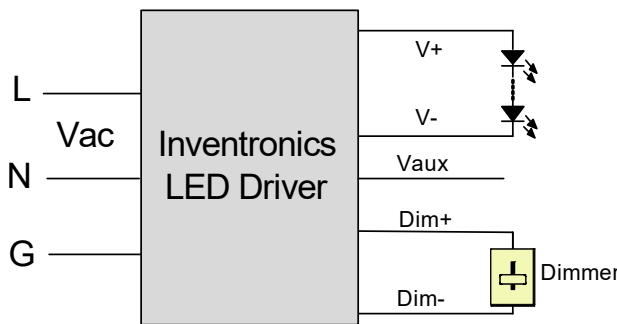

Implementation 2: Negative logic

Notes:

1. Do NOT connect Dim- to the output V- or V+, otherwise the driver will not work properly.
2. The dimmer can also be replaced by an active 0-5V voltage source signal or passive components like zener.
3. When 0-5V negative logic dimming mode and Dim+ is open, the driver will output maximum current.

● 0-10V Dimming

The recommended implementation of the dimming control is provided below.

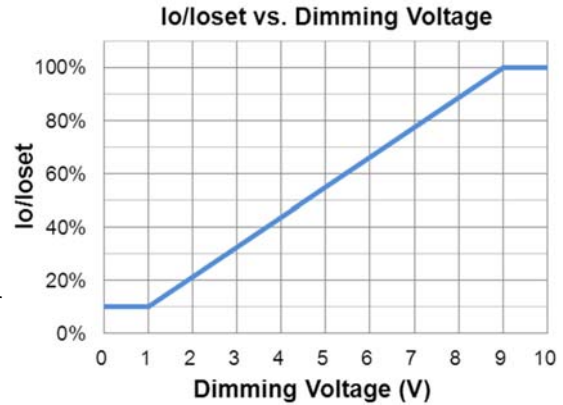
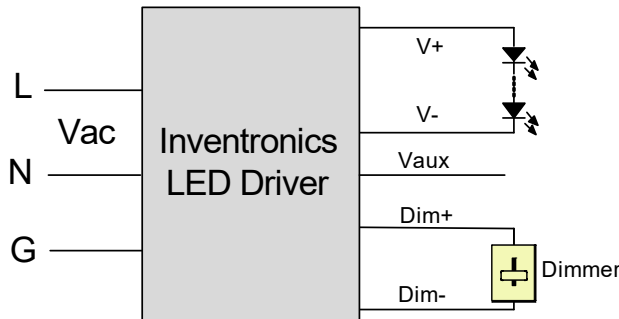

Implementation 3: Positive logic

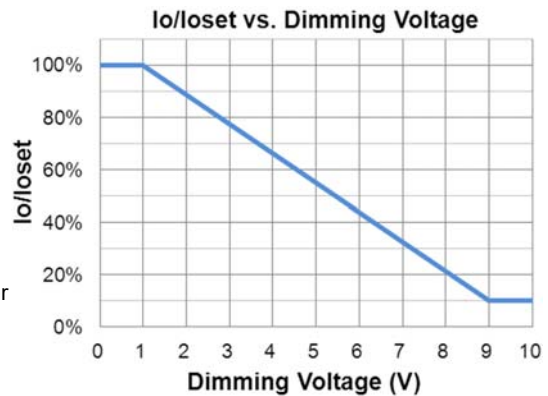
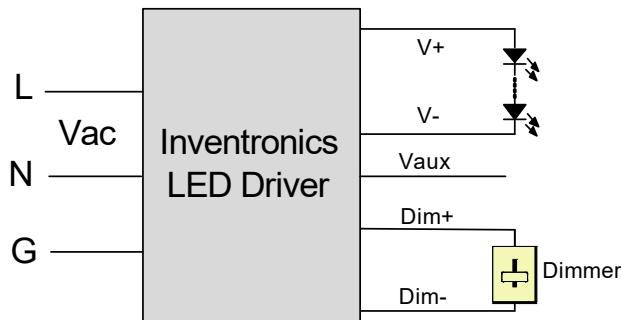

Implementation 4: Negative logic

Notes:

1. Do NOT connect Dim- to the output V- or V+, otherwise the driver will not work properly.
2. The dimmer can also be replaced by an active 0-10V voltage source signal or passive components like zener.
3. When 0-10V negative logic dimming mode and Dim+ is open, the driver will output minimum current.

● PWM Dimming

The recommended implementation of the dimming control is provided below.

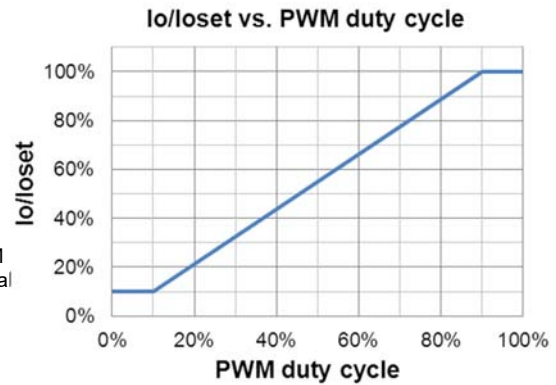
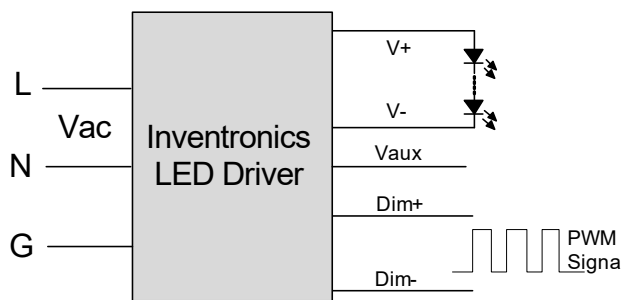

Implementation 5: Positive logic

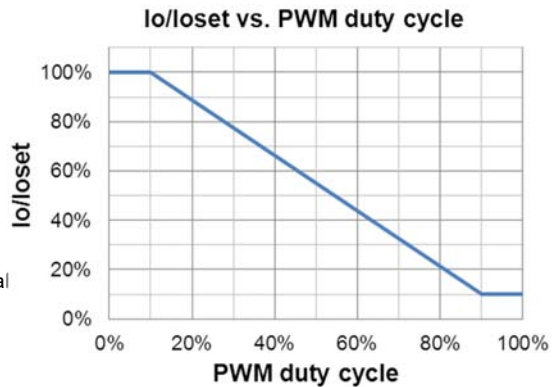
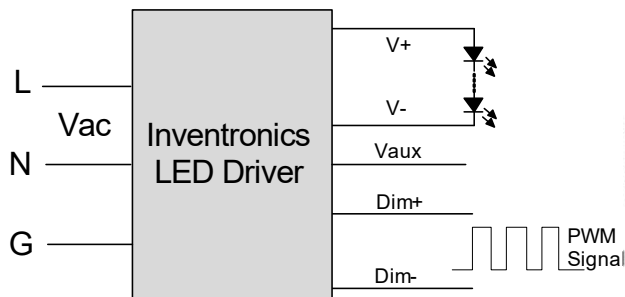

Implementation 6: Negative logic

Notes:

1. Do NOT connect Dim- to the output V- or V+, otherwise the driver will not work properly.
2. When PWM negative logic dimming mode and Dim+ is open, the driver will output minimum current.

● Time Dimming

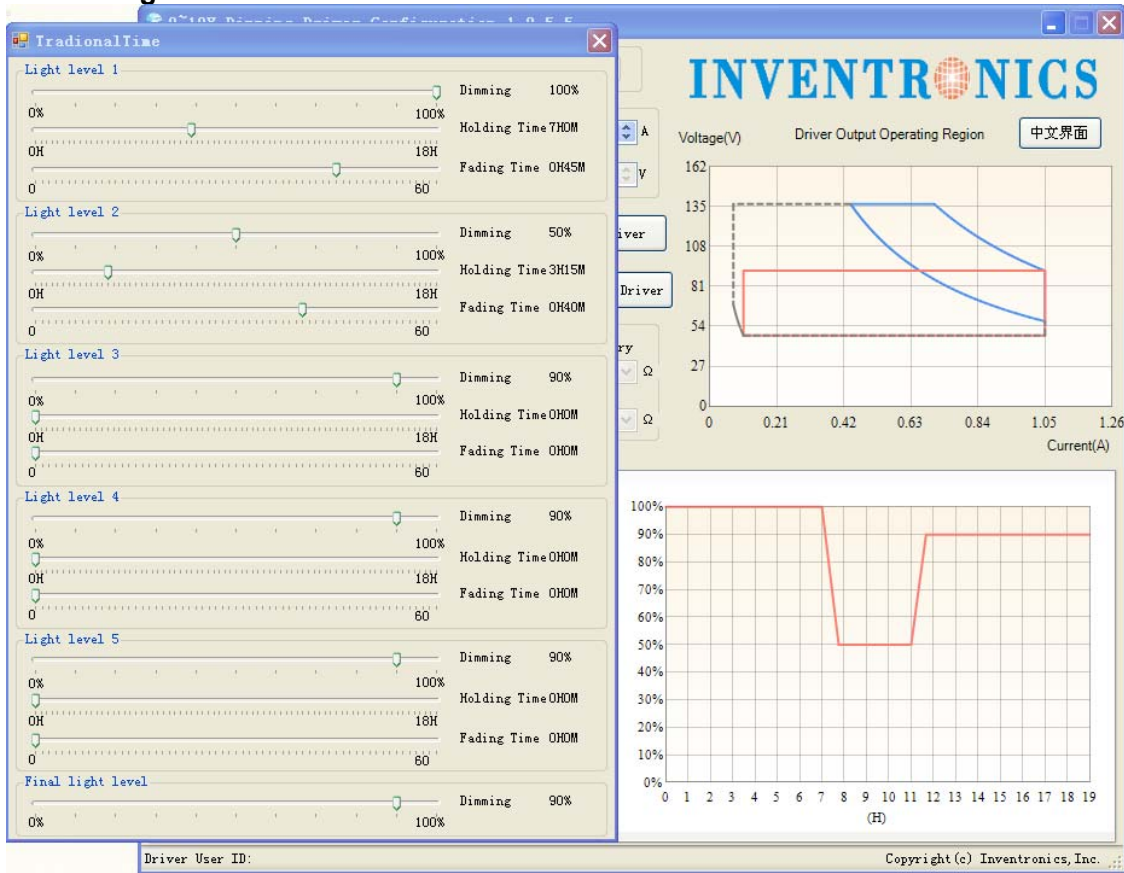

Set the timing curve by pulling the sliders.

Programming Connection Diagram

EUG-096SxxxDT

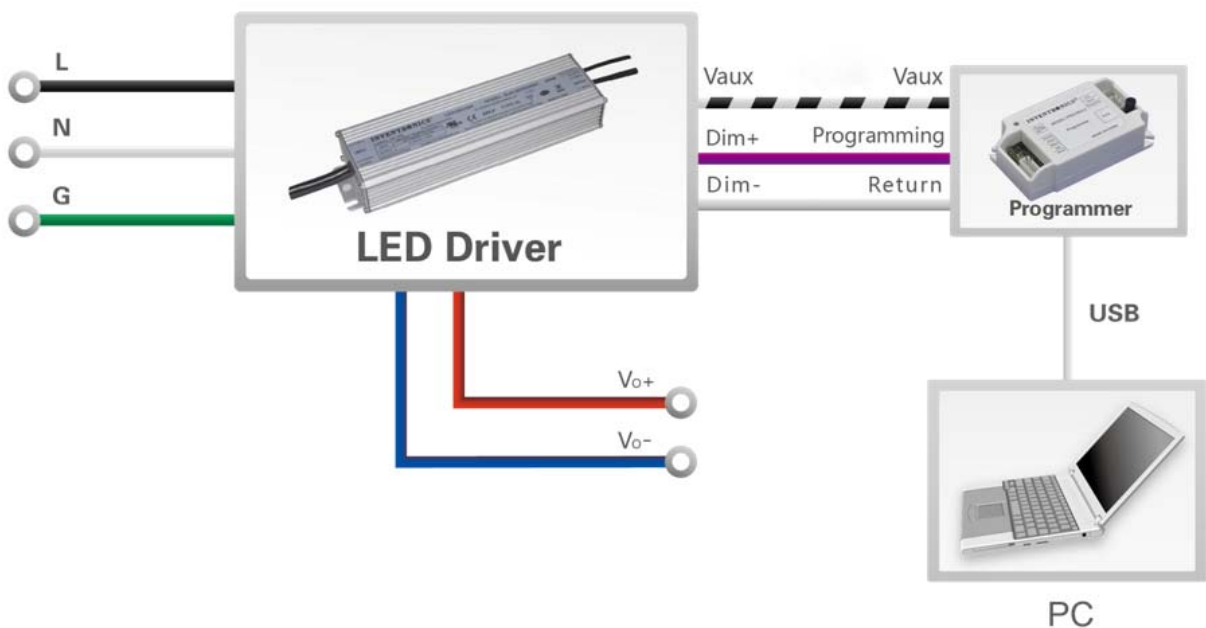

EUG-096SxxxDT-00C0

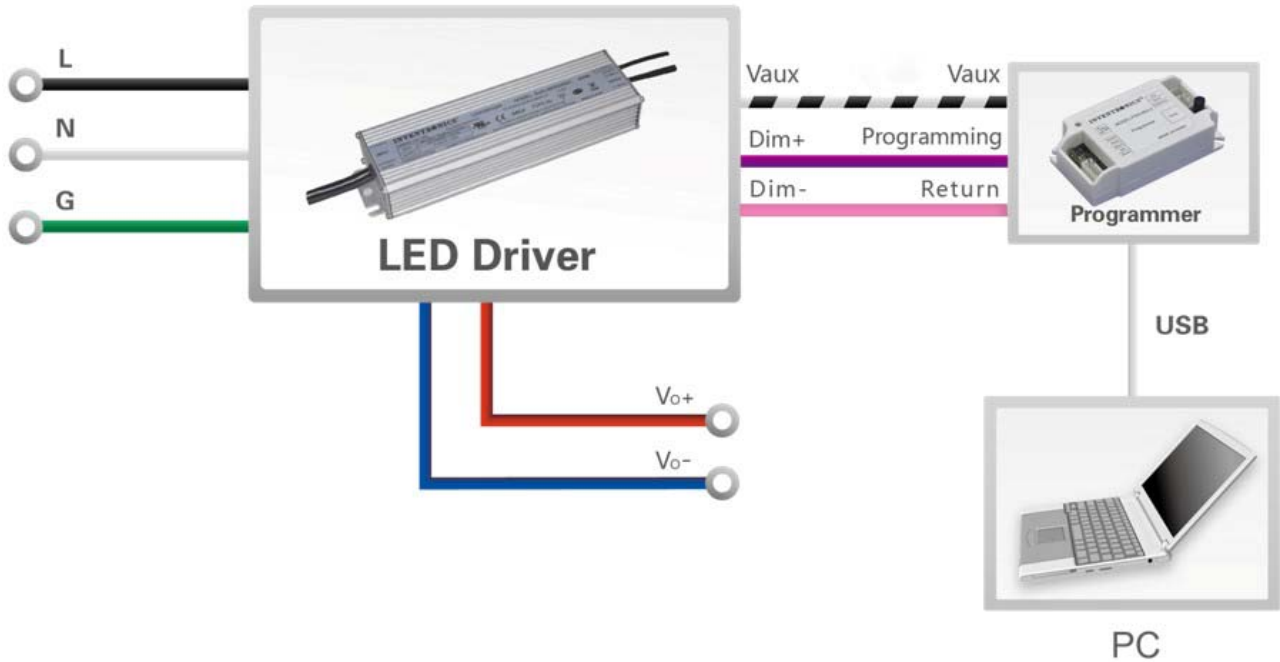

Note: The driver does not need to be powered on during the programming process.

- Please refer to [PRG-MUL2 \(Programmer\) datasheet](#) for details.

Mechanical Outline

EUG-096SxxxDT

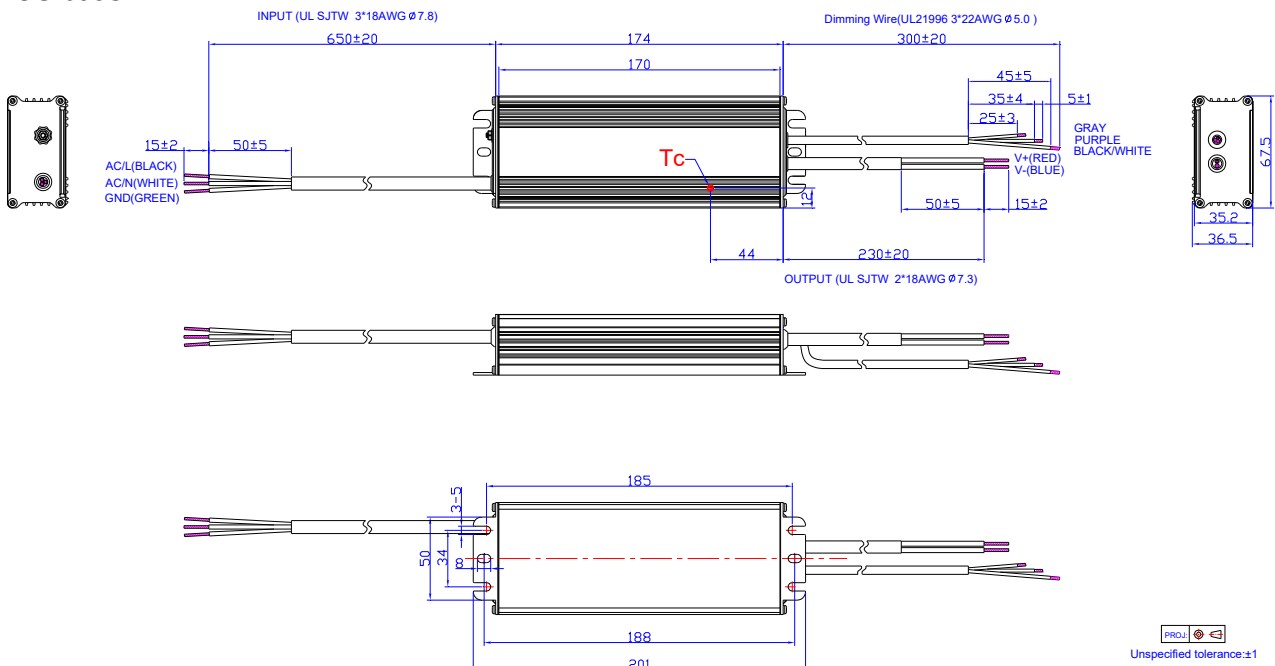

EUG-096SxxxDT-00C0

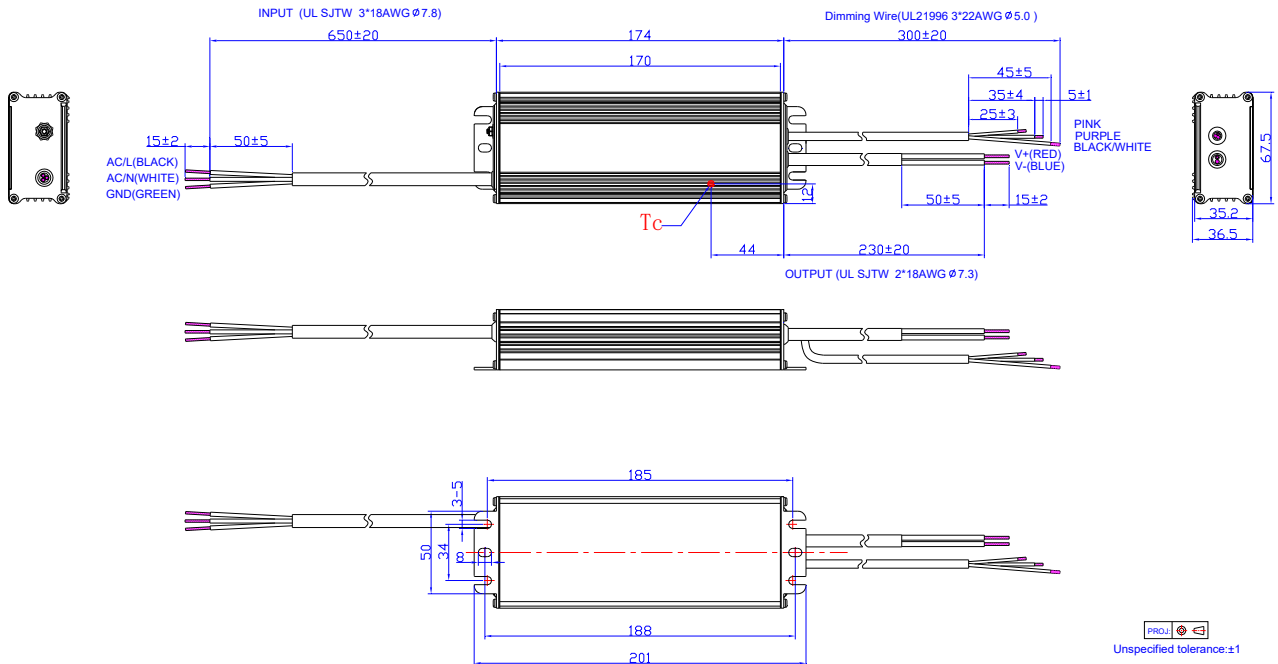

RoHS Compliance

Our products comply with reference to RoHS Directive (EU) 2015/863 amending 2011/65/EU, calling for the elimination of lead and other hazardous substances from electronic products.

Revision History

Change Date	Rev.	Description of Change		
		Item	From	To
2015-07-08	A	Datasheets Release	/	/
2016-03-03	B	EUG-096S070DT	/	Added
		Net Weight	/	Updated
		Safety & EMC Compliance	KS	Added
		Mechanical Outline	/	Updated
2017-03-30	C	EUG-096S215DT	/	Added
		I-V Operation Area	EUG-096S215DT	Added
		Output Specifications	Output Current Setting(losset) Range	Updated
		Output Specifications	Output Current Setting Range with Constant Power	Updated
		Output Specifications	No Load Output Voltage	Updated
		General Specifications	Efficiency at 120 Vac input	Updated
		General Specifications	Efficiency at 220 Vac input	Updated
		General Specifications	Efficiency at 277 Vac input	Updated
		General Specifications	Dimensions	Updated
		Dimming Specifications	Dimming Output Range	Updated
		Safety & EMC Compliance	/	Updated
		Efficiency vs. Load	EUG-096S215DT	Added
		Programming Connection Diagram	/	Updated
		Mechanical Outline	/	Updated
2017-07-27	D	Input Specifications	PF/ THD	Updated
2017-10-26	E	Features	Class P, UL Listed Versions Available (See Note 6)	Added
		Features	7 Years Warranty	Added
		Models	(6) Standard part UL Type TL. For UL Listed Class P models add suffix -00C0.	Added
		Operating Case Temperature for Warranty Tc_w	/	Updated
		Operating Case Temperature for Type TL Tc_TL	Only UL Type TL models	Added
2018-01-31	F	Description	/	Updated
		General Specifications	Lifetime	Updated

Revision History (Continued)

Change Date	Rev.	Description of Change		
		Item	From	To
2018-01-31	F	General Specifications	Operating Case Temperature for Warranty	Updated
		Lifetime vs. Case Temperature	/	Updated
2022-02-25	G	Features	/	Updated
		Programming Connection Diagram	/	Updated
		Mechanical Outline	/	Updated