

Features

- High Efficiency (Up to 92%)
- Full Power at Wide Output Current Range (Constant Power)
- 0-10V/10V PWM Dimmable (DT models)
3 Timer Modes Dimmable (TT models)
- Input Surge Protection: 6kV line-line, 10kV line-earth
- All-Around Protection: OVP, SCP, OTP
- Waterproof (IP67) and UL Dry / Damp / Wet Location
- Class 2 & SELV Output
- TYPE HL, for use in a Class I, Division 2 hazardous (Classified) location
- 5 Years Warranty



Description

The EUK-096SxxxDT(TT) series is a 96W, constant-current, programmable IP67 LED driver that operates from 90-305 Vac input with excellent power factor. It is created for many lighting applications including high bay, tunnel and street. The high efficiency of these drivers and compact metal case enables them to run cooler, significantly improving reliability and extending product life. To ensure trouble-free operation, protection is provided against input surge, output over voltage, short circuit, and over temperature.

Models

Adjustable Output Current Range	Full-Power Current Range (1)	Default Output Current	Input Voltage Range(2)	Output Voltage Range	Max. Output Power	Typical Efficiency (3)	Power Factor		Model Number
							120Vac	220Vac	
70-1050mA	700-1050mA	700 mA	90~305 Vac/ 127~300 Vdc	48~137Vdc	96 W	92.0%	0.99	0.96	EUK-096S105DT(TT)
105-1500mA	1050-1500mA	1050 mA	90~305 Vac/ 127~300 Vdc	32 ~ 91Vdc	96 W	91.0%	0.99	0.96	EUK-096S150DT(TT)
140-2100mA	1400-2100mA	2100 mA	90~305 Vac/ 127~300 Vdc	24 ~ 69Vdc	96 W	91.0%	0.99	0.96	EUK-096S210DT(TT) ⁽⁴⁾
245-3500mA	2450-3500mA	2800 mA	90~305 Vac/ 127~300 Vdc	14 ~ 39Vdc	96 W	89.0%	0.99	0.96	EUK-096S350DT(TT) ⁽⁵⁾

Notes: (1) Output current range with constant power at 96W

(2) Certified input voltage range: UL, FCC 100-277Vac or 127-300Vdc; otherwise 100-240Vac or 127-250Vdc (except KS).

(3) Measured at 100% load and 220Vac input (see below "General Specifications" for details).

(4) SELV Output

(5) Class 2 & SELV Output

I-V Operation Area

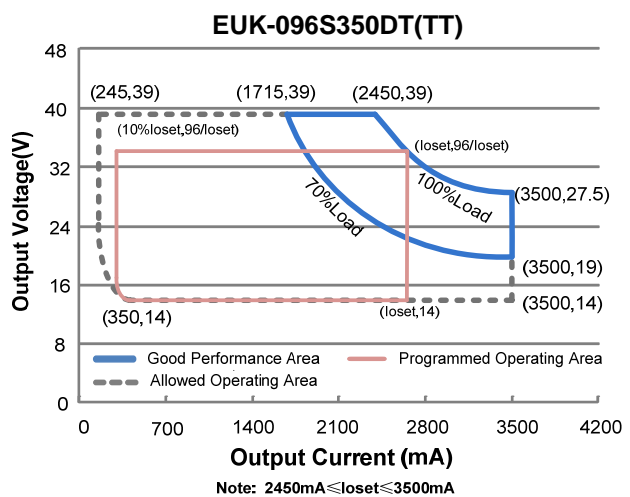
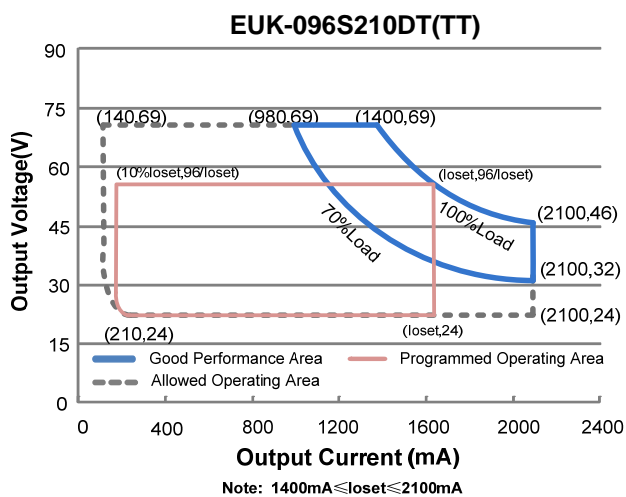
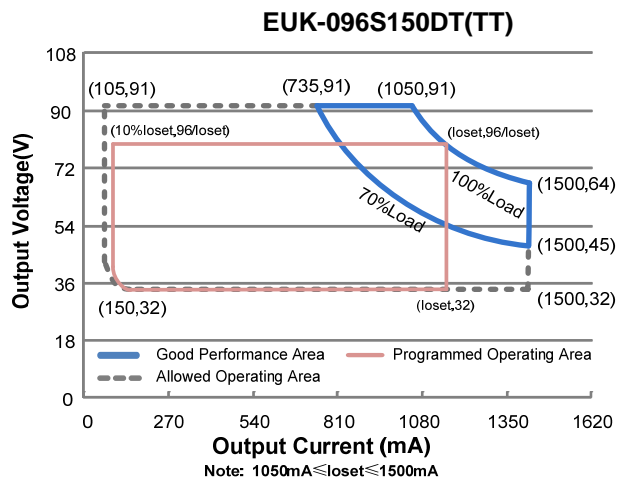
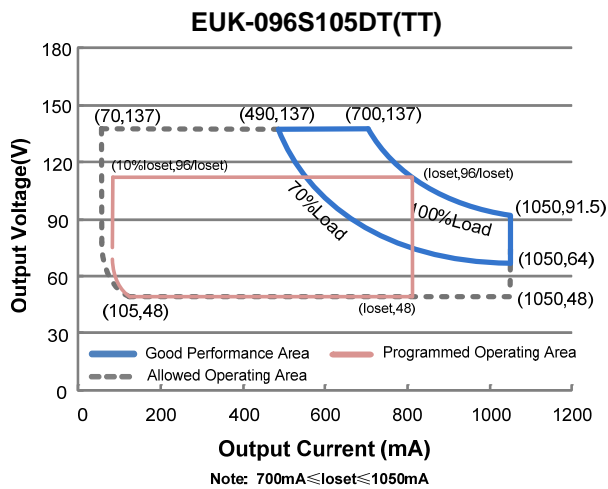

Input Specifications

Parameter	Min.	Typ.	Max.	Notes
Input Voltage	90 Vac	-	305 Vac	127~300 Vdc
Input Frequency	47 Hz	-	63 Hz	
Leakage Current	-	-	0.75 MIU	UL8750; 277Vac/ 60Hz
	-	-	0.70 mA	IEC60598-1; 240Vac/ 60Hz,
Input AC Current	-	-	0.95 A	Measured at 100% load and 120 Vac input.
	-	-	0.51 A	Measured at 100% load and 220 Vac input.
Inrush Current(I ² t)	-	-	1.20 A ² s	At 220Vac input, 25°C cold start, duration=344 us, 10%Ipk-10%Ipk. See Inrush Current Waveform for the details.

Input Specifications (Continued)

Parameter	Min.	Typ.	Max.	Notes
PF	0.9	-	-	At 100-277Vac, 50-60Hz, 70%-100% Load (67-96W)
THD	-	-	20%	
THD	-	-	10%	At 220-240Vac, 50-60Hz, 75%-100% Load (72-96W)

Output Specifications

Parameter	Min.	Typ.	Max.	Notes
Output Current Tolerance	-5%loset	-	5%loset	100% load
Output Current Setting(loset) Range				
EUK-096S105DT(TT)	70 mA	-	1050 mA	
EUK-096S150DT(TT)	105 mA	-	1500 mA	
EUK-096S210DT(TT)	140 mA	-	2100 mA	
EUK-096S350DT(TT)	245 mA	-	3500 mA	
Output Current Setting Range with Constant Power				
EUK-096S105DT(TT)	700 mA	-	1050 mA	
EUK-096S150DT(TT)	1050 mA	-	1500 mA	
EUK-096S210DT(TT)	1400 mA	-	2100 mA	
EUK-096S350DT(TT)	2450 mA	-	3500 mA	
Total Output Current Ripple (pk-pk)	-	5%lomax	10%lomax	100% load. 20 MHz BW
Output Current Ripple at < 200 Hz (pk-pk)	-	2%lomax	-	100% load
Startup Overshoot Current	-	-	10%lomax	100% load
No Load Output Voltage				
EUK-096S105DT(TT)	-	-	160 V	
EUK-096S150DT(TT)	-	-	110 V	
EUK-096S210DT(TT)	-	-	89 V	
EUK-096S350DT(TT)	-	-	49 V	
Line Regulation	-	-	±5%	100% load
Load Regulation	-	-	±5%	
Turn-on Delay Time	-	-	1.0 s	Measured at 120Vac input, 70%-100% Load
	-	-	0.5 s	Measured at 220Vac input, 70%-100% Load
Temperature Coefficient of loset	-	0.06%/°C	-	Case temperature = 0°C ~Tc max

Note: All specifications are typical at 25°C unless otherwise stated.

General Specifications

Parameter	Min.	Typ.	Max.	Notes
Efficiency at 120 Vac input: EUK-096S105DT(TT) I _o = 700 mA I _o =1050 mA EUK-096S150DT(TT) I _o =1050 mA I _o =1500 mA EUK-096S210DT(TT) I _o =1400 mA I _o =2100 mA EUK-096S350DT(TT) I _o =2450 mA I _o =3500 mA	87.5% 87.5% 87.0% 87.0% 86.5% 87.0% 84.5% 84.5%	89.5% 89.5% 89.0% 89.0% 88.5% 89.0% 86.5% 86.5%	- - - - - - - -	Measured at 100% load and steady-state temperature in 25°C ambient; (Efficiency will be about 2.0% lower if measured immediately after startup.)
Efficiency at 220 Vac input: EUK-096S105DT(TT) I _o = 700 mA I _o =1050 mA EUK-096S150DT(TT) I _o =1050 mA I _o =1500 mA EUK-096S210DT(TT) I _o =1400 mA I _o =2100 mA EUK-096S350DT(TT) I _o =2450 mA I _o =3500 mA	89.5% 90.0% 88.5% 89.0% 88.5% 89.0% 87.0% 86.5%	91.5% 92.0% 90.5% 91.0% 90.5% 91.0% 89.0% 88.5%	- - - - - - - -	Measured at 100% load and steady-state temperature in 25°C ambient; (Efficiency will be about 2.0% lower if measured immediately after startup.)
Efficiency at 277 Vac input: EUK-096S105DT(TT) I _o = 700 mA I _o =1050 mA EUK-096S150DT(TT) I _o =1050 mA I _o =1500 mA EUK-096S210DT(TT) I _o =1400 mA I _o =2100 mA EUK-096S350DT(TT) I _o =2450 mA I _o =3500 mA	89.5% 90.0% 89.5% 90.0% 89.0% 89.0% 87.5% 87.0%	91.5% 92.0% 91.5% 92.0% 91.0% 91.0% 89.5% 89.0%	- - - - - - - -	Measured at 100% load and steady-state temperature in 25°C ambient; (Efficiency will be about 2.0% lower if measured immediately after startup.)
MTBF	-	380,000 Hours	-	Measured at 220Vac input, 80%Load and 25°C ambient temperature (MIL-HDBK-217F)
Lifetime	-	100,000 Hours	-	Measured at 220Vac input, 80%Load and 70°C case temperature; See lifetime vs. Tc curve for the details
Operating Case Temperature for Safety T _{c_s}	-40°C	-	+88°C	
Operating Case Temperature for Warranty T _{c_w}	-40°C	-	+75°C	Case temperature for 5 years warranty
Storage Temperature	-40°C	-	+85°C	Humidity: 5%RH to 100%RH
Dimensions Inches (L x W x H) Millimeters (L x W x H)	6.34 x 2.66 x 1.44 161 x 67.5 x 36.5			With mounting ear 7.17 x 2.66 x 1.44 182 x 67.5 x 36.5
Net Weight	-	850g	-	

Note: All specifications are typical at 25°C unless otherwise stated.

Dimming Specifications

Parameter		Min.	Typ.	Max.	Notes
DT Models	Absolute Maximum Voltage on the Vdim (+) Pin	-20 V	-	20 V	
	Source Current on Vdim (+)Pin	200 uA	300 uA	450 uA	Vdim(+) = 0 V
	Recommended Dimming Range for 0-10V	0 V	-	10 V	
	PWM_in High Level	-	10V	-	
	PWM_in Low Level	-	0V	-	
	PWM_in Frequency Range	200 Hz	-	2 KHz	
	PWM_in Duty Cycle	0%	-	100%	
TT Models	Dimming Level	10%	-	100%	Default is Traditional Timer. Dimming mode set to Self Adapting-Midnight or Self Adapting-Percentage in PC interface.
	Hold Time	0 Hours	-	18 Hours	
	Fade Time	0 Minutes	-	60 Minutes	
	Dimming Step	1	-	6	
Dimming Output Range	EUK-096S105DT(TT) EUK-096S150DT(TT) EUK-096S210DT(TT) EUK-096S350DT(TT)	10%I _{oSet}	-	I _{oSet}	700mA ≤ I _{oSet} ≤ 1050mA 1050mA ≤ I _{oSet} ≤ 1500mA 1400mA ≤ I _{oSet} ≤ 2100mA 2450mA ≤ I _{oSet} ≤ 3500mA
	EUK-096S105DT(TT) EUK-096S150DT(TT) EUK-096S210DT(TT) EUK-096S350DT(TT)	70 mA 105 mA 140 mA 245 mA	-	I _{oSet}	70mA ≤ I _{oSet} < 700mA 105mA ≤ I _{oSet} < 1050mA 140mA ≤ I _{oSet} < 1400mA 245mA ≤ I _{oSet} < 2450mA

Safety & EMC Compliance

Safety Category	Standard
UL/CUL	UL8750,CAN/CSA-C22.2 No. 250.13
CE	EN 61347-1, EN61347-2-13
KS	KS C 7655
EMI Standards	Notes
EN 55015 ⁽¹⁾	Conducted emission Test & Radiated emission Test
EN 61000-3-2	Harmonic current emissions
EN 61000-3-3	Voltage fluctuations & flicker
FCC Part 15 ⁽¹⁾	ANSI C63.4 Class B
	This device complies with Part 15 of the FCC Rules. Operation is subject to the following two conditions: [1] this device may not cause harmful interference, and [2] this device must accept any interference received, including interference that may cause undesired Operation.

Safety & EMC Compliance (Continued)

EMS Standards	Notes
EN 61000-4-2	Electrostatic Discharge (ESD): 8 kV air discharge, 4 kV contact discharge
EN 61000-4-3	Radio-Frequency Electromagnetic Field Susceptibility Test-RS
EN 61000-4-4	Electrical Fast Transient / Burst-EFT
EN 61000-4-5	Surge Immunity Test: AC Power Line: line to line 6 kV, line to earth 10 kV ⁽²⁾
EN 61000-4-6	Conducted Radio Frequency Disturbances Test-CS
EN 61000-4-8	Power Frequency Magnetic Field Test
EN 61000-4-11	Voltage Dips
EN 61547	Electromagnetic Immunity Requirements Applies To Lighting Equipment

Note: (1) This LED driver meets the EMI specifications above, but EMI performance of a luminaire that contains it depends also on the other devices connected to the driver and on the fixture itself.

(2) To perform electric strength (hi-pot) testing, the “GDT ground disconnect” (nut and metal lock sheet) on the driver end-cap should be removed temporarily to prevent the internal gas discharge tube from conducting (as allowed by IEC 60598-1 Clause 10.2). After testing is completed, these items must be reinstalled to restore line-to-earth surge protection and secure the end cap.

Derating

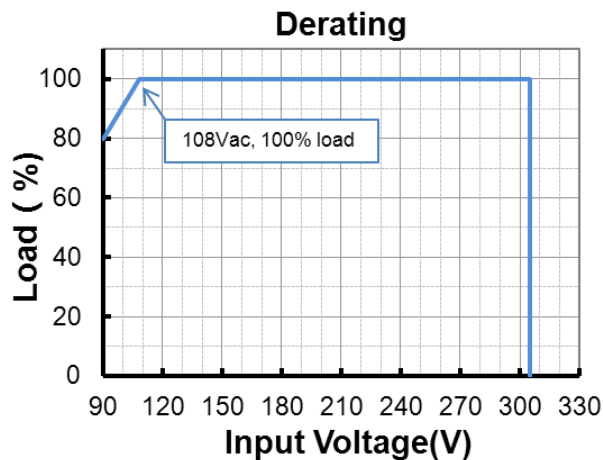

Lifetime vs. Case Temperature

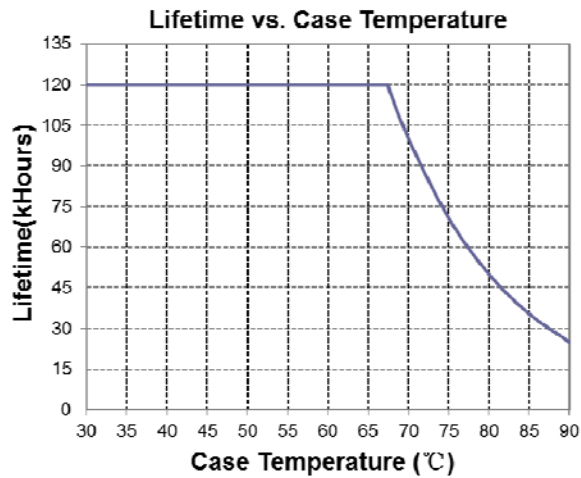

Inrush Current Waveform

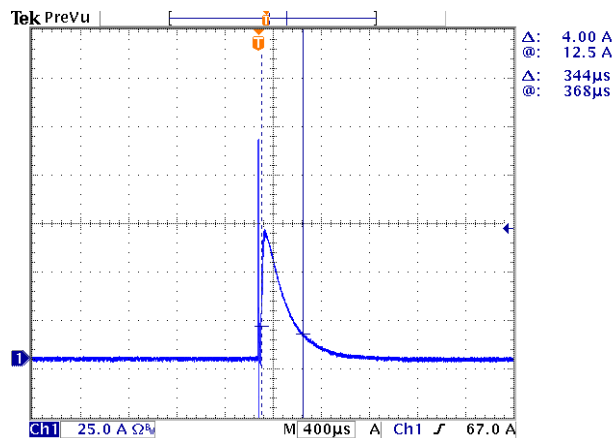

Efficiency vs. Load

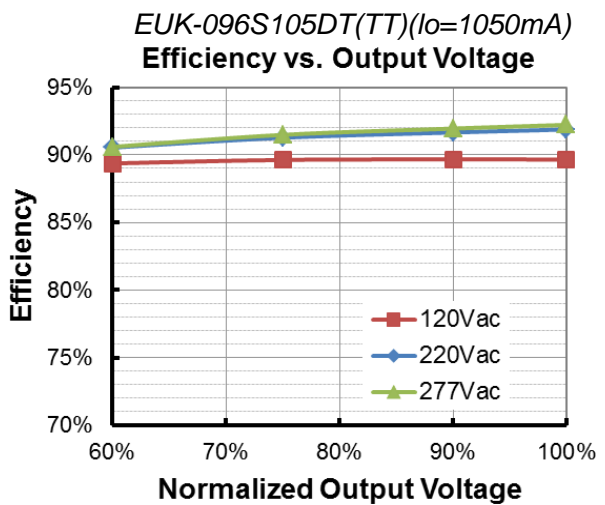
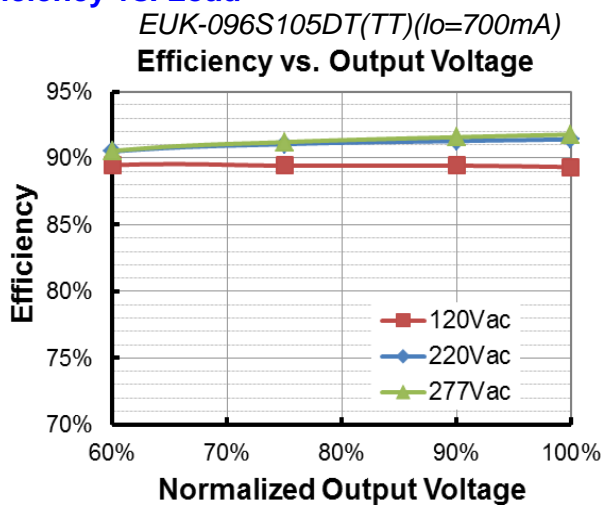

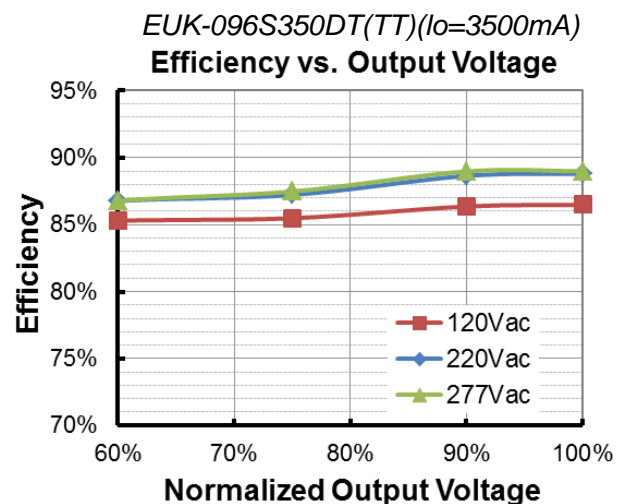
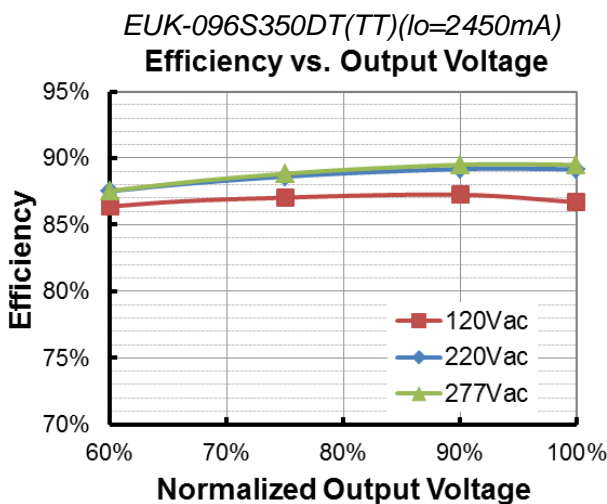
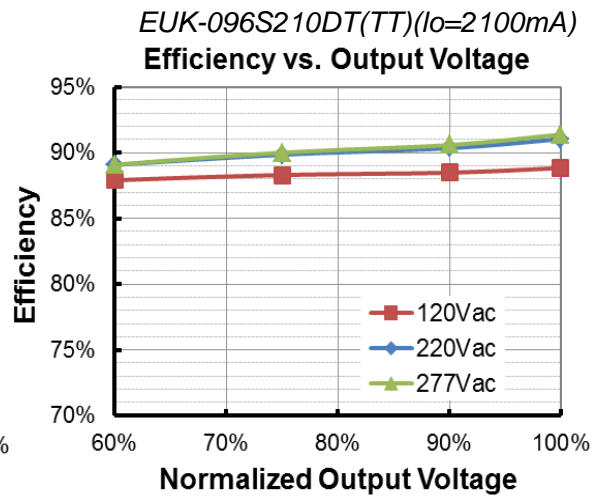
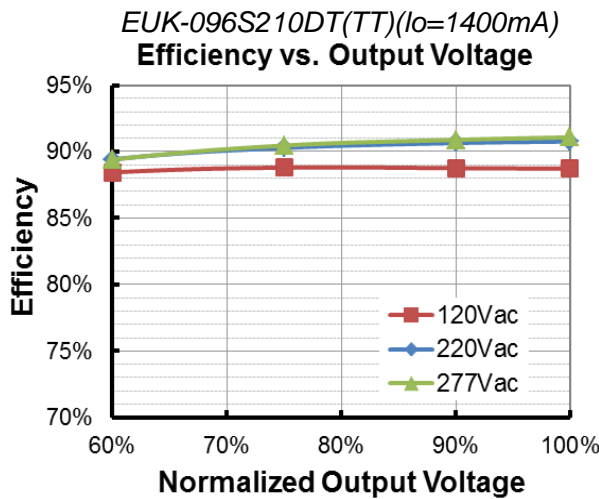
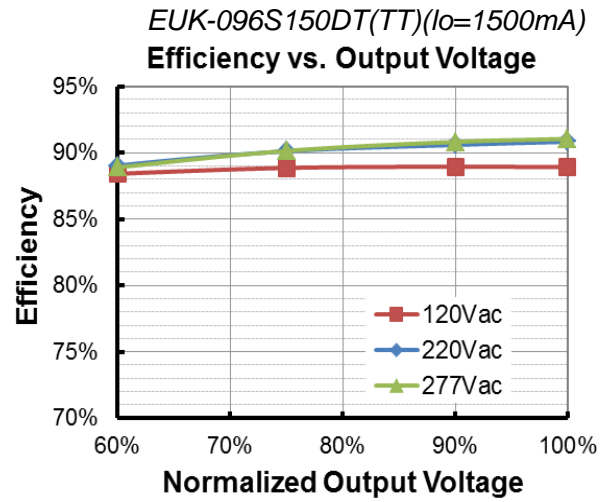
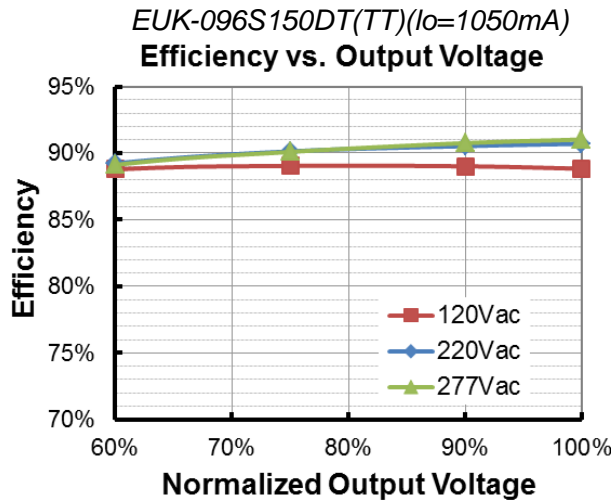

Power Factor

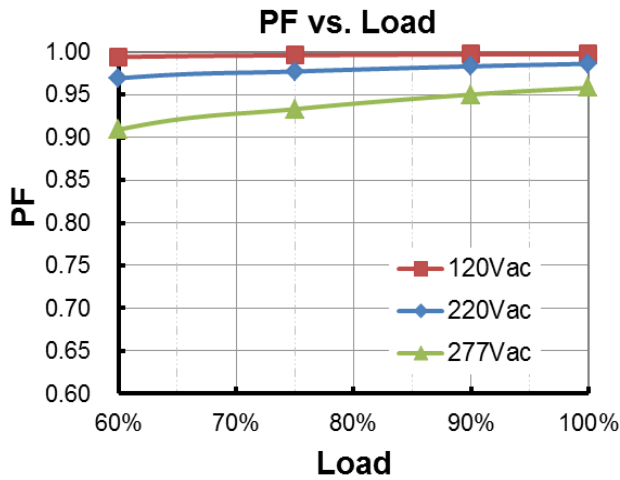

Total Harmonic Distortion

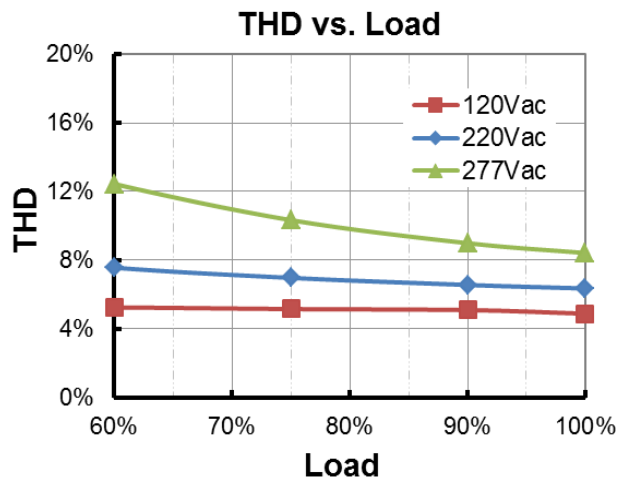

Protection Functions

Parameter	Notes
Over Temperature Protection	Decreases output current, returning to normal after over temperature is removed.
Short Circuit Protection	Auto Recovery. No damage will occur when any output is short circuited. The output shall return to normal when the fault condition is removed.
Over Voltage Protection	Limits output voltage at no load and in case the normal voltage limit fails.

Dimming

● 0-10V Dimming (Only DT models)

The recommended implementation of the dimming control is provided below.

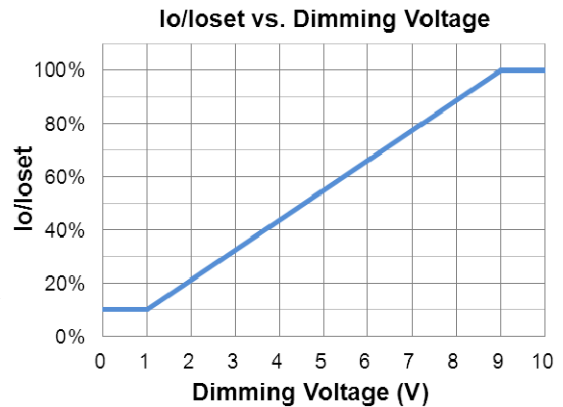
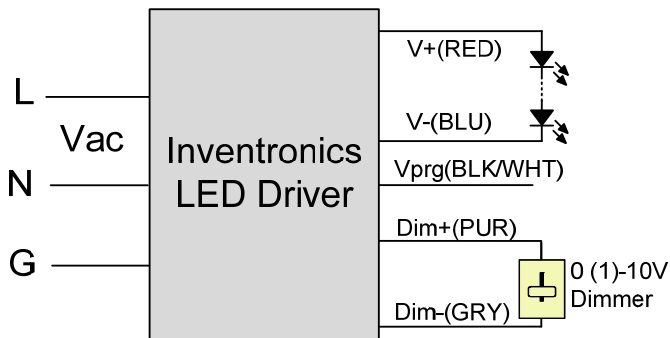

Implementation 1

Notes:

1. The dimmer can also be replaced by an active 0-10V voltage source signal or passive components like resistors and zener.
2. If 0-10V dimming is not used, Dim + should be open.

● 10V PWM Dimming (Only DT models)

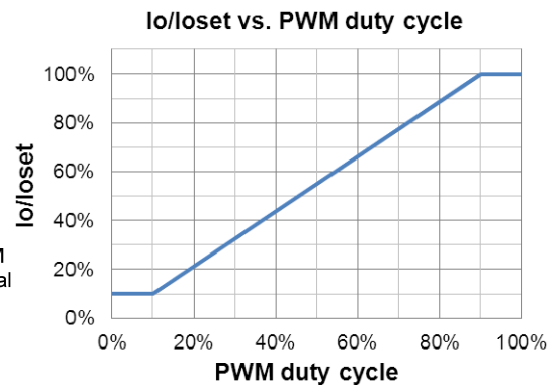
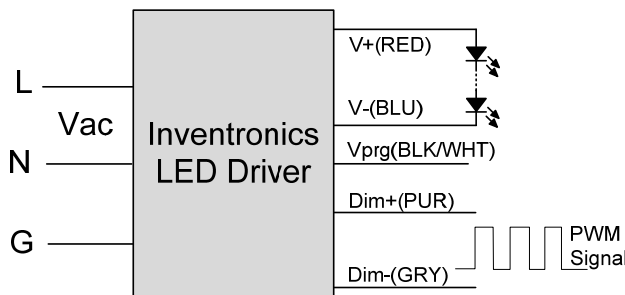

Implementation 2

Notes: If PWM dimming is not used, Dim + should be open.

● **Time Dimming (Only TT models)**

Time dimming control includes 3 kinds of modes, they are Self Adapting-Midnight, Self Adapting-Percentage and Traditional Timer.

- **Self Adapting-Midnight:** Automatically adjusts the dimming curve based on the on-time of past two days (if difference <15 minutes), assuming that the center point of the dimming curve is midnight local time.
- **Self Adapting-Percentage:** Automatically adjusts the on-time of each step by a constant percentage = (actual on-time for the past 2 days if difference <15 min) / (programmed on-time from the dimming curve).
- **Traditional Timer:** Follows the programmed timing curve after power on with no changes.

● **Output Lumen Compensation (Only TT models)**

Output Lumen Compensation (OLC) may be used to maintain constant light output over the life of the LEDs by driving them at a reduced current when new, then gradually increasing the drive current over time to counteract LED lumen degradation.

Programming Connection Diagram

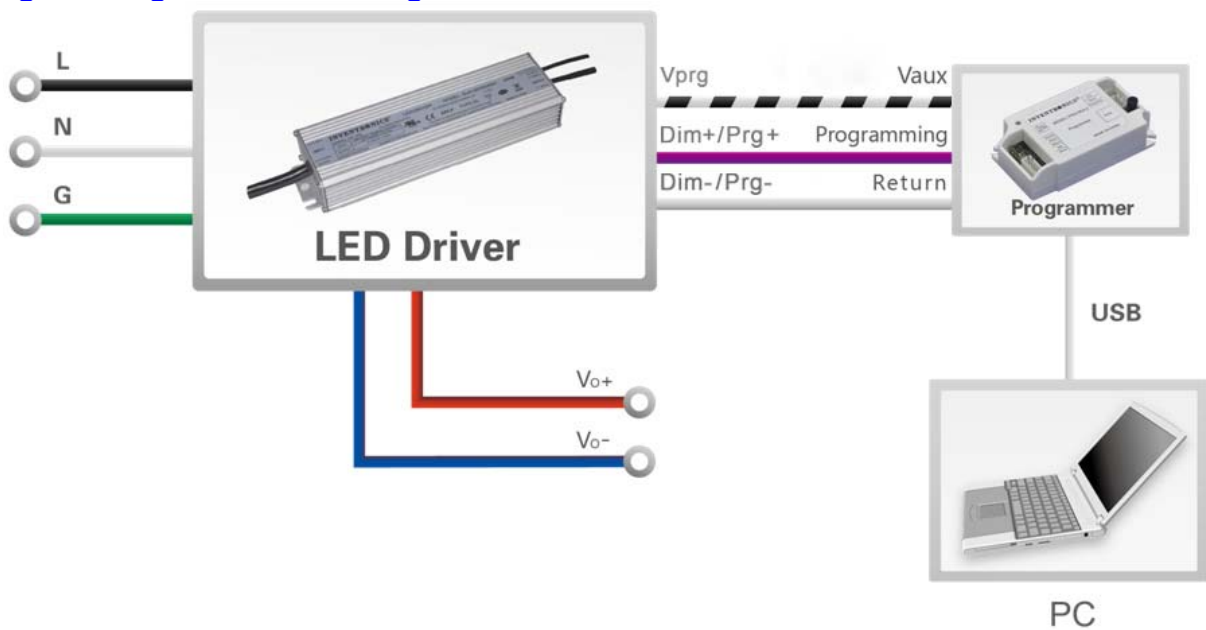

Note: The driver does not need to be powered on during the programming process.

- Please refer to [PRG-MUL2](#) (Programmer) datasheet for details.

Mechanical Outline

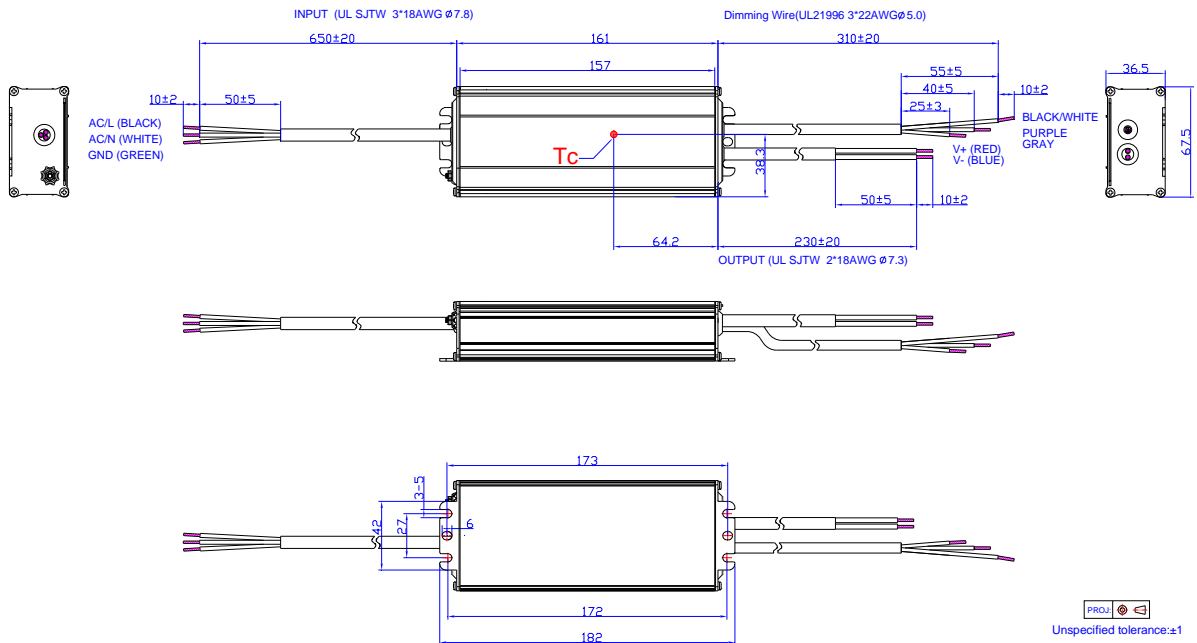

RoHS Compliance

Our products comply with the European Directive 2011/65/EC, calling for the elimination of lead and other hazardous substances from electronic products.

Revision History

Change Date	Rev.	Description of Change		
		Item	From	To
2017-11-01	A	Datasheets Release	/	/
2017-11-10	B	Operating Case Temperature for Safety Tc_s	+90°C	+88°C
2017-11-17	C	Features	3 Timer Modes Dimmable (TT models)	Added
		Models	EUK-096SxxxTT	Added
		I-V Operation Area	EUK-096SxxxTT	Added
		Output Current Setting(losct) Range	EUK-096SxxxTT	Added
		Output Current Setting Range with Constant Power	EUK-096SxxxTT	Added
		No Load Output Voltage	EUK-096SxxxTT	Added
		Efficiency at 120 Vac input	EUK-096SxxxTT	Added
		Efficiency at 220 Vac input	EUK-096SxxxTT	Added
		Efficiency at 277 Vac input	EUK-096SxxxTT	Added
		Dimming Specifications	TT Models	Added
		Efficiency vs. Load	EUK-096SxxxTT	Added
		Dimming	/	Updated
2018-05-28	D	Description	/	Updated
		Mechanical Outline	/	Updated