

Features

- Ultra High Efficiency (Up to 93.5%)
- Full Power at Wide Output Current Range (Constant Power)
- 0-10V/10V PWM Dimmable
- Input Surge Protection: 6kV line-line, 10kV line-earth
- All-Around Protection: OVP, SCP, OTP
- Waterproof (IP67) and UL Dry / Damp / Wet Location
- SELV Output
- TYPE HL, for use in a Class I, Division 2 hazardous (Classified) location
- 5 Years Warranty



Description

The EUK-240SxxxDT series is a 240W, constant-current, programmable IP67 LED driver that operates from 90-305 Vac input with excellent power factor. It is created for high bay, high mast, arena and roadway lights. The high efficiency of these drivers and compact metal case enables them to run cooler, significantly improving reliability and extending product life. To ensure trouble-free operation, protection is provided against input surge, output over voltage, short circuit, and over temperature.

Models

Adjustable Output Current Range	Full-Power Current Range (1)	Default Output Current	Input Voltage Range(2)	Output Voltage Range	Max. Output Power	Typical Efficiency (3)	Power Factor		Model Number
							120Vac	220Vac	
70-1050mA	700-1050mA	700 mA	90~305 Vac/ 127~300 Vdc	114~343Vdc	240W	93.5%	0.99	0.96	EUK-240S105DT
105-1500mA	1050-1500mA	1050 mA	90~305 Vac/ 127~300 Vdc	80~229Vdc	240W	93.5%	0.99	0.96	EUK-240S150DT
140-2100mA	1400-2100mA	1400 mA	90~305 Vac/ 127~300 Vdc	57~171Vdc	240W	93.5%	0.99	0.96	EUK-240S210DT
280-4200mA	2800-4200mA	4200 mA	90~305 Vac/ 127~300 Vdc	29 ~ 86Vdc	240W	92.5%	0.99	0.96	EUK-240S420DT ⁽⁴⁾
460-6700mA	4600-6700mA	6700 mA	90~305 Vac/ 127~300 Vdc	18 ~ 52Vdc	240W	92.0%	0.99	0.96	EUK-240S670DT ⁽⁴⁾

- Notes:** (1) Output current range with constant power at 240W
 (2) UL, FCC certified input voltage range: 100-277Vac or 127-300Vdc; other certified input voltage range except UL & FCC: 100-240Vac or 127-250Vdc (except KS)
 (3) Measured at full load and 220Vac input (see below "General Specifications" for details).
 (4) SELV Output.

I-V Operating Area

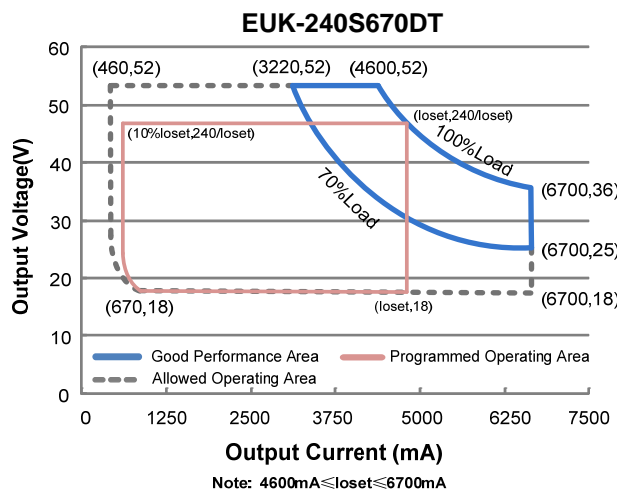
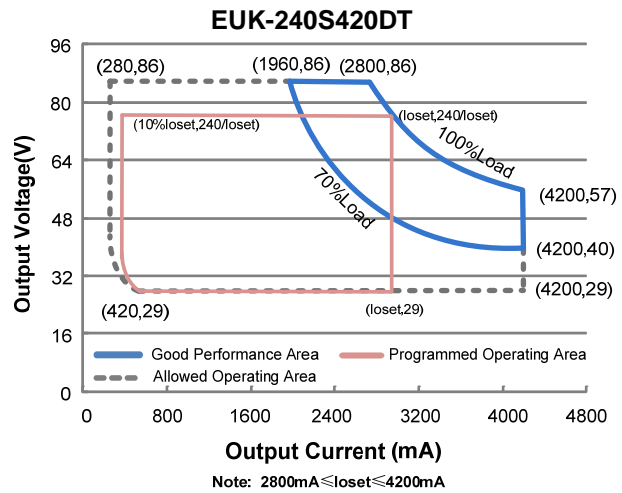
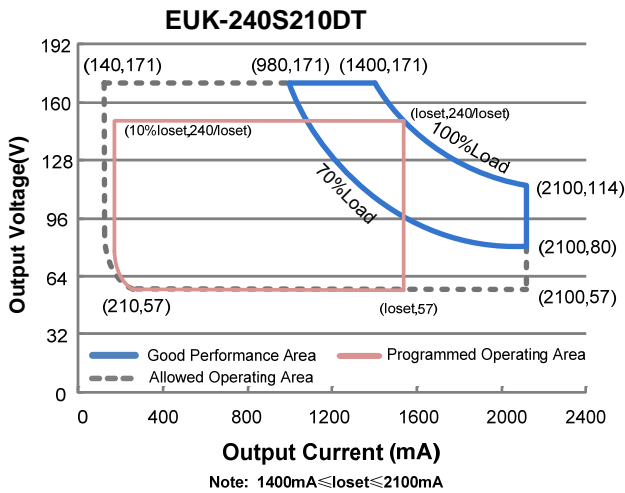
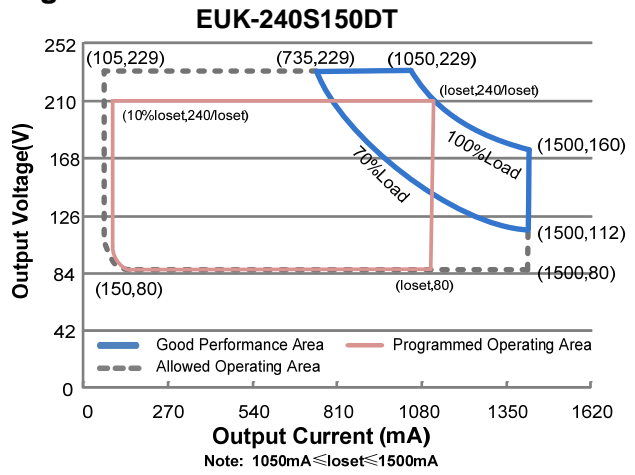
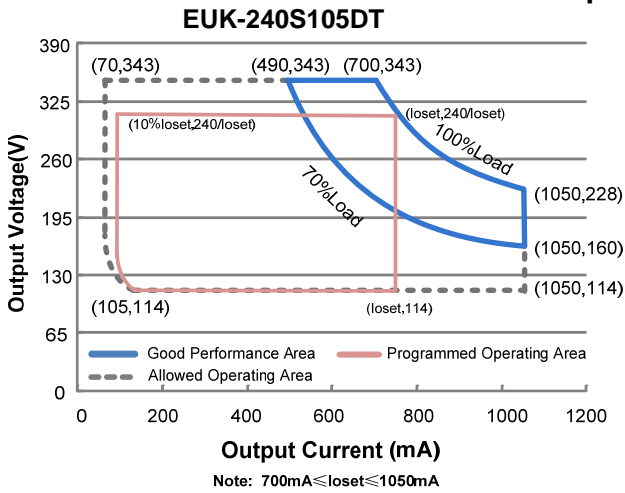

Input Specifications

Parameter	Min.	Typ.	Max.	Notes
Input Voltage	90 Vac	-	305 Vac	127~300 Vdc
Input Frequency	47 Hz	-	63 Hz	
Leakage Current	-	-	0.75 MIU	UL8750; 277Vac/ 60Hz
	-	-	0.70 mA	IEC60598-1; 240Vac/ 60Hz
Input AC Current	-	-	2.5A	Measured at full load and 120 Vac input.
	-	-	1.3 A	Measured at full load and 220 Vac input.
Inrush Current(I ² t)	-	-	0.90 A ² s	At 220Vac input, 25°C cold start, duration=592μs, 10%Ipk-10%Ipk. See Inrush Current Waveform for the details.
PF	0.9	-	-	At 100-277Vac, 50-60Hz, 70%-100% Load (168-240W)
THD	-	-	20%	
THD	-	-	10%	At 220-240Vac, 50-60Hz, 75%-100% Load (180-240W)

Output Specifications

Parameter	Min.	Typ.	Max.	Notes
Output Current Tolerance	-5%loset	-	5%loset	At full load condition
Output Current Setting(loset) Range				
EUK-240S105DT	70 mA	-	1050 mA	
EUK-240S150DT	105 mA	-	1500 mA	
EUK-240S210DT	140 mA	-	2100 mA	
EUK-240S420DT	280 mA	-	4200 mA	
EUK-240S670DT	460 mA	-	6700 mA	
Output Current Setting Range with Constant Power				
EUK-240S105DT	700 mA	-	1050 mA	
EUK-240S150DT	1050 mA	-	1500 mA	
EUK-240S210DT	1400 mA	-	2100 mA	
EUK-240S420DT	2800 mA	-	4200 mA	
EUK-240S670DT	4600 mA	-	6700 mA	
Total Output Current Ripple (pk-pk)	-	5%lomax	10%lomax	At full load condition. 20 MHz BW
Output Current Ripple at < 200 Hz (pk-pk)	-	2%lomax	-	At full load condition. Only this component of ripple is associated with visible flicker.
Startup Overshoot Current	-	-	10%lomax	At full load condition
No Load Output Voltage				
EUK-240S105DT	-	-	390 V	
EUK-240S150DT	-	-	270V	
EUK-240S210DT	-	-	200 V	
EUK-240S420DT	-	-	110 V	
EUK-240S670DT	-	-	70 V	

Output Specifications (Continued)

Parameter	Min.	Typ.	Max.	Notes
Line Regulation	-	-	±0.5%	Measured at full load
Load Regulation	-	-	±1.5%	
Turn-on Delay Time	-	-	1.0 s	Measured at 120Vac input, 70%-100% Load
	-	-	0.5 s	Measured at 220Vac input, 70%-100% Load
Temperature Coefficient of I _o set	-	0.03%/°C	-	Case temperature = 0°C ~T _c max

Note: All specifications are typical at 25°C unless otherwise stated.

General Specifications

Parameter	Min.	Typ.	Max.	Notes
Efficiency at 120 Vac input:				Measured at full load and steady-state temperature in 25°C ambient; (Efficiency will be about 2.0% lower if measured immediately after startup.)
EUK-240S105DT				
I _o = 700 mA	88.5%	90.5%	-	
I _o =1050 mA	87.5%	89.5%	-	
EUK-240S150DT				
I _o =1050 mA	88.5%	90.5%	-	
I _o =1500 mA	87.5%	89.5%	-	
EUK-240S210DT				
I _o =1400 mA	88.5%	90.5%	-	
I _o =2100 mA	87.0%	89.0%	-	
EUK-240S420DT				
I _o =2800 mA	87.5%	89.5%	-	
I _o =4200 mA	85.5%	87.5%	-	
EUK-240S670DT				
I _o =4600 mA	87.0%	89.0%	-	
I _o =6700 mA	85.0%	87.0%	-	
Efficiency at 220 Vac input:				Measured at full load and steady-state temperature in 25°C ambient; (Efficiency will be about 2.0% lower if measured immediately after startup.)
EUK-240S105DT				
I _o = 700 mA	91.5%	93.5%	-	
I _o =1050 mA	90.0%	92.0%	-	
EUK-240S150DT				
I _o =1050 mA	91.5%	93.5%	-	
I _o =1500 mA	90.0%	92.0%	-	
EUK-240S210DT				
I _o =1400 mA	91.5%	93.5%	-	
I _o =2100 mA	90.0%	92.0%	-	
EUK-240S420DT				
I _o =2800 mA	90.5%	92.5%	-	
I _o =4200 mA	88.5%	90.5%	-	
EUK-240S670DT				
I _o =4600 mA	90.0%	92.0%	-	
I _o =6700 mA	88.0%	90.0%	-	

General Specifications (Continued)

Parameter	Min.	Typ.	Max.	Notes
Efficiency at 277 Vac input: EUK-240S105DT I _o = 700 mA I _o =1050 mA EUK-240S150DT I _o =1050 mA I _o =1500 mA EUK-240S210DT I _o =1400 mA I _o =2100 mA EUK-240S420DT I _o =2800 mA I _o =4200 mA EUK-240S670DT I _o =4600 mA I _o =6700 mA	92.0% 90.5% 92.0% 90.5% 92.0% 90.5% 91.0% 89.0% 90.5% 88.5%	94.0% 92.5% 94.0% 92.5% 94.0% 92.5% 93.0% 91.0% 92.5% 90.5%	- - - - - - - - - -	Measured at full load and steady-state temperature in 25°C ambient; (Efficiency will be about 2.0% lower if measured immediately after startup.)
MTBF	-	241,000 Hours	-	Measured at 220Vac input, 80%Load and 25°C ambient temperature (MIL-HDBK-217F)
Lifetime	-	84,000 Hours	-	Measured at 220Vac input, 80%Load and 70°C case temperature; See lifetime vs. T _c curve for the details
Operating Case Temperature for Safety T _{c_s}	-40°C	-	+88°C	
Operating Case Temperature for Warranty T _{c_w}	-40°C	-	+75°C	Case temperature for 5 years warranty
Storage Temperature	-40°C	-	+85°C	Humidity: 5%RH to 100%RH
Dimensions Inches (L × W × H) Millimeters (L × W × H)		8.35 × 2.66 × 1.56 212 × 67.5 × 39.7		With mounting ear 9.17 × 2.66 × 1.56 233 × 67.5 × 39.7
Net Weight	-	1200 g	-	

Note: All specifications are typical at 25°C unless otherwise stated.

Dimming Specifications

Parameter	Min.	Typ.	Max.	Notes	
DT Models	Absolute Maximum Voltage on the V _{dim} (+) Pin	-20 V	-	20 V	
	Source Current on V _{dim} (+)Pin	200 uA	300 uA	450 uA	V _{dim} (+) = 0 V
	Recommended Dimming Range for 0-10V	0 V	-	10 V	
	PWM _{in} High Level	-	10V	-	
	PWM _{in} Low Level	-	0V	-	
	PWM _{in} Frequency Range	200 Hz	-	2 KHz	
	PWM _{in} Duty Cycle	0%	-	100%	

Dimming Specifications

Parameter		Min.	Typ.	Max.	Notes
Dimming Output Range	EUK-240S105DT EUK-240S150DT EUK-240S210DT EUK-240S420DT EUK-240S670DT	10%loset	-	loset	700 mA ≤ loset ≤ 1050 mA 1050 mA ≤ loset ≤ 1500 mA 1400 mA ≤ loset ≤ 2100 mA 2800 mA ≤ loset ≤ 4200 mA 4600 mA ≤ loset ≤ 6700 mA
	EUK-240S105DT EUK-240S150DT EUK-240S210DT EUK-240S420DT EUK-240S670DT	70 mA 105 mA 140 mA 280 mA 460 mA	-	loset	70 mA ≤ loset < 700 mA 105 mA ≤ loset < 1050 mA 140 mA ≤ loset < 1400 mA 280 mA ≤ loset < 2800 mA 460 mA ≤ loset < 4600 mA

Safety & EMC Compliance

Safety Category	Standard
UL/CUL	UL8750,CAN/CSA-C22.2 No. 250.13
CE	EN 61347-1, EN61347-2-13
KS	KS C 7655
EMI Standards	Notes
EN 55015 ⁽¹⁾	Conducted emission Test & Radiated emission Test
EN 61000-3-2	Harmonic current emissions
EN 61000-3-3	Voltage fluctuations & flicker
FCC Part 15 ⁽¹⁾	ANSI C63.4 Class B
	This device complies with Part 15 of the FCC Rules. Operation is subject to the following two conditions: [1] this device may not cause harmful interference, and [2] this device must accept any interference received, including interference that may cause undesired Operation.
EMS Standards	Notes
EN 61000-4-2	Electrostatic Discharge (ESD): 8 kV air discharge, 4 kV contact discharge
EN 61000-4-3	Radio-Frequency Electromagnetic Field Susceptibility Test-RS
EN 61000-4-4	Electrical Fast Transient / Burst-EFT
EN 61000-4-5	Surge Immunity Test: AC Power Line: line to line 6 kV, line to earth 10 kV ⁽²⁾
EN 61000-4-6	Conducted Radio Frequency Disturbances Test-CS
EN 61000-4-8	Power Frequency Magnetic Field Test
EN 61000-4-11	Voltage Dips
EN 61547	Electromagnetic Immunity Requirements Applies To Lighting Equipment

Note: (1) This LED driver meets the EMI specifications above, but EMI performance of a luminaire that contains it depends also on the other devices connected to the driver and on the fixture itself.

(2) To perform electric strength (hi-pot) testing, the “GDT ground disconnect” (nut and metal lock sheet) on the driver end-cap should be removed temporarily to prevent the internal gas discharge tube from conducting (as allowed by IEC 60598-1 Clause 10.2). After testing is completed, these items must be reinstalled to restore line-to-earth surge protection and secure the end cap.

Derating

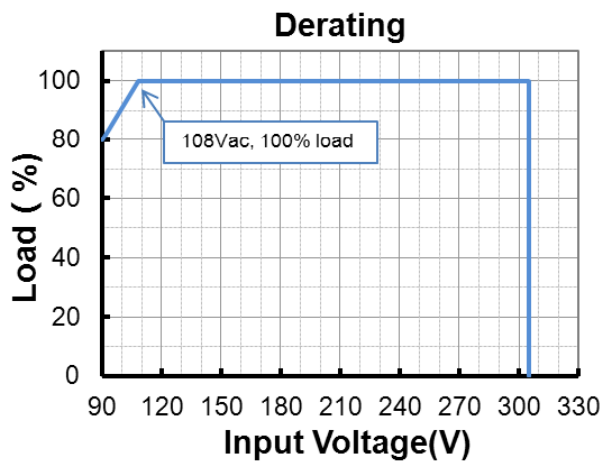

Lifetime vs. Case Temperature

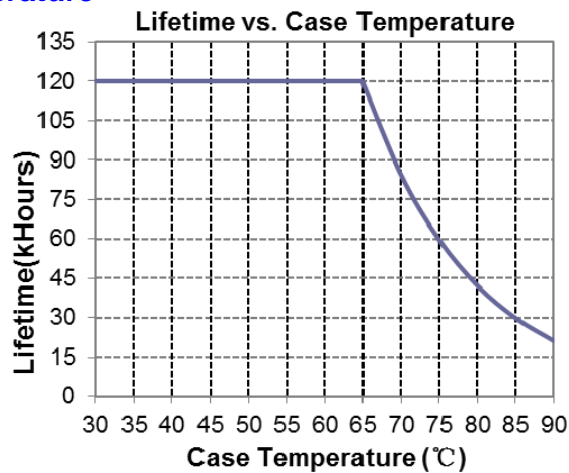

Inrush Current Waveform

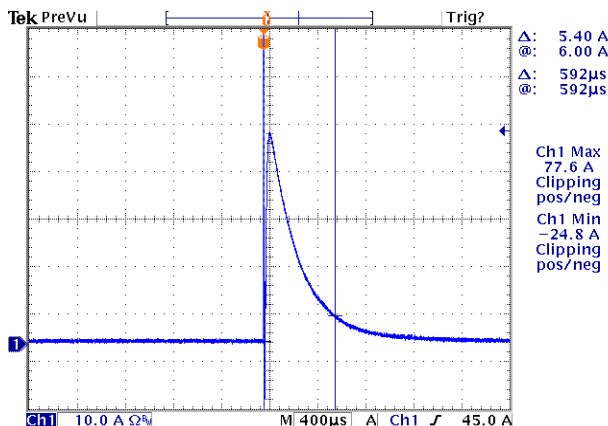

Efficiency vs. Load

EUK-240S105DT (I_o=700mA)
Efficiency vs. Output Voltage

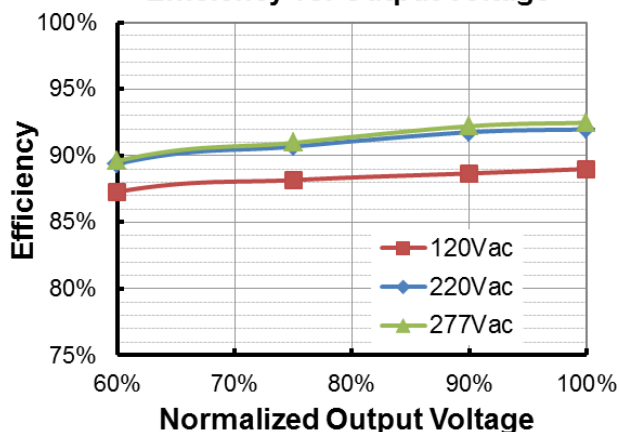

EUK-240S105DT (I_o=1050mA)
Efficiency vs. Output Voltage

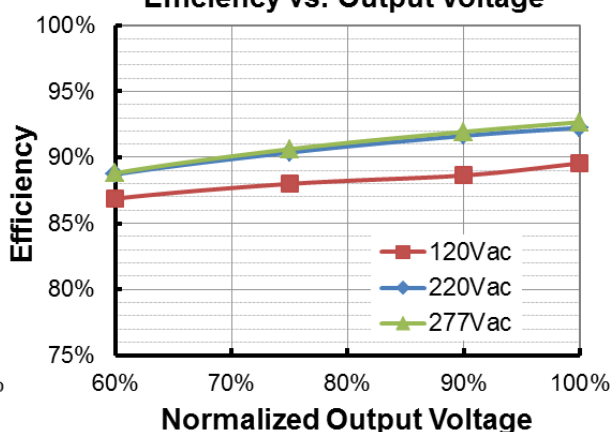

EUK-240S150DT (I_o=1050mA)
Efficiency vs. Output Voltage

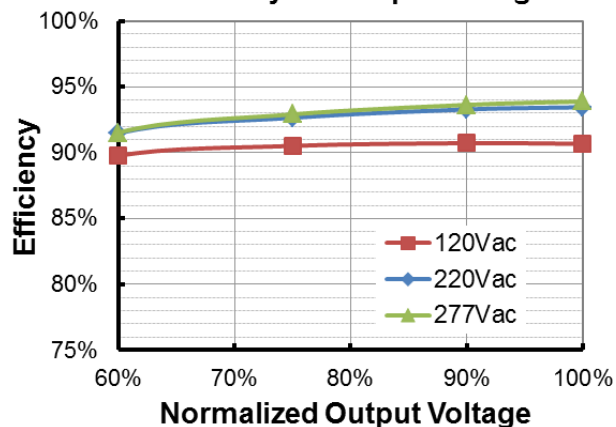

EUK-240S150DT (I_o=1500mA)
Efficiency vs. Output Voltage

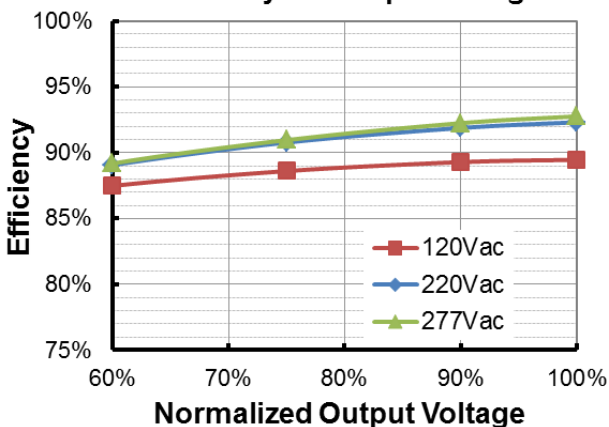

EUK-240S210DT (Io=1400mA)
Efficiency vs. Output Voltage

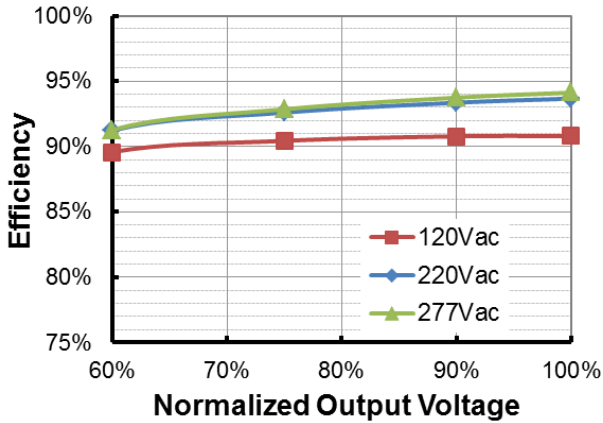

EUK-240S210DT (Io=2100mA)
Efficiency vs. Output Voltage

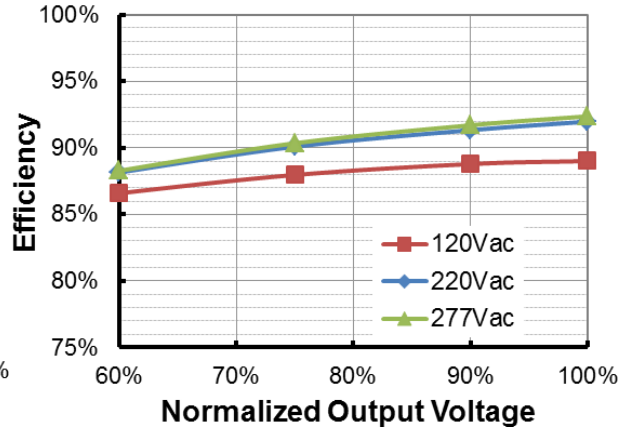

EUK-240S420DT (Io=2800mA)
Efficiency vs. Output Voltage

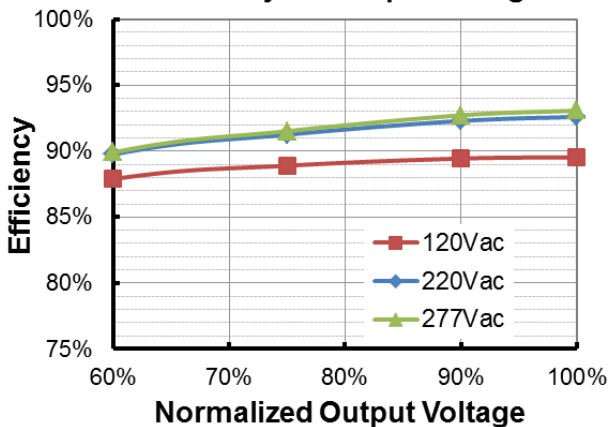

EUK-240S420DT (Io=4200mA)
Efficiency vs. Output Voltage

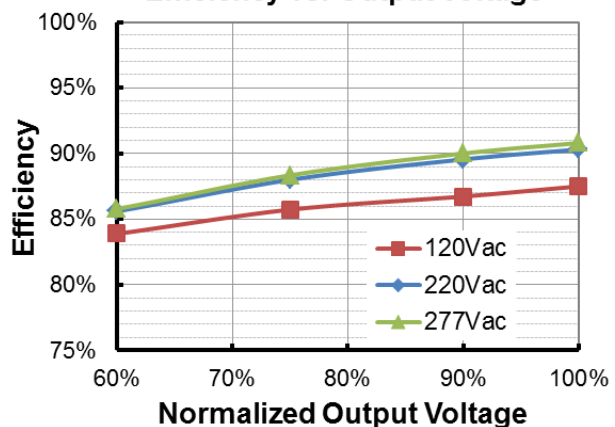

EUK-240S670DT (Io=4600mA)
Efficiency vs. Output Voltage

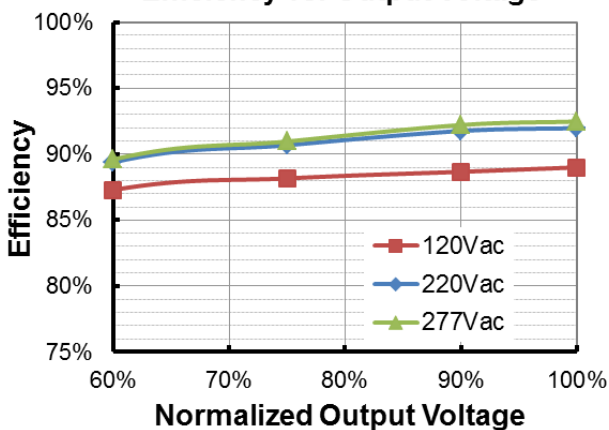

EUK-240S670DT (Io=6700mA)
Efficiency vs. Output Voltage

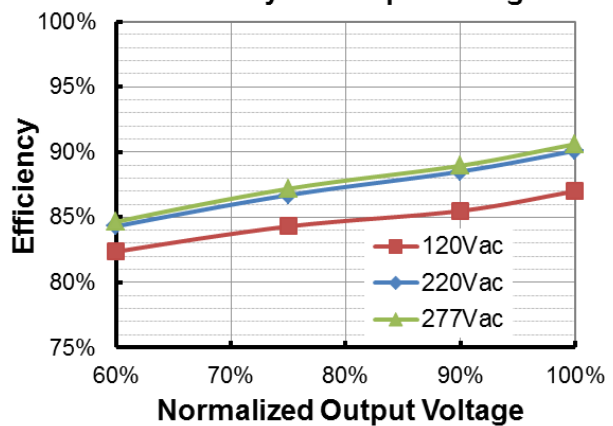

Power Factor

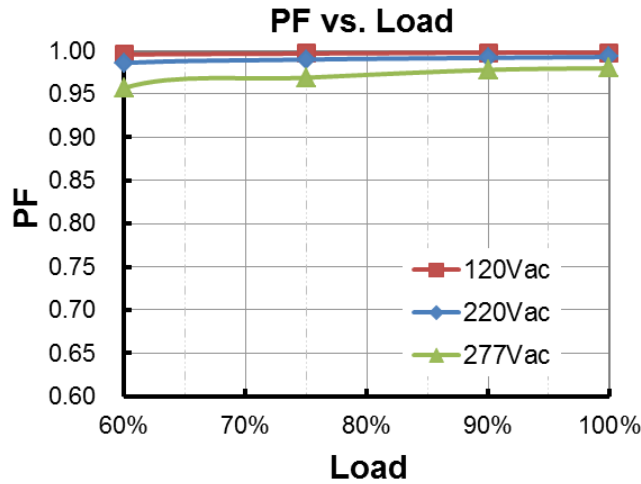

Total Harmonic Distortion

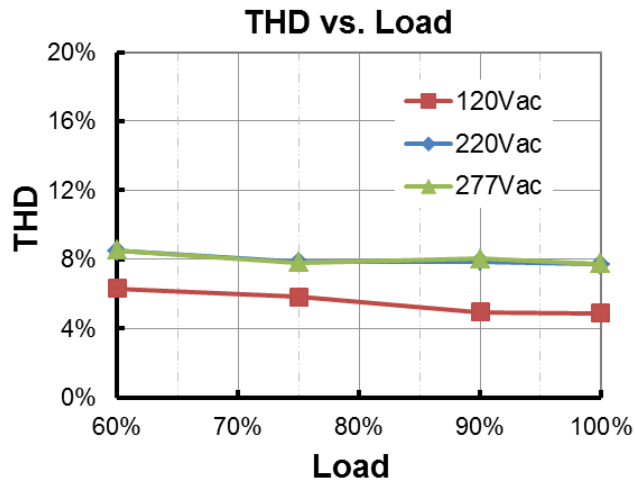

Protection Functions

Parameter	Notes
Over Temperature Protection	Decreases output current, returning to normal after over temperature is removed.
Short Circuit Protection	Auto Recovery. No damage will occur when any output is short circuited. The output shall return to normal when the fault condition is removed.
Over Voltage Protection	Limits output voltage at no load and in case the normal voltage limit fails.

Dimming

● 0-10V Dimming

The recommended implementation of the dimming control is provided below.

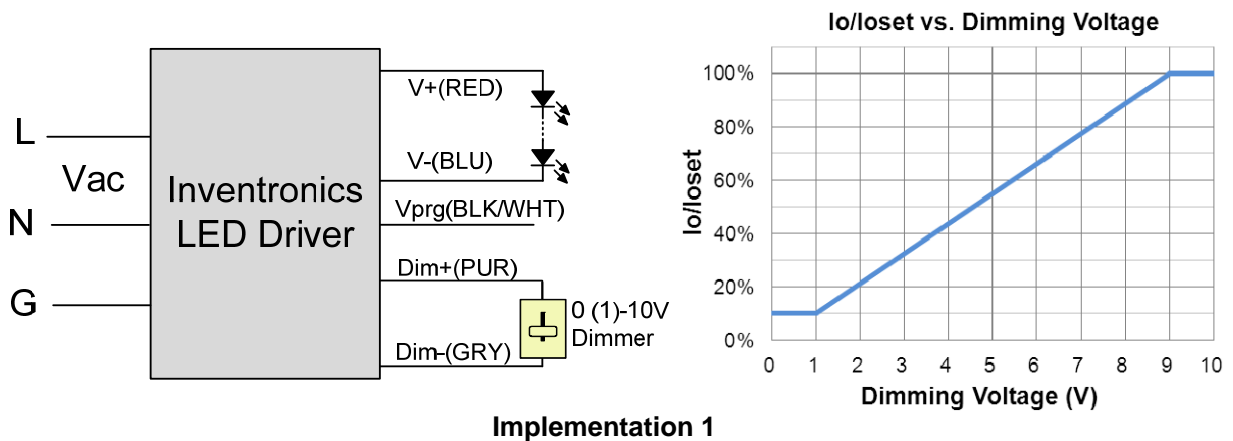

Notes:

1. The dimmer can also be replaced by an active 0-10V voltage source signal or passive components like resistors and zener.
2. If 0-10V dimming is not used, Dim + should be open.

● 10V PWM Dimming

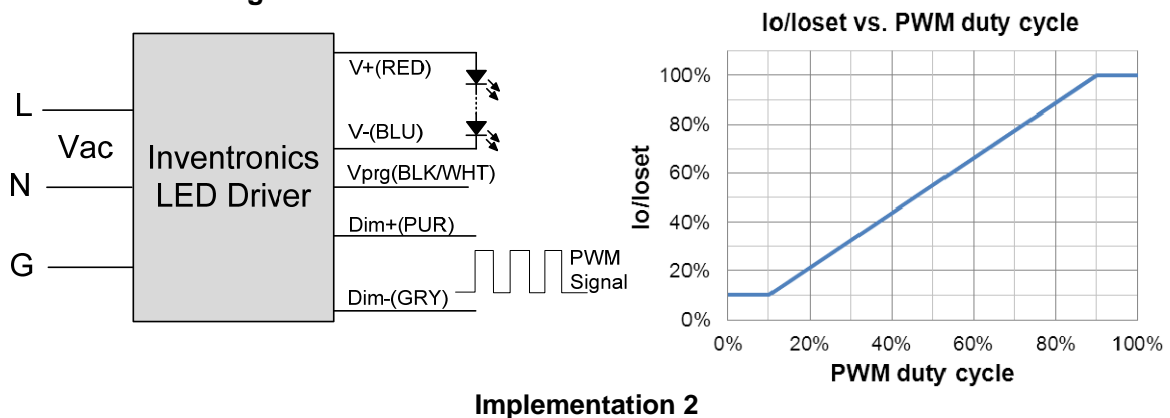

Notes:

1. If PWM dimming is not used, Dim + should be open.

Programming Connection Diagram

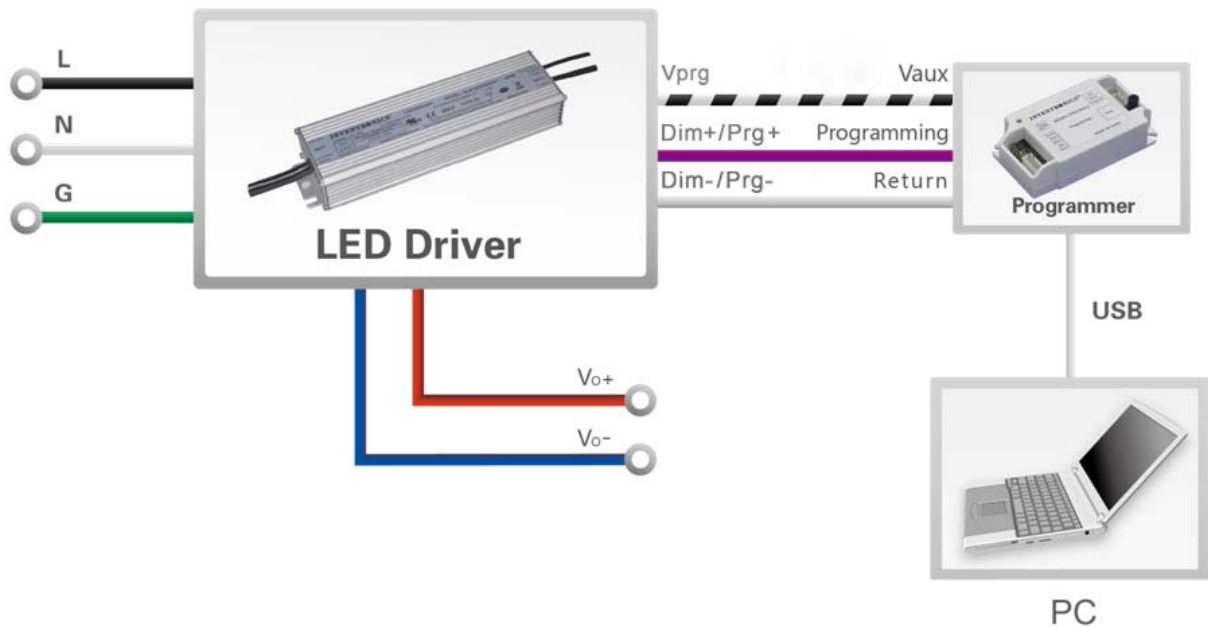

Note: The driver does not need to be powered on during the programming process.

- Please refer to [PRG-MUL2](#) Multi-Programmer datasheet for details.

Mechanical Outline

EUK-240S105DT

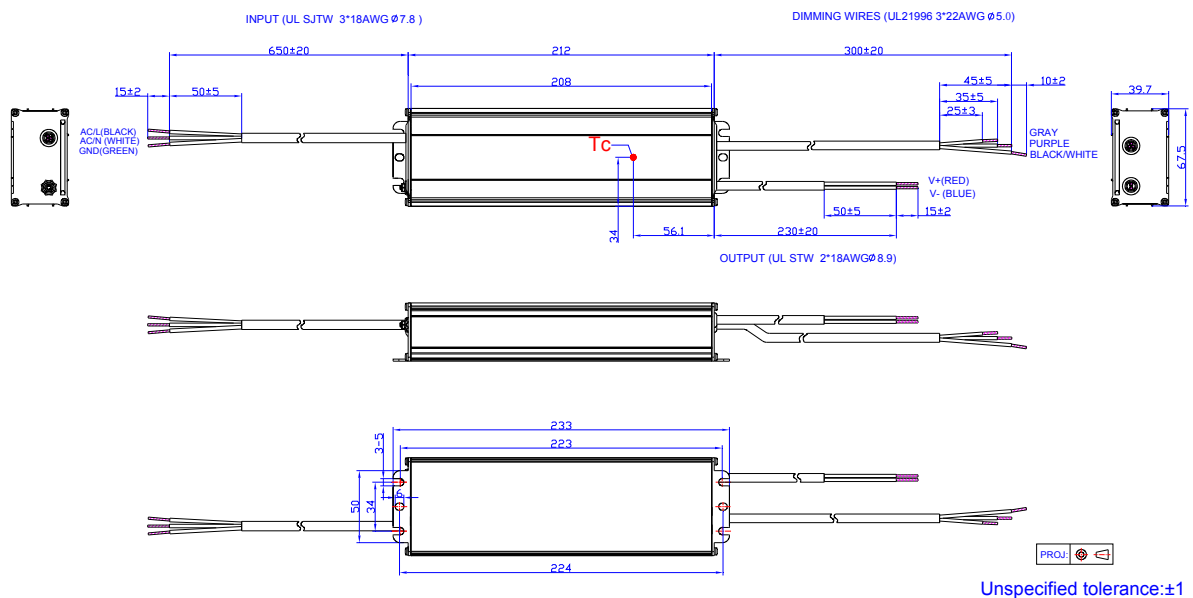

Others

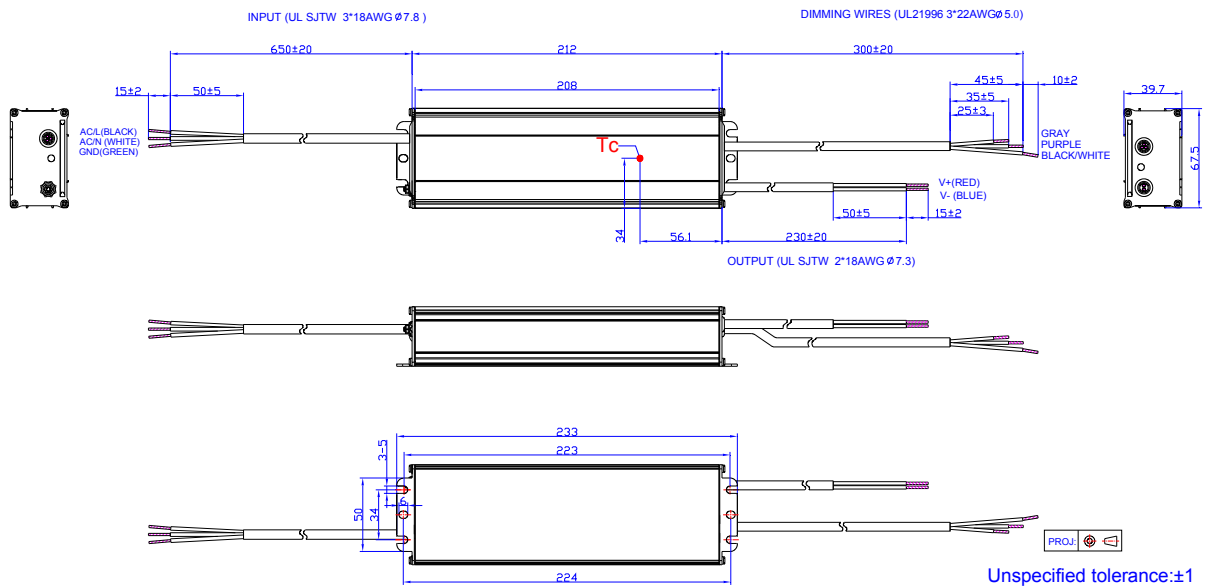

RoHS Compliance

Our products comply with the European Directive 2011/65/EC, calling for the elimination of lead and other hazardous substances from electronic products.

Revision History

Change Date	Rev.	Description of Change		
		Item	From	To
2017-09-12	A	Datasheets Release	/	/
2017-11-10	B	Operating Case Temperature for Safety Tc_s	+90°C	+88°C