

Features

- Dim-to-Off with Standby Power ≤ 0.5 W
- Always-On Auxiliary Power: 12 Vdc, 200 mA
- Thermal Sensing and Protection for LED Module
- Full Power at 70-100% Max Current (Constant Power)
- Flicker-Free
- DALI Dimming Control and Push Dimming Function
- Low Dimming Level to 5%
- Class II, SELV
- Suitable for Built-in Use



Description

The LBD-075SxxxBSF series is a 75W, constant-current, programmable IP20 LED driver with DALI that operates from 176-305Vac input with excellent power factor. It is created for many lighting applications including panel and linear, etc, it provides good dimming accuracy down to 5% output, plus a dim-to-off mode with low standby power. The high efficiency of these drivers and slim metal case enable them to run cooler, significantly improving reliability and extending product life. To ensure trouble-free operation, protection is provided against output over voltage, short circuit, and over temperature of both the driver and the external LED array.

Models

Output Current Range	Full-Power Current Range(1)	Default Output Current	Input Voltage Range(2)	Output Voltage Range	Max. Output Power	Typical Efficiency (3)	Power Factor (3)	Model Number(4)
35-1000mA	700-1000mA	700mA	176~305 Vac	21~107 Vdc	75 W	91.00%	0.96	LBD-075S100BSF
52.5-1500mA	1050-1500mA	1400mA	176~305 Vac	14~71 Vdc	75 W	90.00%	0.96	LBD-075S150BSF
73.5-2100mA	1470-2100mA	2100mA	176~305 Vac	10~51 Vdc	75 W	89.50%	0.96	LBD-075S210BSF

- Notes:** (1) Output current range with constant power at 75W.
 (2) Certified input voltage range: 200-240Vac.
 (3) Measured at a 220Vac input with 70% maximum output current and 100% maximum output voltage.
 (4) SELV output.

I-V Operating Curve

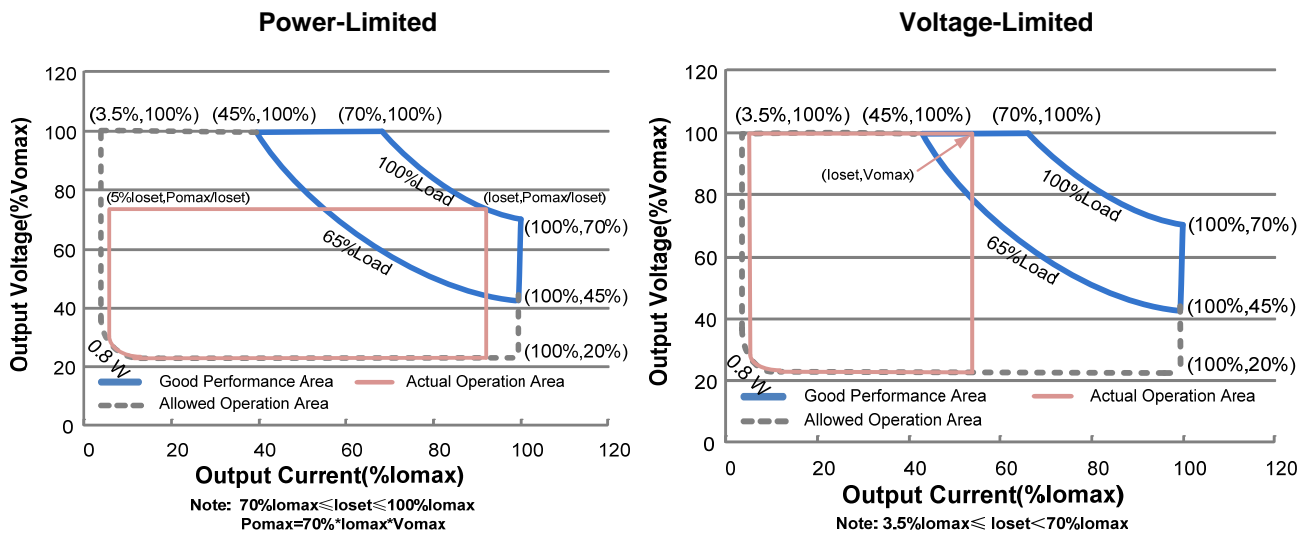

Input Specifications

Parameter	Min.	Typ.	Max.	Notes
Input Voltage	176 V	-	305 V	
Input Frequency	47 Hz	-	63 Hz	
Leakage Current	-	-	0.70 mA	IEC60598-1; 240Vac/ 60Hz
Input AC Current	-	-	0.50 A	Measured at 100% load and 220 Vac input.
Inrush Current(I ² t)	-	-	1.12 A ² s	At 220Vac input, 25°C Cold Start, Duration =528μs, 10%Ipk-10%Ipk. See Inrush Current Waveform for the details.
PF	0.90	-	-	At 220-277Vac, 65%-100%load(48.8-75W)
THD	-	-	20%	
THD	-	-	10%	At 220-240Vac, 50-60Hz, 65%-100%load (48.8-75W)

Output Specifications

Parameter	Min.	Typ.	Max.	Notes
Output Current Tolerance	-5%I _{oset}	-	5%I _{oset}	At 100% load condition
Output Current Setting(I _{oset}) Range	7%I _{omax}	-	100%I _{omax}	
Output Current Setting Range with Constant Power	70%I _{omax}	-	100%I _{omax}	
Total Output Current Ripple (pk-pk)	-	-	10%I _{omax}	At 100% load condition, 20 MHz BW
Output Current Ripple at < 200 Hz (pk-pk)	-	-	5%I _{omax}	At 100% load condition. Only this component of ripple is associated with visible flicker.
Startup Overshoot Current	-	-	10%I _{omax}	At 100% load condition

Output Specifications (Continued)

Parameter	Min.	Typ.	Max.	Notes
No Load Output Voltage LBD-075S100BSF LBD-075S150BSF LBD-075S210BSF	- - -	- - -	120 V 80 V 60 V	
Line Regulation	-	-	±0.5%	Measured at 100% load
Load Regulation	-	-	±1.5%	
Turn-on Delay Time	-	0.3 s	0.5 s	Measured at 220Vac input, 65%-100%load
Temperature Coefficient of Isolet	-	0.02%/°C	-	Case temperature = 0°C ~Tc max
12V Auxiliary Output Voltage	10.8 V	12 V	13.2 V	
12V Auxiliary Output Source Current	0 mA	-	200 mA	Return terminal is "Return– "

Note: All specifications are typical at 25°C unless otherwise stated.

General Specifications

Parameter	Min.	Typ.	Max.	Notes
Efficiency at 220 Vac input: LBD-075S100BSF LBD-075S150BSF LBD-075S210BSF	 io=700 mA 89.0% io=1000 mA 88.5% io=1050 mA 88.0% io=1500 mA 87.5% io=1470 mA 87.5% io=2100 mA 87.0%	 91.00% 90.50% 90.00% 89.50% 89.50% 89.00%	 - - - - - -	 Measured at 100% load and steady-state temperature in 25°C ambient; (Efficiency will be about 2.0% lower if measured immediately after startup.)
Standby Power	-	-	0.5 W	Measured at 230Vac/50Hz; Dimming off
MTBF	-	203,000 Hours	-	Measured at 220Vac input, 80%Load and 25°C ambient temperature (MIL-HDBK-217F)
Lifetime	-	89,000 Hours	-	Measured at 220Vac input, 80%Load and 70°C case temperature; See lifetime vs. Tc curve for the details
Operating Case Temperature for Safety Tc_s	-30 °C	-	+87 °C	
Operating Case Temperature for Warranty Tc_w	-30 °C	-	+75 °C	Humidity: 10% RH to 90% RH; No Condensation.
Storage Temperature	-30 °C	-	+85 °C	Humidity: 5% RH to 90% RH.
Dimensions Inches (L × W × H) Millimeters (L × W ×H)	14.88 × 1.18 × 0.83 378 × 30 × 21			
Net Weight	-	360 g	-	

Note: All specifications are typical at 25°C unless otherwise stated.

Dimming Specifications

Parameter	Min.	Typ.	Max.	Notes
DA1,DA2 High Level	9.5V	16V	22.5V	
DA1,DA2 Low Level	-6.5V	0V	6.5V	
DA1,DA2 Current	0mA	-	2mA	
Dimming Output Range	5%loset	-	loset	70%Iomax ≤ Ioset ≤ 100%Iomax
	3.5%Iomax	-	loset	3.5%Iomax ≤ Ioset < 70%Iomax

Note: All specifications are typical at 25 °C unless stated otherwise.

Standards Compliance

Safety Category	Standard
ENEC & TUV & CE	EN 61347-1 ⁽¹⁾ , EN61347-2-13
CB	IEC 61347-1, IEC 61347-2-13
KS	KS C 7655
EMI Standards	Notes
EN 55015 ⁽²⁾	Conducted emission Test & Radiated emission Test
EN 61000-3-2	Harmonic current emissions
EN 61000-3-3	Voltage Fluctuations & Flicker
EMS Standards	Notes
EN 61000-4-2	Electrostatic Discharge(ESD): 8 kV air discharge, 4 kV contact discharge
EN 61000-4-3	Radio-Frequency Electromagnetic Field Susceptibility Test-RS
EN 61000-4-4	Electrical Fast Transient/Burst-EFT
EN 61000-4-5	Surge Immunity Test: AC Power Line: Differential Mode 1 kV
EN 61000-4-6	Conducted Radio Frequency Disturbances Test-CS
EN 61000-4-8	Power Frequency Magnetic Field Test
EN 61000-4-11	Voltage Dips
EN 61547	Electromagnetic Immunity Requirements Applies to Lighting Equipment
DALI Standards	Notes
DALI	IEC62386-101,102 & part of 207 ⁽³⁾

- Notes:** (1) This product meets all requirements for EN=61347-1, A2:2013 Annex O (Double insulation). When the driver is energized, the allowed leakage current is perceptible but harmless.
- (2) This LED driver meets the EMI specifications above, but EMI performance of a luminaire that contains it depends also on the other devices connected to the driver and on the fixture itself.
- (3) Optional Commands Implemented: 242 (query short circuit), 243 (query open circuit).

Lifetime vs. Case Temperature

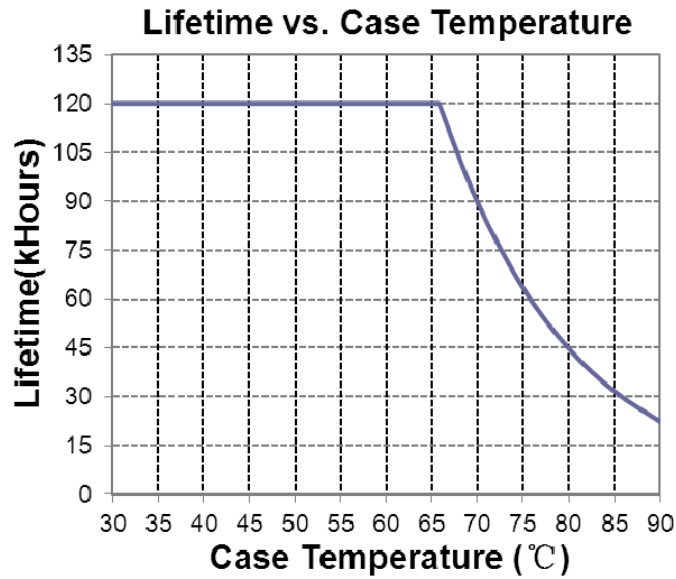

Inrush Current Waveform

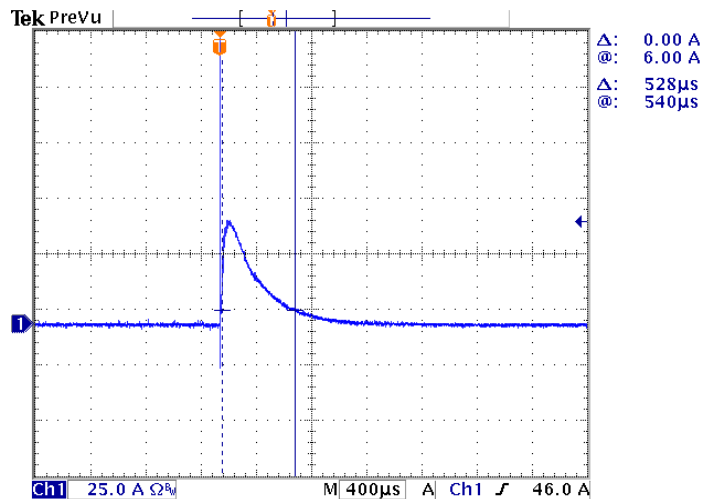

Efficiency vs. Load

LBD-075S100BSF ($I_o=700mA$)
Efficiency vs. Output Voltage

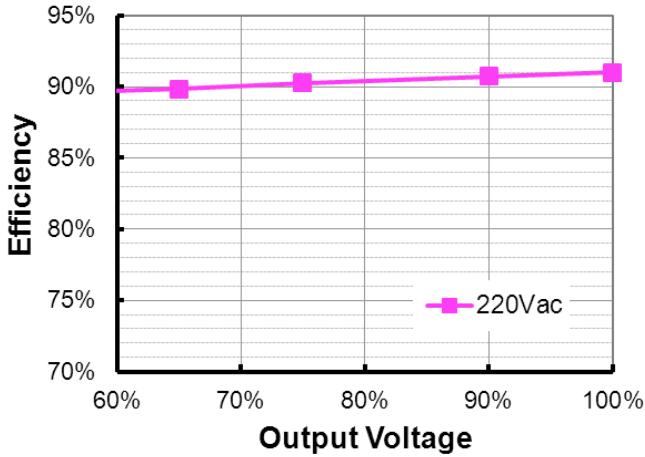

LBD-075S100BSF ($I_o=1000mA$)
Efficiency vs. Output Voltage

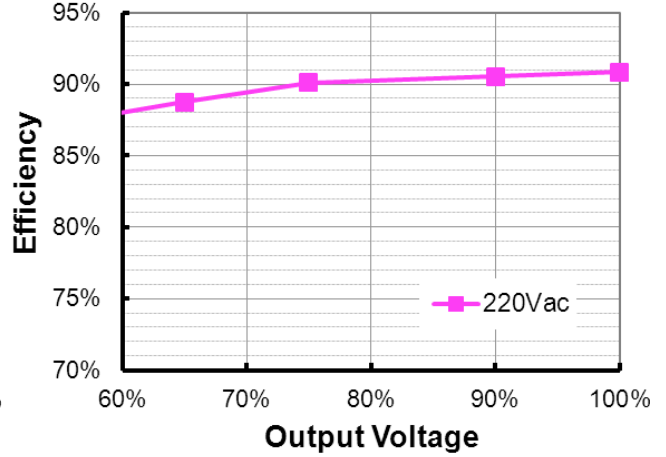

LBD-075S150BSF ($I_o=1050mA$)
Efficiency vs. Output Voltage

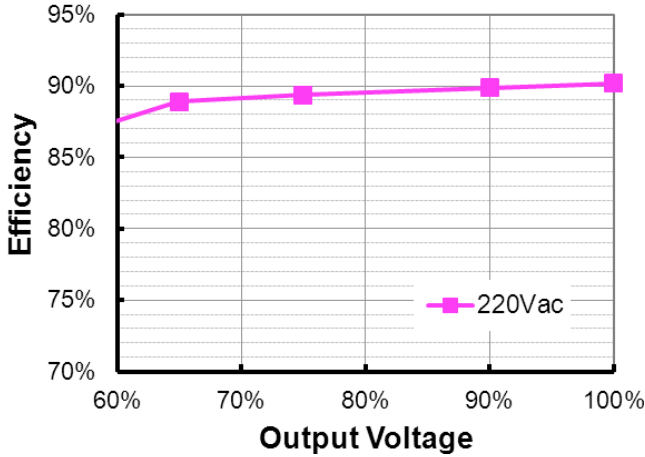

LBD-075S150BSF ($I_o=1500mA$)
Efficiency vs. Output Voltage

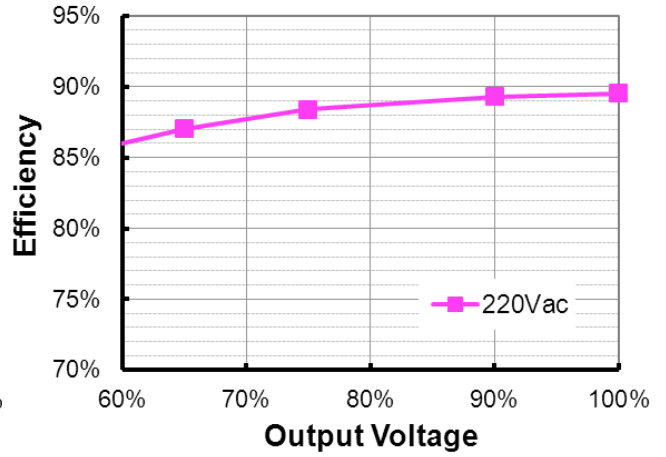

LBD-075S210BSF ($I_o=1470mA$)
Efficiency vs. Output Voltage

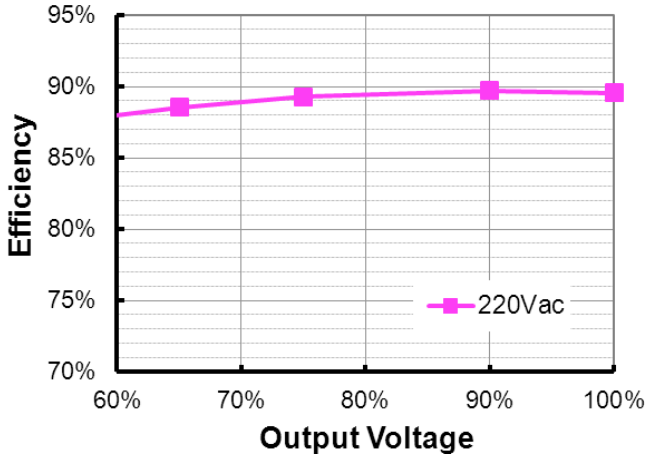

LBD-075S210BSF ($I_o=2100mA$)
Efficiency vs. Output Voltage

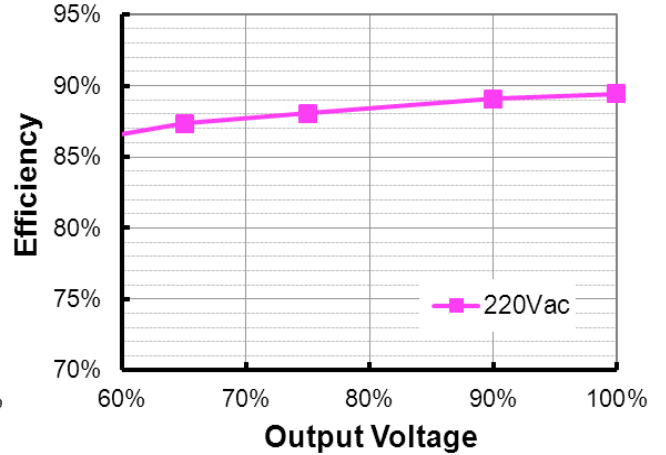

Power Factor

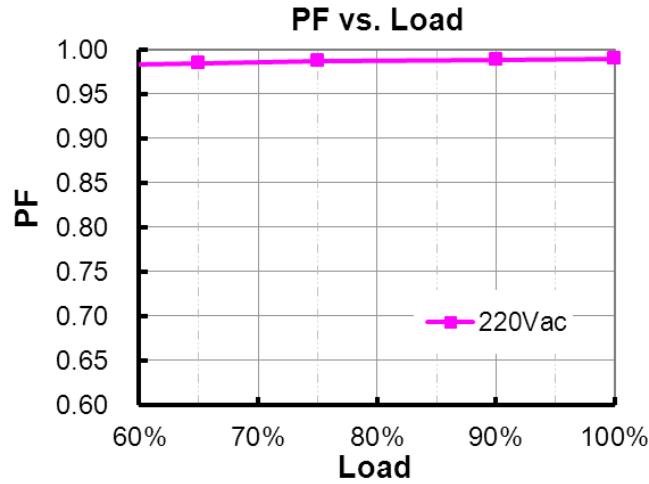

Total Harmonic Distortion

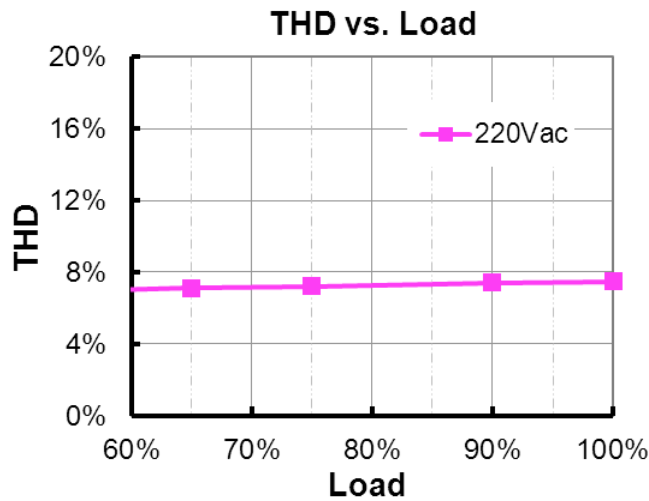

Protection Functions

Parameter		Min.	Typ.	Max.	Notes
Over Voltage Protection		Limits output voltage at no load and in case the normal voltage limit fails.			
Short Circuit Protection		Auto Recovery. No damage will occur when any output is short circuited. The output shall return to normal when the fault condition is removed.			
Over Temperature Protection		Decreases output current. Returning to normal after over temperature is removed.			
External Thermal Protection NTC	R1	-	7.81 kOhm	-	When R_NTC falls below R1, External Thermal Protection is triggered, reducing output current linearly until R2 is reached.
	R2		4.16 kOhm		When R_NTC is less than R2, output current is reduced to the programmed "Protection Current Floor."
	Protection Current Floor	10%loset	60%loset	100%loset	10%loset > Iomin (default setting is 60%)
		Iomin	60%loset	100%loset	10%loset ≤ Iomin (default setting is 60%)

Dimming

● DALI Dimming

The recommended implementation of the dimming control is provided below.

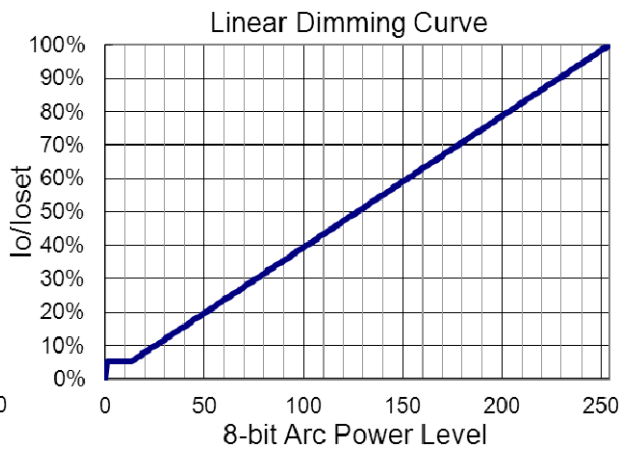
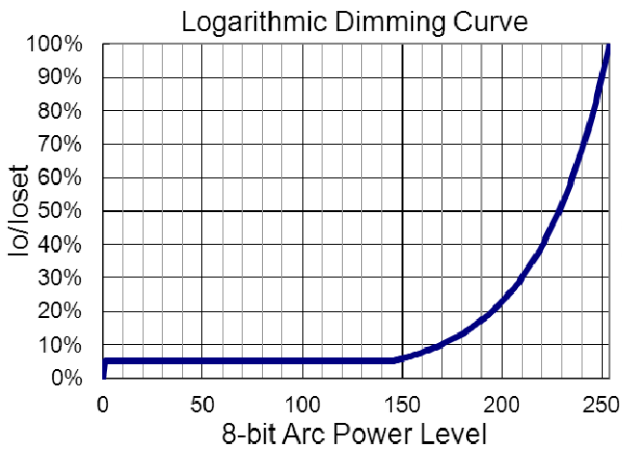
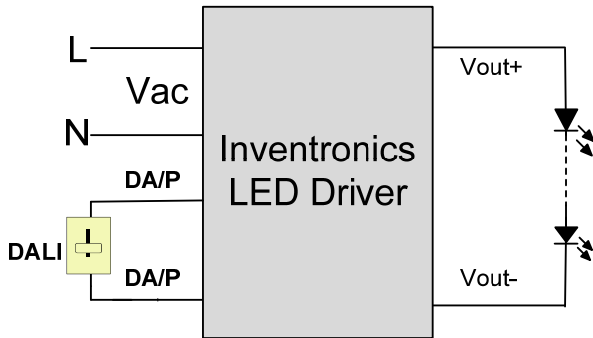

Implementation: DALI Dimming

● Push Dimming

Parameter	Min.	Typ.	Max.	Notes
Operated Input Voltage Range	176 V	-	264 V	
Dimming Output Range	5%IoSet	-	IoSet	70%IoMax ≤ IoSet ≤ 100%IoMax
	3.5%IoMax	-	IoSet	3.5%IoMax ≤ IoSet < 70%IoMax
Short push	0.1 s	-	0.6 s	Switch the device on or off
Long push	0.6 s	-	3.6 s	Dim the device up or down 1% every 32ms(Default)
Long push	0.6 s	-	6.6 s	Dim the device up or down 1% every 64ms
Long push	10 s	-	-	All devices will be synchronized to the same status 100%
Long push	20 s	-	-	Change the fading time between 3s and 6s

Notes:

1. Automatically identify DALI mode or push dimming mode, push dimming and DALI function can't be used at the same time.
2. The device has a memory function. This is used, among other things, for storing the last dimming value in the event of interruptions in the power supply. When power returns, the LED is automatically restored to its previous operating state and dimmed to the last value.

Wire Connection Diagram

● DALI Dimming

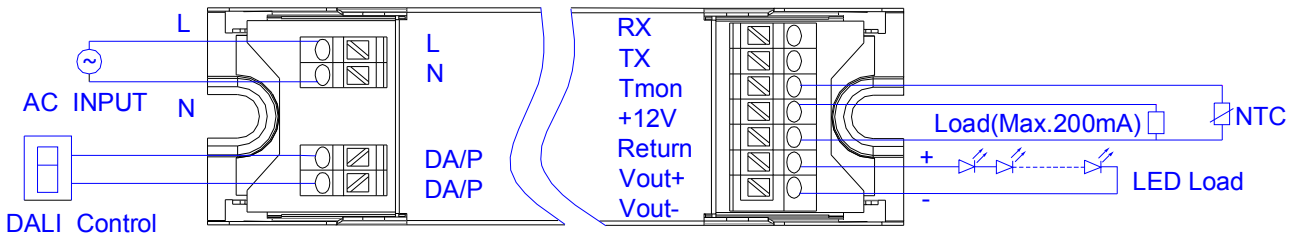

● Push Dimming

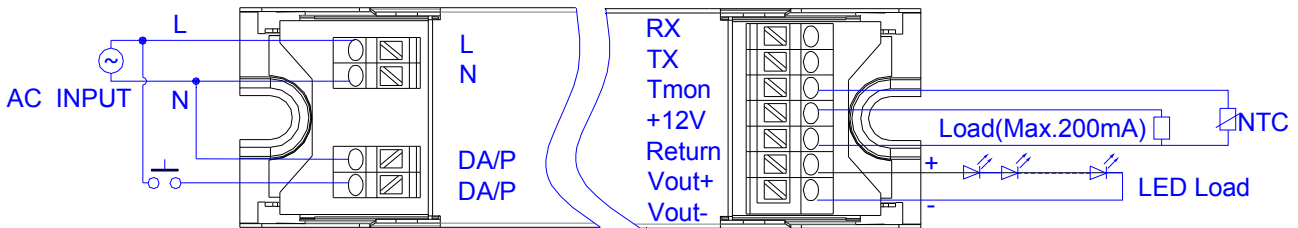

Programming Connection Diagram

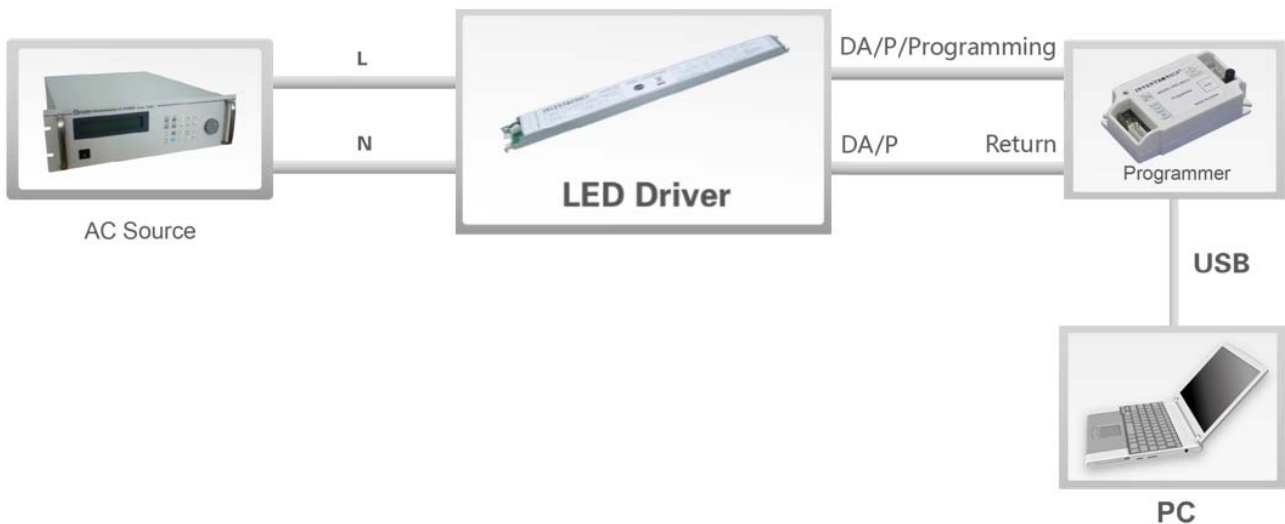

Note: The driver needs to be powered on during the programming process in this way.

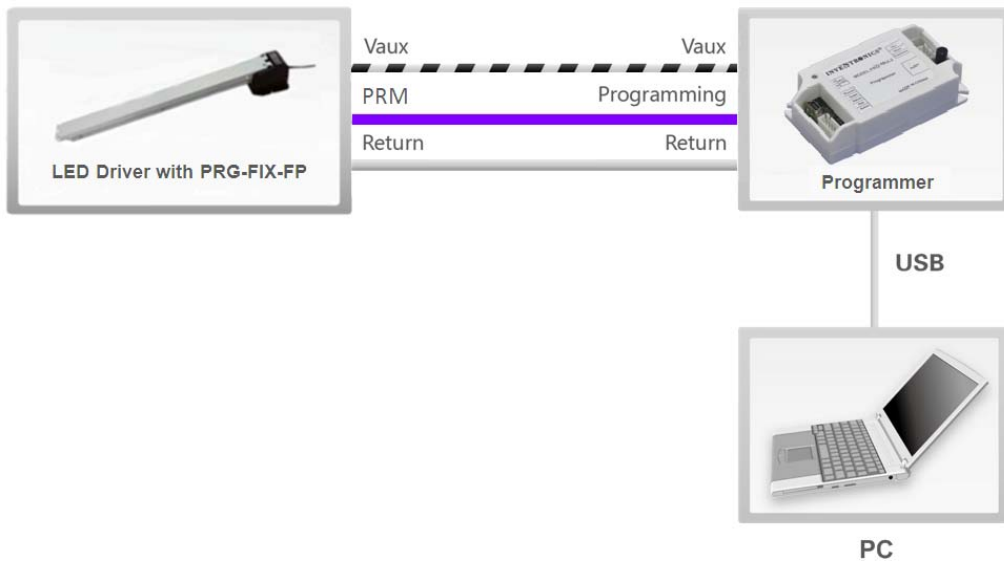

Note: The driver does not need to be powered on but needs a programming fixture during the programming process in this way.

- Please refer to [PRG-MUL2](#) (Programmer) and [PRG-FIX-FP](#) (Programming Fixture) datasheets for details.

Mechanical Outline

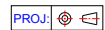
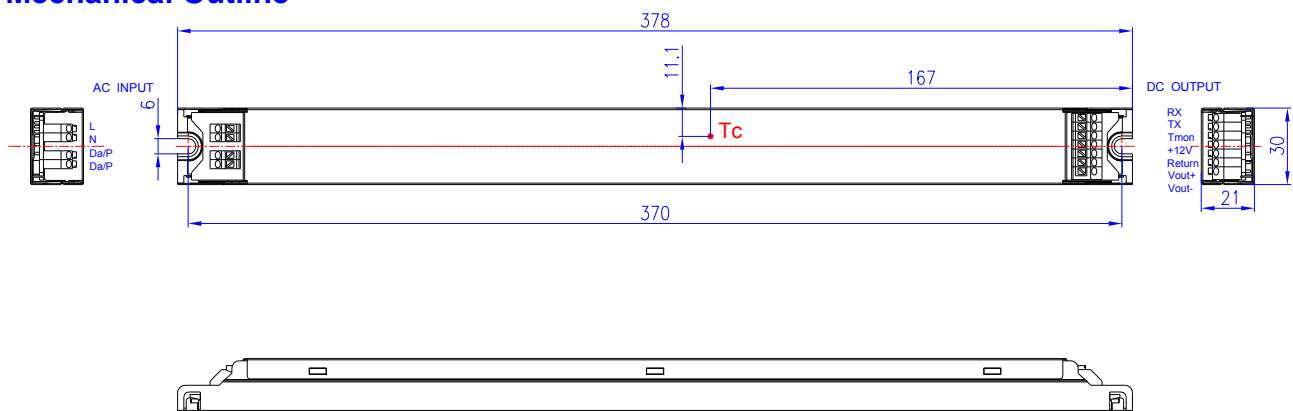

Unspecified tolerance: ±1

RoHS Compliance

Our products comply with reference to RoHS Directive (EU) 2015/863 amending 2011/65/EU, calling for the elimination of lead and other hazardous substances from electronic products.

Revision History

Change Date	Rev.	Description of Change		
		Item	From	To
2016-08-25	A	Datasheet Release	/	/
2019-08-20	B	TUV Logo	/	Updated
		ENEC Logo	/	Updated
		Description	/	Updated
		Safety &EMC Compliance	ENEC	Added
		Safety &EMC Compliance	TUV	Added
		Safety &EMC Compliance	CB	Added
		Safety &EMC Compliance	KS	Updated
		Safety &EMC Compliance	EN 61000-3-2	Updated
		Safety &EMC Compliance	EN 61000-4-5	Updated
		RoHS Compliance	/	Updated