

## Features

- High Efficiency (Up to 89%)
- Constant Output Current
- 0-10V Dimmable
- All-Around Protection: OVP, SCP ,OTP
- Waterproof (IP66) and UL Dry & Damp Location
- Class 2 & SELV Output
- Suitable for Built-in Use



## Description

The LUC-042SxxxDSP(SSP) series is a 42W, constant-current IP66 LED driver that operates from 90-305 Vac input with excellent power factor. They are created for down lights and panel lights etc. The high efficiency of these drivers enables them to run cooler, significantly improving reliability and extending product life. To ensure trouble-free operation, protection is provided against output over voltage, short circuit and over temperature.

## Models

Output Current	Input Voltage Range(1)	Output Voltage Range	Max. Output Power	Typical Efficiency (2)	Power Factor (2)	Model Number
700 mA	90 ~ 305 Vac 127 ~ 300 Vdc	28~56 Vdc	39 W	89%	0.95	LUC-042S070DSP(SSP) <sup>(4)</sup>
1400 mA	90 ~ 305 Vac 127 ~ 300 Vdc	15~30 Vdc	42 W	89%	0.95	LUC-042S140DSP(SSP) <sup>(3)(4)</sup>

**Notes:** (1) UL, FCC certified input voltage range: 100~277Vac/ 127~300Vdc; other certified input voltage range except UL & FCC: 100~240Vac/127~250Vdc (except CCC).

(2) Measured at full load and 220 Vac input.

(3) Certificates have got UL, FCC, CE.

(4) Class 2 & SELV Output.

## Input Specifications

Parameter	Min.	Typ.	Max.	Notes
Input Voltage	90 V	-	305 V	127-300Vdc
Input Frequency	47 Hz	-	63 Hz	
Leakage Current	-	-	0.75 MIU	UL8750; 277Vac/ 60Hz
	-	-	0.70 mA	IEC60598-1; 240Vac/ 60Hz
Input AC Current	-	-	0.6 A	Measured at full load and 100 Vac input.
	-	-	0.3 A	Measured at full load and 220 Vac input.
Inrush Current(I <sup>2</sup> t)	-	-	0.003 A <sup>2</sup> s	At 220Vac input 25°C Cold Start. Duration=28.8 μs, 10%Ipk-10%Ipk. See Inrush Current Waveform for the details.
Power Factor	0.90	-	-	At 100-277 Vac, 75%-100%Load (31.5~42W)

## Input Specifications (Continued)

Parameter	Min.	Typ.	Max.	Notes
THD	-	-	20%	At 100-277 Vac, 75%-100%Load (31.5~42W)

## Output Specifications

Parameter	Min.	Typ.	Max.	Notes
Output Current Range	-5%Io	-	5%Io	
Total Output voltage Ripple (pk-pk)	-	-	4 V	At full load condition, 20 MHz BW
Output Current Overshoot / Undershoot	-	-	10%Io	At full load condition.
No Load Output Voltage LUC-042S070DSP(SSP) LUC-042S140DSP(SSP)	- -	- -	59.9 V 35.0 V	
Line Regulation	-	-	±1 %	Measured at full load.
Load Regulation	-	-	±3 %	
Turn-on Delay Time	-	0.4 s	0.75 s	Measured at 120Vac input, 75%-100%Load
	-	0.3 s	0.5 s	Measured at 220Vac input, 75%-100%Load
Temperature Coefficient	-	0.03%/°C	-	Case temperature = 0°C ~Tc max
12V Auxiliary Output Voltage	10.8 V	12 V	13.2 V	
12V Auxiliary Output Source Current	0 mA	-	20 mA	Return terminal is "Dim-"

**Note:** All specifications are tested by YW-PWH01 and typical at 25°C unless otherwise stated.

## General Specifications

Parameter	Min.	Typ.	Max.	Notes
Efficiency at 120 Vac input: LUC-042S070DSP(SSP) LUC-042S140DSP(SSP)	86% 85%	88% 87%	- -	Measured at full load and steady-state temperature in 25°C ambient; (Efficiency will be about 1.0% lower if measured immediately after startup.)
Efficiency at 220 Vac input: LUC-042S070DSP(SSP) LUC-042S140DSP(SSP)	87% 87%	89% 89%	- -	Measured at full load and steady-state temperature in 25°C ambient; (Efficiency will be about 1.0% lower if measured immediately after startup.)
Efficiency at 277 Vac input: LUC-042S070DSP(SSP) LUC-042S140DSP(SSP)	87% 87%	89% 89%	- -	Measured at full load and steady-state temperature in 25°C ambient; (Efficiency will be about 1.0% lower if measured immediately after startup.)
No Load Power Dissipation	-	-	6 W	
MTBF	-	270,000 Hours	-	Measured at 220Vac input, 80%Load and 25°C ambient temperature (MIL-HDBK-217F)

## General Specifications (Continued)

Parameter	Min.	Typ.	Max.	Notes
Lifetime	-	67,000 Hours	-	Measured at 120Vac input, 80%Load and 70°C Case temperature. See life time vs. Tc curve for the details
Operating Case Temperature for Safety Tc_s	-40°C	-	+89°C	
Operating Case Temperature for Warranty Tc_w	-40°C	-	+75°C	Humidity: 10% RH to 100% RH.
Storage Temperature	-40°C	-	+85°C	Humidity: 5% RH to 100% RH
Dimensions Inches (L x W x H) Millimeters (L x W x H)	3.74 x 2.76 x 1.26 95 x 70 x 32			
Net Weight	-	385 g	-	

**Note:** All specifications are tested by YW-PWH01 and typical at 25°C unless otherwise stated.

## Dimming Specifications

Parameter	Min.	Typ.	Max.	Notes
Absolute Maximum Voltage on the Vdim (+) Pin	-20 V	-	20 V	
Source Current on Vdim (+) Pin	0 uA	200 uA	250 uA	
Dimming Output Range	10%Iomax	-	100%Iomax	
Recommended Dimming Input Range	0 V	-	10 V	

## Safety & EMC Compliance

Safety Category	Standard
UL/CUL	UL 8750,UL1310,CAN/CSA-C22.2 No. 250.13,CAN/CSA-C22.2 No. 223-M91
CE	EN 61347-1, EN61347-2-13
CCC	GB 19510.1, GB 19510.14
KS	KS C 7655
EMI Standards	Notes
EN 55015 <sup>(1)</sup>	Conducted emission Test & Radiated emission Test
EN 55015 <sup>(1)</sup> /GB 17743	Harmonic Current Emissions
EN 61000-3-2/GB 17625.1	Voltage Fluctuations & Flicker

## Safety & EMC Compliance (Continued)

EMI Standards	Notes
FCC Part 15 <sup>(1)</sup>	ANSI C63.4 Class B
	This device complies with Part 15 of the FCC Rules. Operation is subject to the following two conditions: [1] this device may not cause harmful interference, and [2] this device must accept any interference received, including interference that may cause undesired operation.
EMS Standards	Notes
EN 61000-4-2	Electrostatic Discharge (ESD): 8 kV air discharge, 4 kV contact discharge
EN 61000-4-3	Radio-Frequency Electromagnetic Field Susceptibility Test-RS
EN 61000-4-4	Electrical Fast Transient / Burst-EFT
EN 61000-4-5	Surge Immunity Test: AC Power Line: line to line 2 kV
EN 61000-4-6	Conducted Radio Frequency Disturbances Test-CS
EN 61000-4-8	Power Frequency Magnetic Field Test
EN 61000-4-11	Voltage Dips
EN 61547	Electromagnetic Immunity Requirements Applies To Lighting Equipment

**Note:** (1) This LED driver meets the EMI specifications above, but EMI performance of a luminaire that contains it depends also on the other devices connected to the driver and on the fixture itself.

## Lifetime vs. Case Temperature

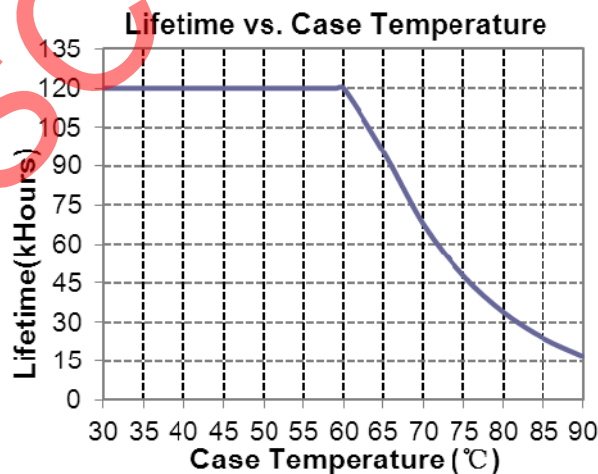

## Inrush Current Waveform

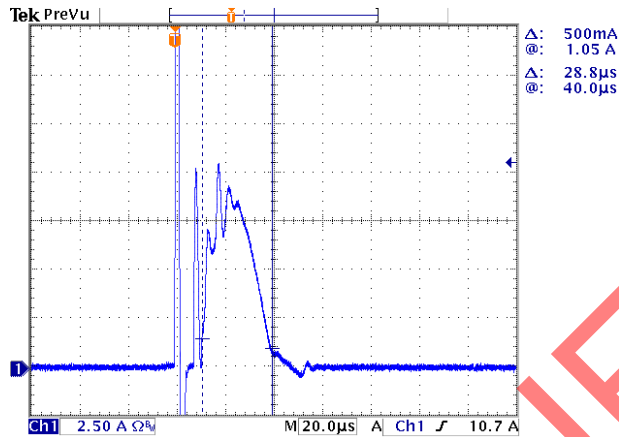

## Efficiency vs. Load

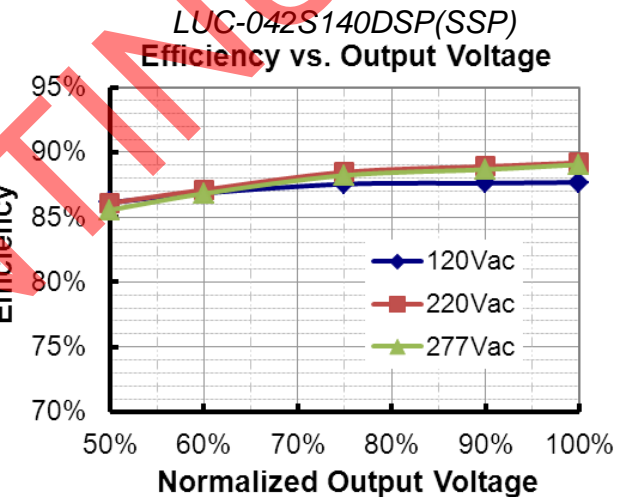
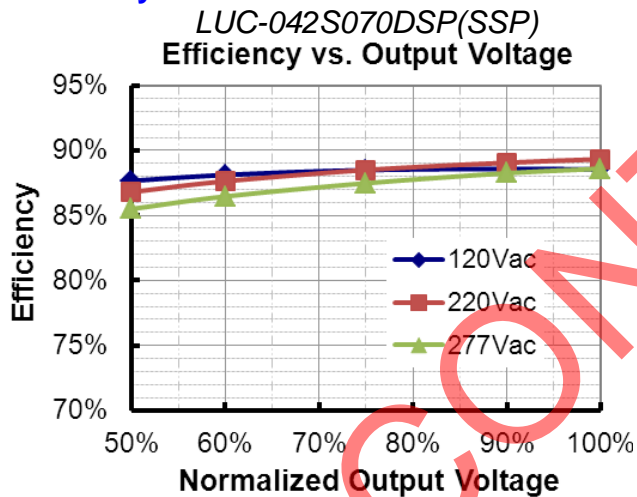

## Power Factor

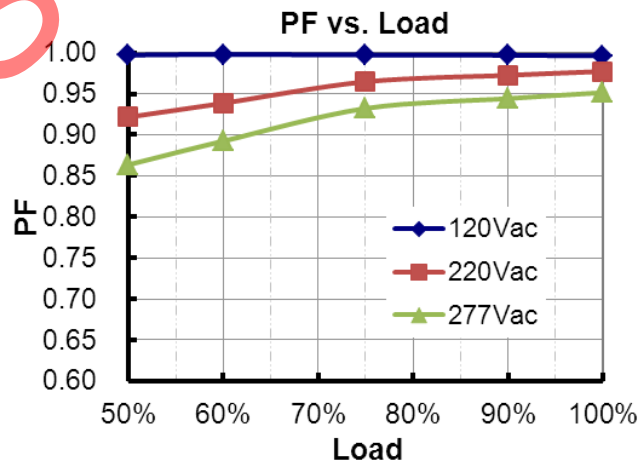

## Total Harmonic Distortion

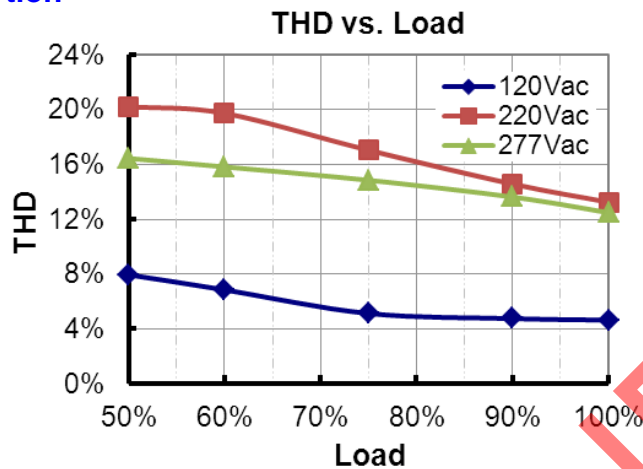

## Protection Functions

Parameter	Notes
Over Temperature Protection	Auto Recovery. Returning to normal after over temperature is removed.
Short Circuit Protection	Auto Recovery. No damage shall occur when any output operating in a short circuit condition. The power supply shall be self-recovery when the fault condition is removed.
Over Voltage Protection	Limits output voltage at no load and in case the normal voltage limit fails.

## Dimming

### ● 0-10V Dimming

The recommended implementation of the dimming control is provided below.

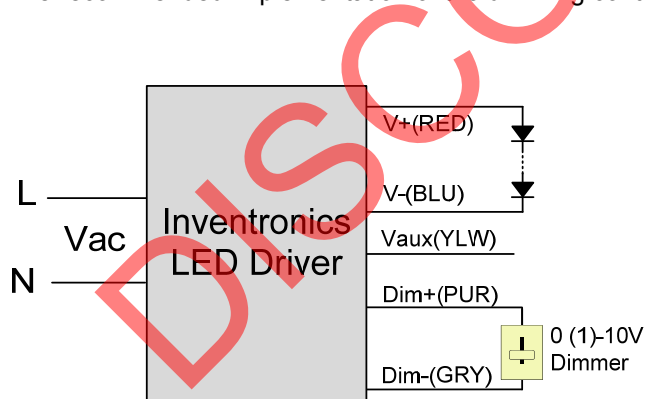

Io/Iomax vs. Dimming Voltage

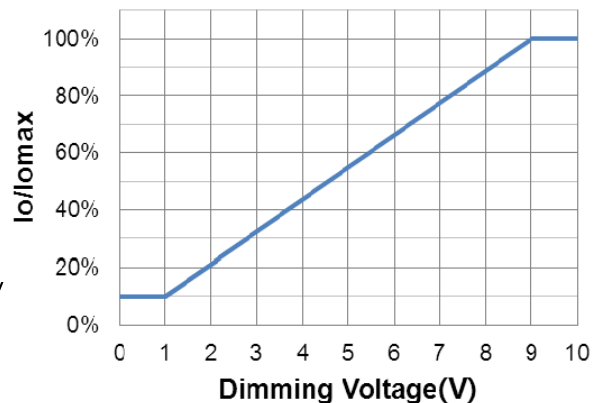

Implementation 1: DC Input

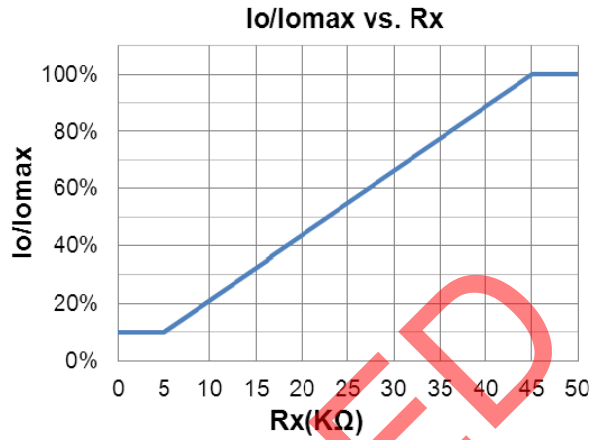
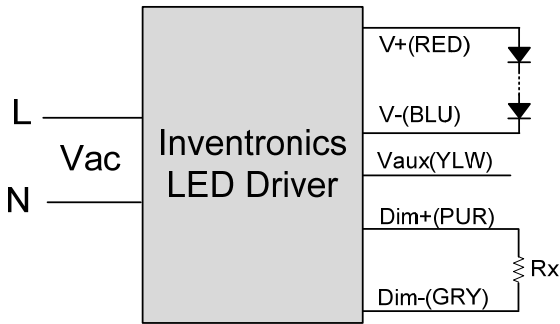

### Implementation 2: External Resistor

#### Notes:

1. The dimmer can also be replaced by an active 0-10V voltage source signal or passive components like resistors and zener.
2. Do NOT connect Dim- to the output V- or V+, otherwise the driver will not work properly.
3. If 0-10V dimming is not used, Dim + can be either open or connected to Vaux.

#### Mechanical Outline

LUC-042SxxxDSP

LUC-042SxxxSSP

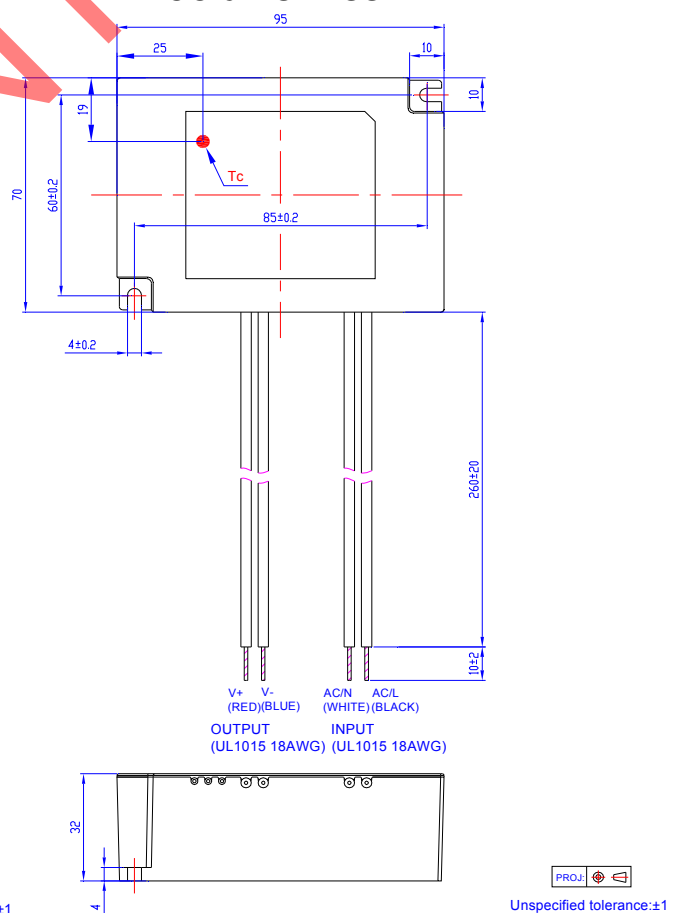
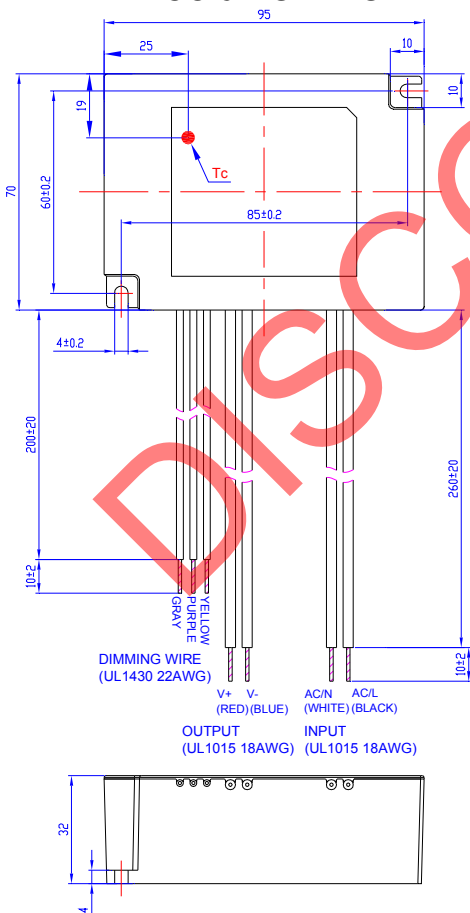

## RoHS Compliance

Our products comply with the European Directive 2011/65/EC, calling for the elimination of lead and other hazardous substances from electronic products.

DISCONTINUED



## Revision History

Change Date	Rev.	Description of Change		
		Item	From	To
2013-08-15	A	Datasheet Release	/	/
2015-05-05	B	Model LUC-042S140DSP(SSP)	/	Added
2016-08-02	C	Turn-on Delay Time at 120Vac	Max.=1.0 s	Max.=0.75 s
		Lifetime	120,000Hours at Tc =60°C	67,000Hours at Tc=70°C
		Net Weight	350 g	385 g
		KS Certificate Regulation	/	Added
		Note of EMI Standard	/	Added
2017-07-07	D	Mechanical Outline-Tc	/	Added

DISCONTINUED