

Features

- Adjustable Output Current (AOC) with NFC
- Full Power at Wide Output Current Range (Constant Power)
- Flicker-Free
- Isolated 1-10V Dimming Control (DT models)
Non-dimming Control (ST models)
- Minimum Dimming Level with 5% or 10% Settable (DT models)
- Input Surge Protection: DM 2kV, CM 2kV
- IP54 and UL Dry & Damp Location
- Class 2 & SELV output
- UL Class P Type
- Suitable for Class I Luminaires
- 5 Years Warranty



Description

The LUN-042SxxxDT(ST) series is a 42W, constant-power, programmable IP54 LED driver that operates from 90-305Vac input with excellent power factor. It is created for many lighting applications including panel and down lights, etc. it provides good dimming accuracy at low dimming level down to 5%, the high efficiency and better thermal design enable them to run cooler, significantly improving reliability and extending product life. To ensure trouble-free operation, protection is provided against over voltage, short circuit, and over temperature.

Models

Adjustable Output Current Range	Full-Power Current Range(1)	Default Output Current	Input Voltage Range(2)	Output Voltage Range	Max. Output Power	Typical Efficiency (3)	Typical Power Factor		Model Number (4)
							120Vac	220Vac	
234-1050 mA	780-1050 mA	1050 mA	90~305 Vac 127~250 Vdc	20~54 Vdc	42 W	87.5%	0.99	0.96	LUN-042S105DT(ST)
315-1500 mA	1050-1500 mA	1400 mA	90~305 Vac 127~250 Vdc	14~40 Vdc	42 W	86.0%	0.99	0.96	LUN-042S150DT(ST)

- Notes:** (1) Output current range with constant power at 42W.
 (2) Certified input voltage range: UL, FCC 100-277 Vac; otherwise: 100-240 Vac.
 (3) Measured at 100% load and 220Vac input (see below "General Specifications" for details).
 (4) Class 2 & SELV Output.

I-V Operating Area

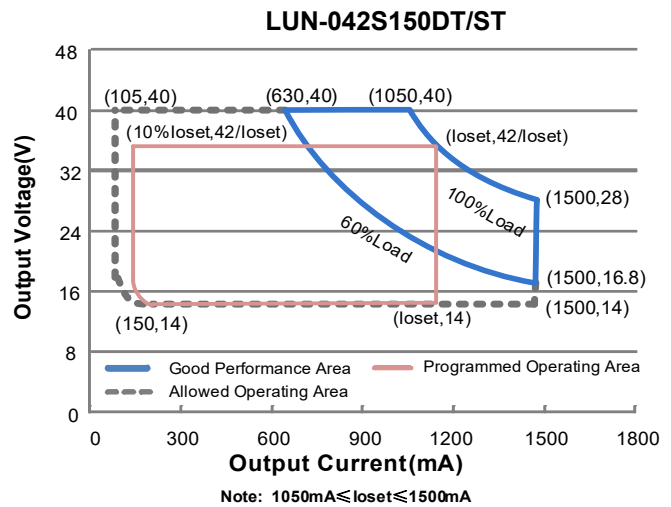
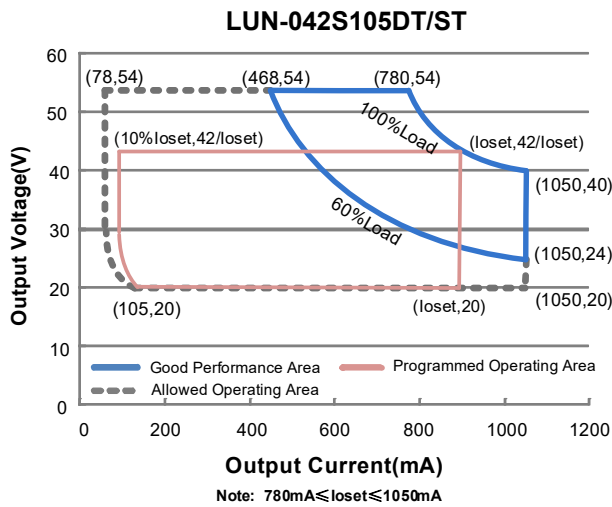

Note: The I-V Operating Area shows 10% - 100% dimming.

Input Specifications

Parameter	Min.	Typ.	Max.	Notes
Input AC Voltage	90 Vac	-	305 Vac	
Input DC Voltage	127 Vdc	-	250 Vdc	
Input Frequency	47 Hz	-	63 Hz	
Leakage Current	-	-	0.75 MIU	UL 8750; 277Vac/ 60Hz
	-	-	0.70 mA	IEC 60598-1; 240Vac/ 60Hz
Input AC Current	-	-	0.45 A	Measured at 100% load and 120 Vac input.
	-	-	0.25 A	Measured at 100% load and 220 Vac input.
Inrush Current(I ² t)	-	-	0.29 A ² s	At 220Vac input, 25°C cold start, duration=270 μs, 10%Ipk-10%Ipk. See Inrush Current Waveform for the details.
PF	0.9	-	-	At 100-277Vac,50-60Hz, 60%-100% load (25-42W)
THD	-	-	20%	
THD	-	-	10%	At 220-240Vac,50-60Hz,70%-100% load (29.5-42W)

Output Specifications

Parameter	Min.	Typ.	Max.	Notes	
Output Current Tolerance	-5%Ioset	-	5%Ioset	At 100% load condition	
Output Current Setting(Ioset) Range					
	LUN-042S105DT (ST)	234 mA	-	1050 mA	
	LUN-042S150DT (ST)	315 mA	-	1500 mA	

Output Specifications (Continued)

Parameter	Min.	Typ.	Max.	Notes
Output Current Setting Range with Constant Power LUN-042S105DT (ST) LUN-042S150DT (ST)	780 mA 1050 mA	- -	1050 mA 1500 mA	
Total Output Current Ripple (pk-pk)	-	10%I _o max	20%I _o max	At 100% load condition. 20 MHz BW
Output Current Ripple at < 200 Hz (pk-pk)	-	2%I _o max	-	At 100% load condition. Only this component of ripple is associated with visible flicker.
Startup Overshoot Current	-	-	10%I _o max	At 100% load condition
No Load Output Voltage LUN-042S105DT (ST) LUN-042S150DT (ST)	- -	- -	60 V 60 V	
Line Regulation	-	-	±1%	Measured at 100% load
Load Regulation	-	-	±5%	
Turn-on Delay Time	-	-	0.5 s	Measured at 120-277Vac input, 60%-100%load
Temperature Coefficient of I _o set	-	0.06%/°C	-	Case temperature = 0°C~T _c max
12V Auxiliary Output Voltage	10.8 V	12 V	13.2 V	
12V Auxiliary Output Source Current	0 mA	-	20 mA	Return terminal is "Dim"

General Specifications

Parameter	Min.	Typ.	Max.	Notes
Efficiency at 120 Vac input: LUN-042S105DT(ST) I _o =780 mA I _o =1050 mA LUN-042S150DT(ST) I _o =1050 mA I _o =1500 mA	83.0% 83.0%	85.0% 85.0%	- -	Measured at 100% load and steady-state temperature in 25°C ambient; (Efficiency will be about 2.0% lower if measured immediately after startup.)
Efficiency at 220 Vac input: LUN-042S105DT(ST) I _o =780 mA I _o =1050 mA LUN-042S150DT(ST) I _o =1050 mA I _o =1500 mA	85.0% 85.5%	87.0% 87.5%	- -	Measured at 100% load and steady-state temperature in 25°C ambient; (Efficiency will be about 2.0% lower if measured immediately after startup.)
Efficiency at 277 Vac input: LUN-042S105DT(ST) I _o =780 mA I _o =1050 mA LUN-042S150DT(ST) I _o =1050 mA I _o =1500 mA	85.0% 86.0%	87.0% 88.0%	- -	Measured at 100% load and steady-state temperature in 25°C ambient; (Efficiency will be about 2.0% lower if measured immediately after startup.)
MTBF	-	281,000 hours	-	Measured at 220Vac input, 80%Load and 25°C ambient temperature (MIL-HDBK-217F)

General Specifications (Continued)

Parameter	Min.	Typ.	Max.	Notes
Lifetime	-	87,000 hours	-	Measured at 120Vac input, 80%Load and 70°C case temperature; See lifetime vs. Tc curve for the details
Operating Case Temperature for Safety Tc_s	-40 °C	-	+85 °C	
Operating Case Temperature for Warranty Tc_w	-40 °C	-	+75 °C	Case temperature for 5 years warranty. Humidity: 10% RH to 90% RH No Condensation
Storage Temperature	-40 °C	-	+85 °C	Humidity: 5% RH to 95% RH No Condensation
Audible Noise	-	-	24 dB	Class A
Dimensions Inches (L × W × H) Millimeters (L × W ×H)	3.74 × 2.76 × 1.26 95 × 70 × 32			
Net Weight	-	360 g	-	

Dimming Specifications

Parameter	Min.	Typ.	Max.	Notes	
Absolute Maximum Voltage on the Vdim (+) Pin	-20 V	-	20 V		
Source Current on Vdim (+)Pin	200 uA	300 uA	450 uA	Vdim(+) = 0 V	
Dimming Output Range with 10%-100% (Default)	LUN-042S105DT	10%loset	-	loset	780 mA ≤ loiset ≤ 1050 mA
	LUN-042S150DT				1050 mA ≤ loiset ≤ 1500 mA
Dimming Output Range with 5%-100% (Settable)	LUN-042S105DT	78 mA	-	loset	234 mA ≤ loiset < 780 mA
	LUN-042S150DT	105 mA	-	loset	315 mA ≤ loiset < 1050 mA
Dimming Output Range with 5%-100% (Settable)	LUN-042S105DT	5%loset	-	loset	780 mA ≤ loiset ≤ 1050 mA
	LUN-042S150DT				1050 mA ≤ loiset ≤ 1500 mA
Dimming Output Range with 5%-100% (Settable)	LUN-042S105DT	35 mA	-	loset	234 mA ≤ loiset < 780 mA
	LUN-042S150DT	53 mA	-	loset	315 mA ≤ loiset < 1050 mA

Safety & EMC Compliance

Safety Category	Standard
UL/CUL	UL 8750,UL1310,CAN/CSA-C22.2 No. 250.13,CAN/CSA-C22.2 No. 223-M91
CE	EN 61347-1, EN 61347-2-13 EN 301 489-1 EN 301 489-3 EN 300 330 EN 62479/EN 50663/EN 50665/EN 50364
CB	IEC 61347-1, IEC 61347-2-13
KS	KS C 7655
NOM	NOM-058-SCFI

Safety & EMC Compliance (Continued)

EMI Standards	Notes
EN IEC 55015 ⁽¹⁾	Conducted emission Test & Radiated emission Test
EN IEC 61000-3-2	Harmonic current emissions
EN 61000-3-3	Voltage Fluctuations & Flicker
FCC Part 15 ⁽¹⁾	ANSI C63.4 Class B
	This device complies with Part 15 of the FCC Rules. Operation is subject to the following two conditions: [1] this device may not cause harmful interference, and [2] this device must accept any interference received, including interference that may cause undesired operation.
EMS Standards	Notes
EN 61000-4-2	Electrostatic Discharge(ESD): 8 kV air discharge, 4 kV contact discharge
EN 61000-4-3	Radio-Frequency Electromagnetic Field Susceptibility Test-RS
EN 61000-4-4	Electrical Fast Transient/Burst-EFT
EN 61000-4-5	Surge Immunity Test: AC Power Line: Differential Mode 2 kV, Common Mode 2 kV
EN 61000-4-6	Conducted Radio Frequency Disturbances Test-CS
EN 61000-4-8	Power Frequency Magnetic Field Test
EN 61000-4-11	Voltage Dips
EN 61547	Electromagnetic Immunity Requirements Applies to Lighting Equipment

Note: (1) This LED driver meets the EMI specifications above, but EMI performance of a luminaire that contains it depends also on the other devices connected to the driver and on the fixture itself.

Derating

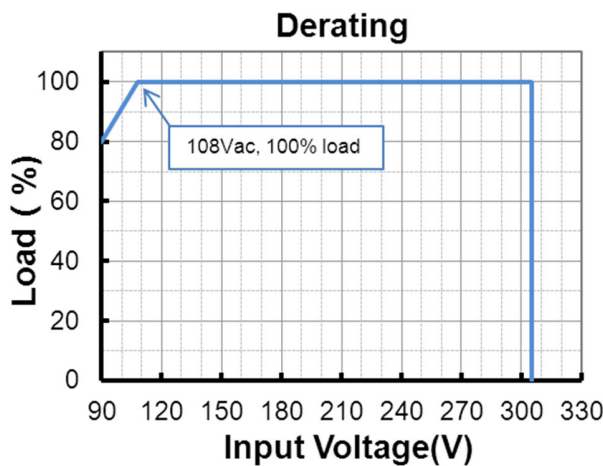

Lifetime vs. Case Temperature

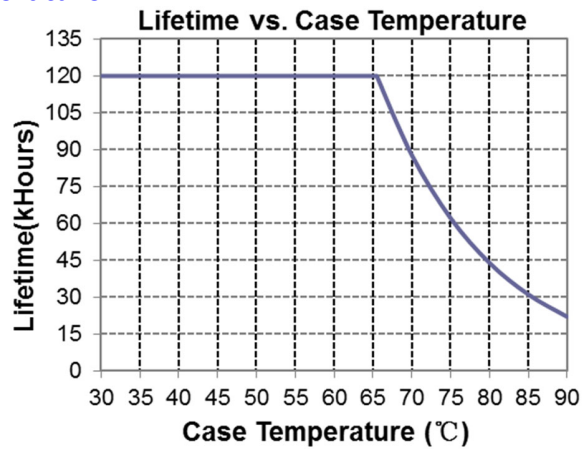

Inrush Current Waveform

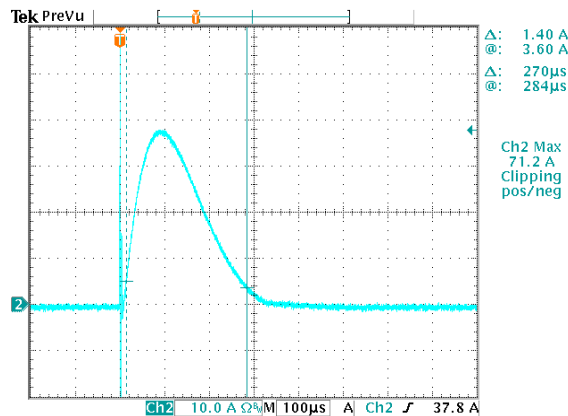

Efficiency vs. Load

LUN-042S105DT(ST) (Io=780mA)
Efficiency vs. Output Voltage

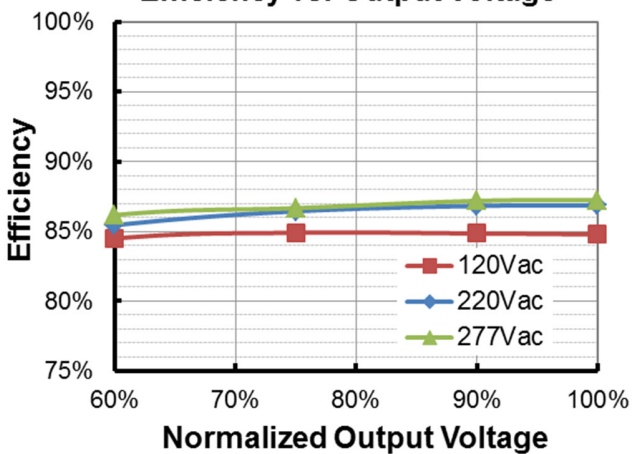

LUN-042S105DT(ST) (Io=1050mA)
Efficiency vs. Output Voltage

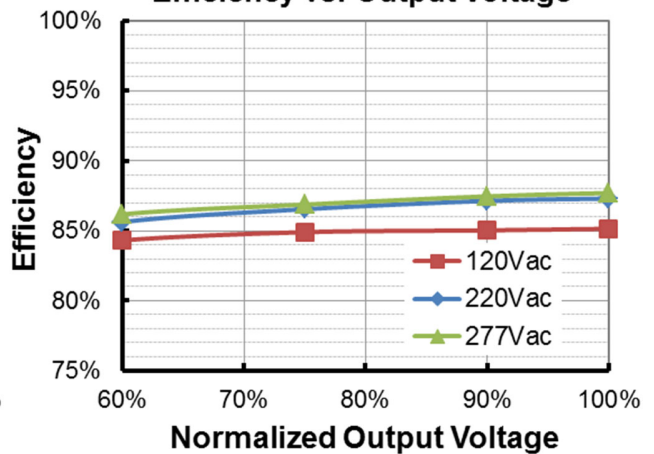

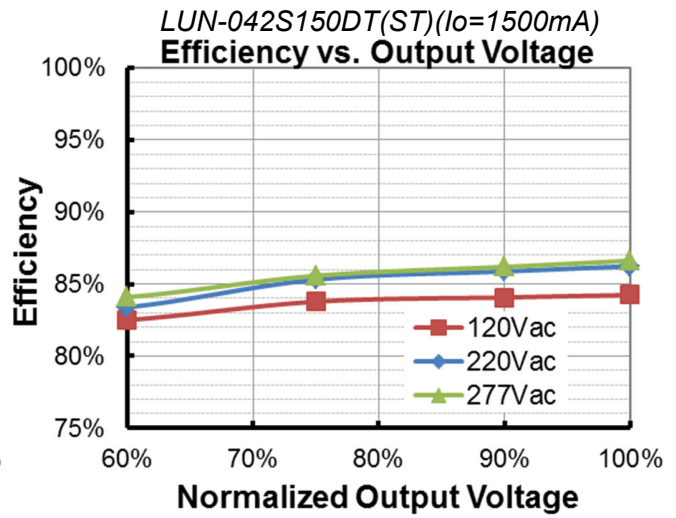
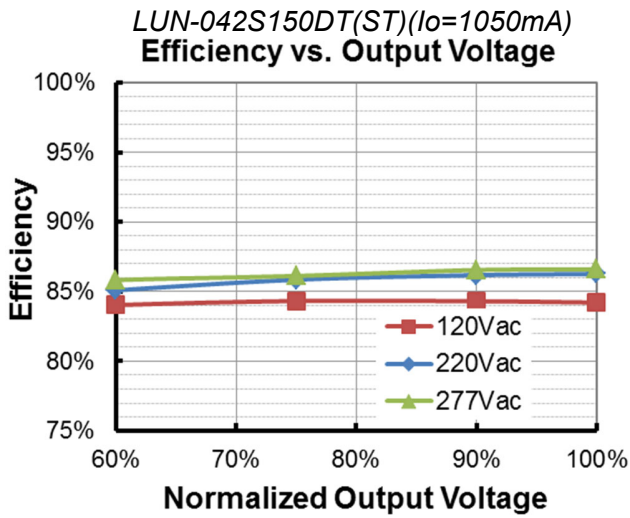

Power Factor

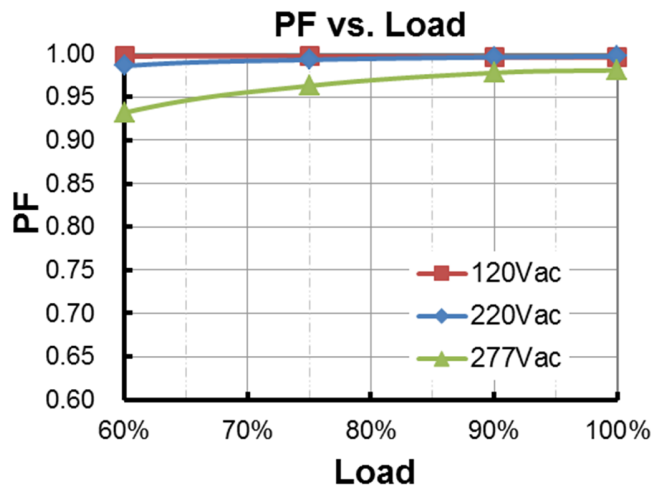

Total Harmonic Distortion

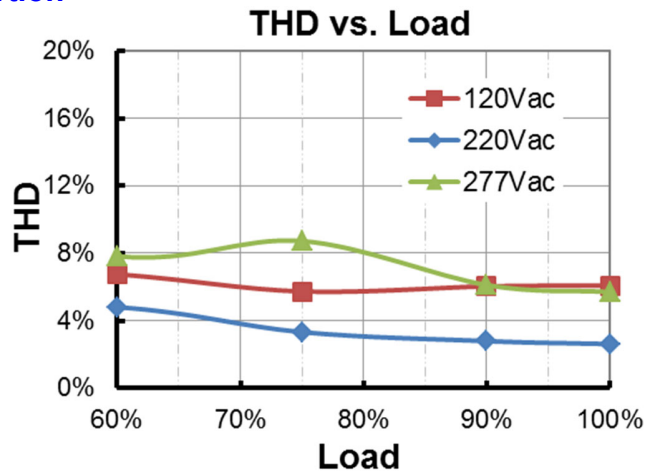

Protection Functions

Parameter	Notes
Over Temperature Protection	Decreases output current, returning to normal after over temperature is removed.
Short Circuit Protection	Auto Recovery. No damage will occur when any output is short circuited. The output shall return to normal when the fault condition is removed.
Over Voltage Protection	Limits output voltage at no load and in case the normal voltage limit fails.

Dimming

● 1-10V Dimming (Only DT models)

The recommended implementation of the dimming control is provided below.

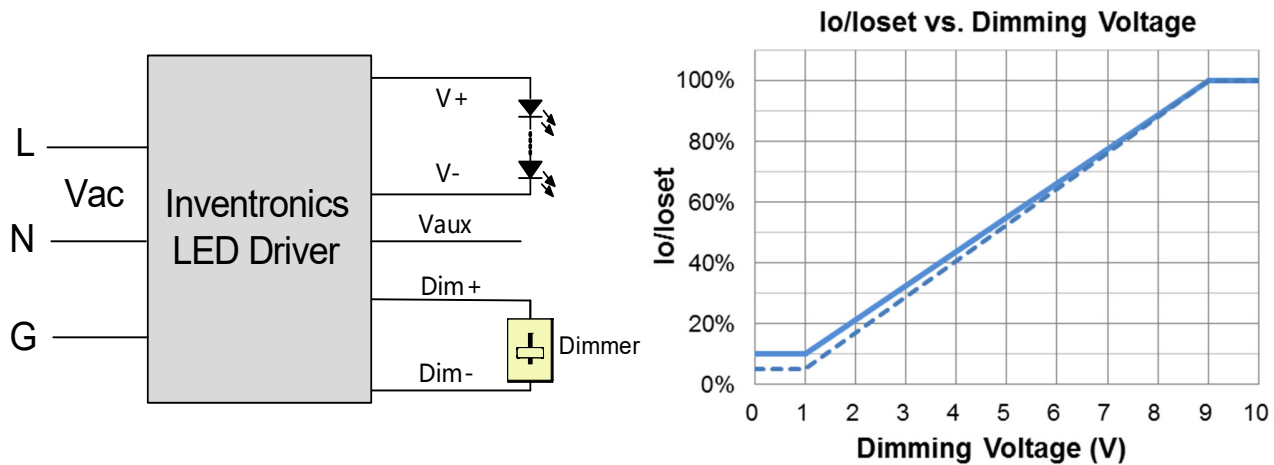

Notes:

1. Do NOT connect Dim- to the output V- or V+, otherwise the driver will not work properly.
2. The dimmer can also be replaced by an active 1-10V voltage source signal or passive components like zener.

Programming Connection Diagram

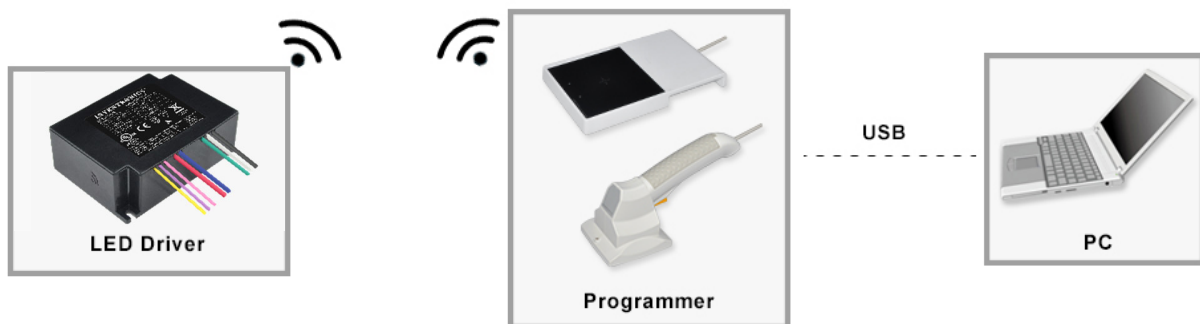

Note: The driver does not need to be powered on during the programming process.

- Please refer to [PRG-NFC-H](#) or [PRG-NFC-D2](#) (Programmer) datasheet for details.

Mechanical Outline

LUN-042SxxxDT

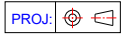
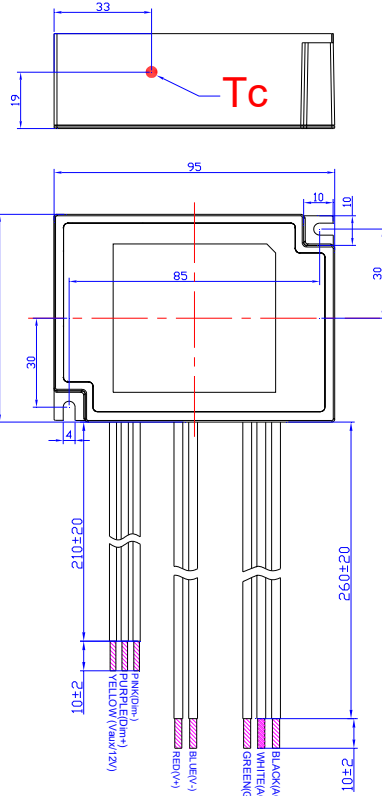

Unspecified tolerance:±1

DIMMING WIRE (UL1430 22AWG) DC OUTPUT (UL1015 18AWG) AC INPUT (UL1015 18AWG)

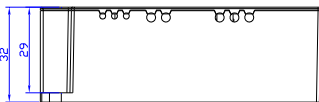

LUN-042SxxxST

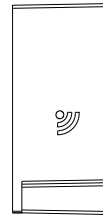
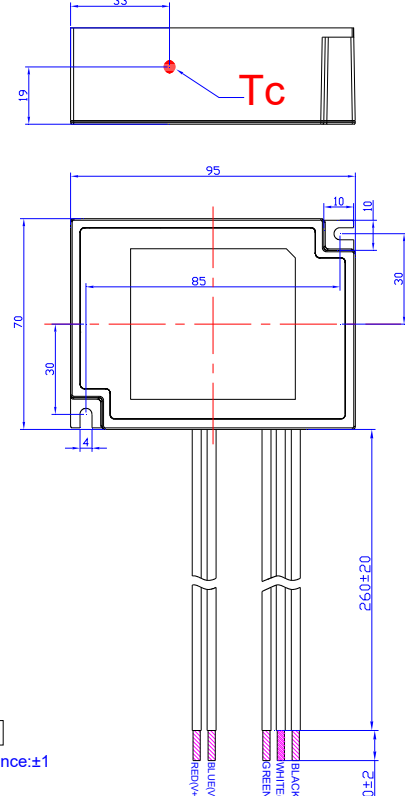

Unspecified tolerance:±1

DC OUTPUT (UL1015 18AWG) AC INPUT (UL1015 18AWG)

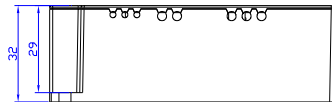

RoHS Compliance

Our products comply with reference to RoHS Directive (EU) 2015/863 amending 2011/65/EU, calling for the elimination of lead and other hazardous substances from electronic products.

Revision History

Change Date	Rev.	Description of Change		
		Item	From	To
2019-12-19	A	Datasheets Release	/	/
2022-02-18	B	Product Photograph	/	Updated
		NOM logo	/	Added
		Safety &EMC Compliance	NOM	Added
		Dimming	Notes	Updated
		Programming Connection Diagram	/	Updated
		Mechanical Outline	LUN-042SxxxDT	Updated
2023-10-08	C	ENEC logo	/	Deleted
		Product Photograph	/	Updated
		Safety &EMC Compliance	/	Updated