

Features

- Full Power at Wide Output Current Range (Constant Power)
- Adjustable Output Current (AOC) with NFC
- DALI-2 and D4i Certified
- AC Dim/3-Timer-Modes Dimmable
- Dim-to-Off with Standby Power $\leq 0.5\text{ W}$
- Always-on Auxiliary Power: 24Vdc, 125mA, 3W (Transient Peak Power up to 10W)
- Integrated 16Vdc Bus Power Supply Based on DALI-2
- Integrated Power Monitoring with High Accuracy up to $\pm 1\%$
- Output Lumen Compensation
- End-of-Life Indicator
- Thermal Sensing and Protection for LED Module
- Long Lifetime Over 100K Hours at 75°C Case Temperature
- Input Surge Protection: DM 6 kV, CM 10 kV
- All-Around Protection: IUVP, IOVP, OVP, SCP, OTP
- IP20 Design and Suitable for Outdoor Applications in Luminaires with IP>54
- Suitable for Luminaires with Protection Class I and II
- Complies with Zhaga Interface Specification Book 13
- 8 Year Warranty



Description

The EBS-080SxxxBT2 series is a 80W, constant-current, NFC programmable and IP20 rated LED driver that operates from 176-305 Vac input with excellent power factor. Created for many lighting applications including street, tunnel and low bay, etc., this family provides integrated AC power monitoring with an auxiliary voltage and dim-to-off functionality for powering low voltage, wireless controls. The dimming control supports two-way communication via DALI-2 and complies with D4i. The high efficiency of these drivers and better thermal design enable them to run cooler, significantly improving reliability and extending product life. To ensure trouble-free operation, protection is provided against input surge, input under voltage, input over voltage, output over voltage, short circuit, and over temperature of both the driver and the external LED array.

Models

Adjustable Output Current Range	Full-Power Current Range(1)	Default Output Current	Input Voltage Range(2)	Output Voltage Range	Max. Output Power	Typical Efficiency (3)	Typical Power Factor (3)	Model Number (5)
45-700mA	450-700mA	530 mA	176~305 Vac 171~275 Vdc	57~178 Vdc	80 W	92.5%	0.98	EBS-080S070BT2
70-1050mA	700-1050mA	700 mA	176~305 Vac 171~275 Vdc	38~114 Vdc	80 W	92.5%	0.98	EBS-080S105BT2 ⁽⁴⁾
105-1500mA	1050-1500mA	1050 mA	176~305 Vac 171~275 Vdc	27 ~ 76 Vdc	80 W	92.0%	0.98	EBS-080S150BT2 ⁽⁴⁾

- Notes:** (1) Output current range with constant power at 80W.
 (2) CCC certified input voltage range: 220-240 Vac; other certified input voltage range except CCC: 200-240 Vac.
 (3) Measured at 100% load and 220Vac input (see below "General Specifications" for details).
 (4) SELV output.
 (5) All the models are certificated to BIS, except EBS-080S070BT2.

I-V Operating Area

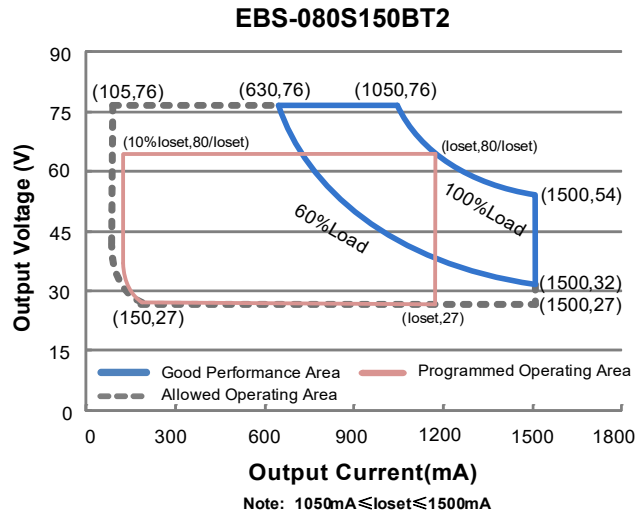
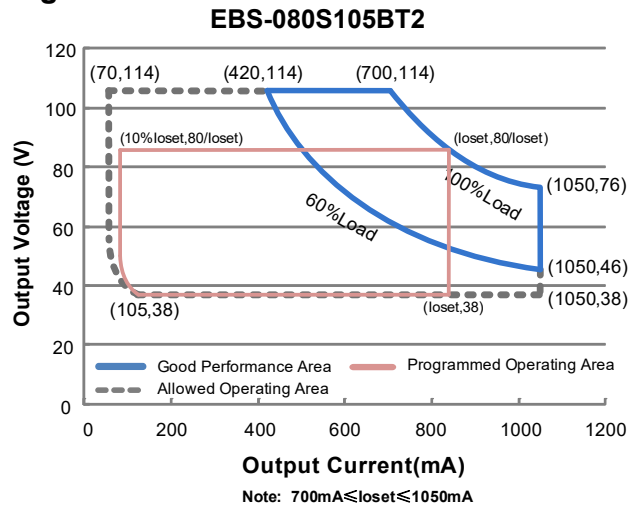
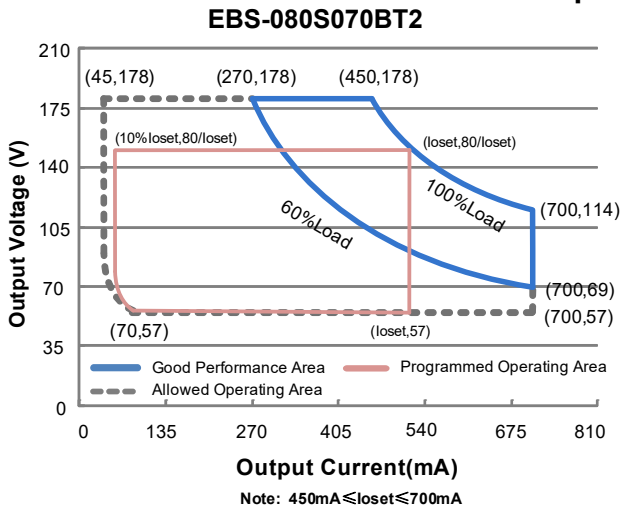

Input Specifications

Parameter	Min.	Typ.	Max.	Notes
Input AC Voltage	176 Vac	-	305 Vac	
Input DC Voltage	171 Vdc	-	275 Vdc	
Input Frequency	47 Hz	-	63 Hz	
Leakage Current	-	-	0.70 mA	IEC60598-1; 240Vac/60Hz
Input AC Current	-	-	0.44 A	Measured at 100% load and 220 Vac input.
Inrush Current(I ² t)	-	-	1.84 A ² s	At 220Vac input, 25°C Cold Start, Duration =256 μs, 10%Ipk-10%Ipk. See Inrush Current Waveform for the details.
PF	0.90	-	-	At 200-240Vac, 50-60Hz, 60%-100% load (48-80W)

Input Specifications (Continued)

Parameter	Min.	Typ.	Max.	Notes
THD	-	-	20%	At 200-240Vac, 50-60Hz, 60%-100% load (48-80W)
THD	-	-	10%	At 220-240Vac, 50-60Hz, 70%-100% load (56-80W)

Output Specifications

Parameter	Min.	Typ.	Max.	Notes
Output Current Tolerance	-5%loset	-	5%loset	At 100% load condition
Output Current Setting(loset) Range				
EBS-080S070BT2	45 mA	-	700 mA	
EBS-080S105BT2	70 mA	-	1050 mA	
EBS-080S150BT2	105 mA	-	1500 mA	
Output Current Setting Range with Constant Power				
EBS-080S070BT2	450 mA	-	700 mA	
EBS-080S105BT2	700 mA	-	1050 mA	
EBS-080S150BT2	1050 mA	-	1500 mA	
Total Output Current Ripple (pk-pk)	-	5%lomax	10%lomax	At 100% load condition, 20 MHz BW
Output Current Ripple at < 200 Hz (pk-pk)	-	2%lomax	-	At 100% load condition. Only this component of ripple is associated with visible flicker.
Startup Overshoot Current	-	-	10%lomax	At 100% load condition
No Load Output Voltage				
EBS-080S070BT2	-	-	210 V	
EBS-080S105BT2	-	-	120 V	
EBS-080S150BT2	-	-	90 V	
Line Regulation	-	-	±0.5%	Measured at 100% load
Load Regulation	-	-	±3.0%	
Turn-on Delay Time	-	-	0.5 s	Measured at all dimming modes except DALI-2, and 220Vac input, 60%-100% load
	-	-	1.0 s	Measured at DALI-2 dimming mode, and 220Vac input, 60%-100% load
Temperature Coefficient of loset	-	0.03%/°C	-	Case temperature = 0°C~Tc max
24V Auxiliary Output Voltage	21.6 V	24 V	26.4 V	
24V Auxiliary Output Source Current	0 mA	-	125 mA	Return terminal is "DA-"
24V Auxiliary Output Transient Peak Current @ 6W	-	-	250 mA	250mA peak for a maximum duration of 2.2 ms in a 6.0ms period during which time the average should not exceed 125mA.
24V Auxiliary Output Transient Peak Current @ 10W	-	-	425 mA	425mA peak for a maximum duration of 1.3 ms in a 5.2ms period during which time the average should not exceed 125mA.
Integrated DALI-2 Bus Power Supply Voltage	12 Vdc	16 Vdc	20 Vdc	Voltage is depending on loading.
Integrated DALI-2 Bus Power Supply Current	50 mA	-	60 mA	Return terminal is "DA-"

Notes: (1) DALI-2 bus power supply is enabled by default and can be disabled via programming interface.

(2) DALI-2 bus power supply supports automatic shut-down and restart after short-circuit.

General Specifications

Parameter	Min.	Typ.	Max.	Notes
Efficiency at 220 Vac input: EBS-080S070BT2 I _o = 450 mA I _o = 700 mA EBS-080S105BT2 I _o = 700 mA I _o =1050 mA EBS-080S150BT2 I _o =1050 mA I _o =1500 mA	90.5% 90.5% 89.5% 90.5% 89.5% 90.0%	92.5% 92.5% 91.5% 92.5% 91.5% 92.0%	- - - - - -	Measured at 100% load and steady-state temperature in 25°C ambient; (Efficiency will be about 2.0% lower if measured immediately after startup.)
Power Monitoring Accuracy	-1%	-	1%	Measured at 220Vac input and 100% load
Standby Power	-	-	0.5 W	Measured at 230Vac/50Hz; Dimming off
MTBF	-	203,000 Hours	-	Measured at 220Vac input, 80%load and 25°C ambient temperature (MIL-HDBK-217F)
Lifetime	-	100,000 Hours	-	Measured at 220Vac input, 80%load and 75°C case temperature; See lifetime vs. T _c curve for the details
Operating Case Temperature for Safety T _{c_s}	-40°C	-	+90°C	
Operating Case Temperature for Warranty T _{c_w}	-40°C	-	+75°C	Case temperature for 8 years warranty. Please see Inventronics Warranty Statement for complete details. Humidity: 10% RH to 90% RH; No condensation
Storage Temperature	-40°C	-	+85°C	Humidity: 5% RH to 95% RH; No condensation
Dimensions Inches (L × W × H) Millimeters (L × W ×H)	5.24 x 3.03 x 1.42 133 x 77 x 36			
Net Weight	-	330 g	-	

Dimming Specifications

Parameter	Min.	Typ.	Max.	Notes
DALI-2	DA+, DA- High Level	9.5 V	16 V	22.5 V
	DA+, DA- Low Level	-6.5 V	0 V	6.5 V
	DA+, DA- Current	0 mA	-	2 mA

Dimming Specifications (Continued)

Parameter		Min.	Typ.	Max.	Notes
AC Dim	Start Input Voltage	180 Vac	-	250 Vac	Default is 220 Vac
	Start Output Level	30%	-	100%	Default is 100%
	Stop Input Voltage	160 Vac	-	230 Vac	Default is 170 Vac
	Stop Output Level	30%	-	85%	Default is 30%
	Gap between Start and Stop Input Voltage	20 Vac	-	-	
	Increment of Start and Stop Input Voltage	-	1 Vac	-	
	Increment of Start and Stop Output Level	-	1%	-	
Dimming Output Range	EBS-080S070BT2 EBS-080S105BT2 EBS-080S150BT2	10%loset	-	loset	450 mA ≤ loset ≤ 700 mA 700 mA ≤ loset ≤ 1050 mA 1050 mA ≤ loset ≤ 1500 mA
	EBS-080S070BT2 EBS-080S105BT2 EBS-080S150BT2	45 mA 70 mA 105 mA	-	loset	45 mA ≤ loset < 450 mA 70 mA ≤ loset < 700 mA 105 mA ≤ loset < 1050 mA

Safety & EMC Compliance

Safety Category	Standard
ENEC	EN 61347-1, EN 61347-2-13
CE	EN 61347-1, EN 61347-2-13 EN 301 489-1 V2.2.3 EN 301 489-3 V2.1.1 EN 300 330 V2.1.1 EN 62479/EN 50663/EN 50665/EN 50364
CB	IEC 61347-1, IEC 61347-2-13
CCC	GB 19510.1, GB 19510.14
BIS	IS 15885(Part2/Sec13)
KS	KS C 7655
Performance	Standard
ENEC	EN 62384
EMI Standards	Notes
EN 55015/GB 17743 ⁽¹⁾	Conducted emission Test & Radiated emission Test
EN 61000-3-2/GB 17625.1	Harmonic current emissions Class C
EN 61000-3-3	Voltage Fluctuations & Flicker
EMS Standards	Notes
EN 61000-4-2	Electrostatic Discharge(ESD): 8 kV air discharge, 4 kV contact discharge
EN 61000-4-3	Radio-Frequency Electromagnetic Field Susceptibility Test-RS

Safety & EMC Compliance (Continued)

EMS Standards	Notes
EN 61000-4-4	Electrical Fast Transient/Burst-EFT
EN 61000-4-5	Surge Immunity Test: AC Power Line: Differential Mode 6 kV, Common Mode 8 kV
EN 61000-4-6	Conducted Radio Frequency Disturbances Test-CS
EN 61000-4-8	Power Frequency Magnetic Field Test
EN 61000-4-11	Voltage Dips
EN 61547	Surge Immunity Test: AC Power Line: Differential Mode 6 kV, Common Mode 10 kV
	Electromagnetic Immunity Requirements Applies to Lighting Equipment
DALI-2 Standards	Notes
DALI-2 ⁽²⁾	IEC 62386-101, -102 & -207

Notes: (1) This LED driver meets the EMI specifications above, but EMI performance of a luminaire that contains it depends also on the other devices connected to the driver and on the fixture itself.
 (2) DALI parts: 101, 102, 150, 207, 250, 251, 252, 253.

Lifetime vs. Case Temperature

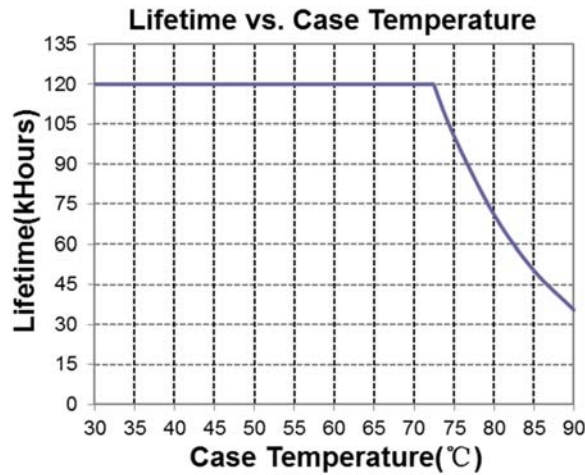

Inrush Current Waveform

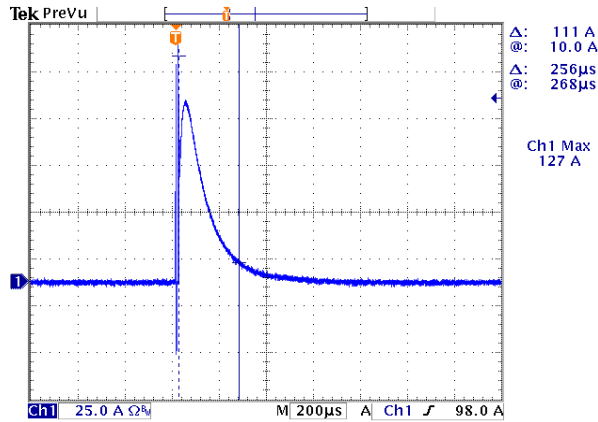

Efficiency vs. Load

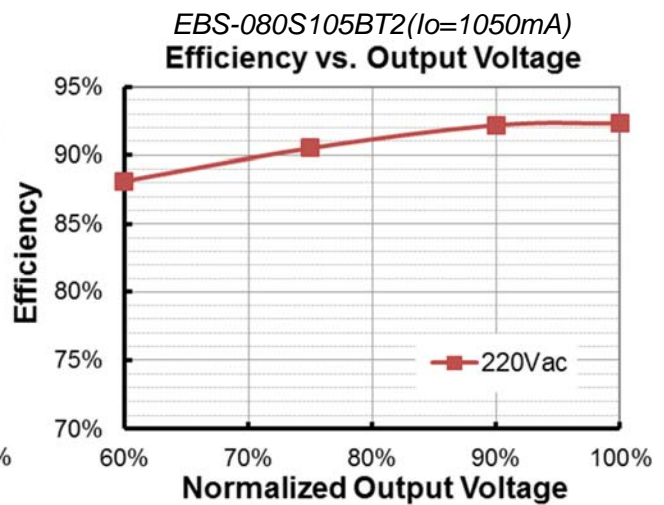
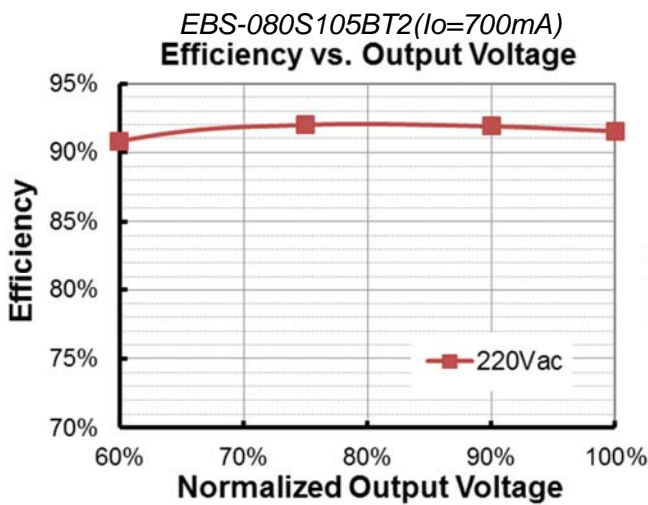
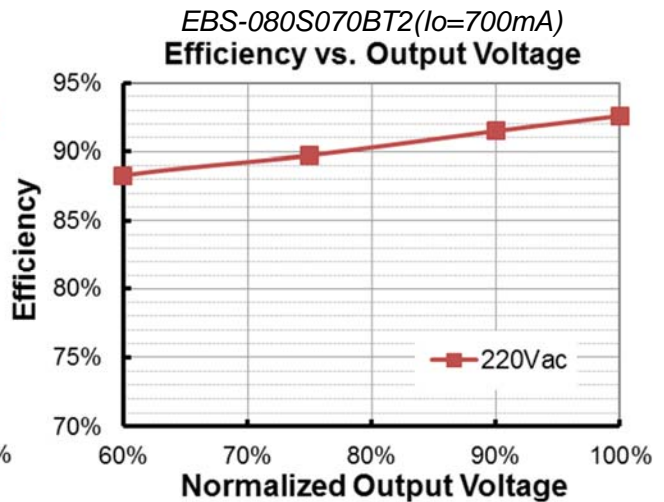
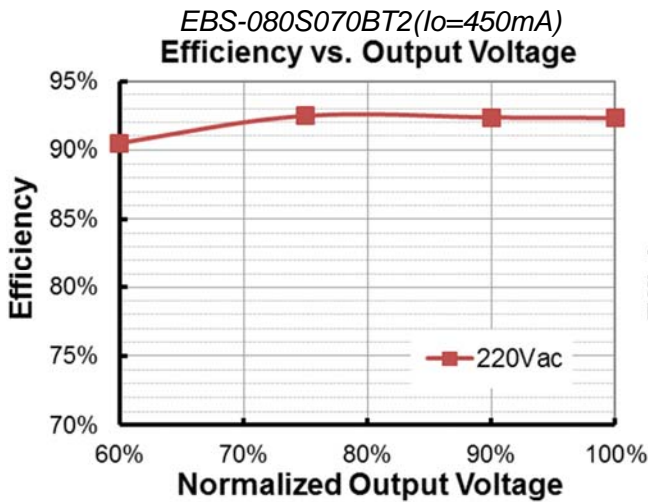

EBS-080S150BT2 (Io=1050mA)
Efficiency vs. Output Voltage

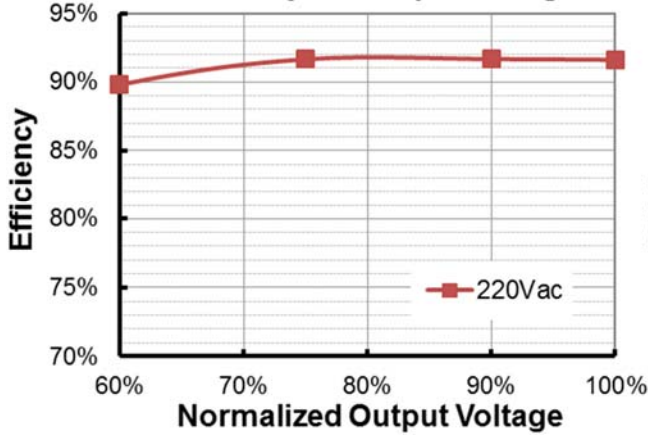

EBS-080S150BT2 (Io=1500mA)
Efficiency vs. Output Voltage

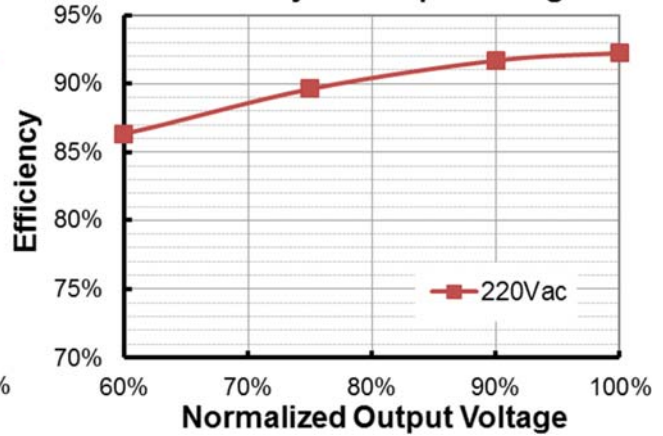

Power Factor

PF vs. Load

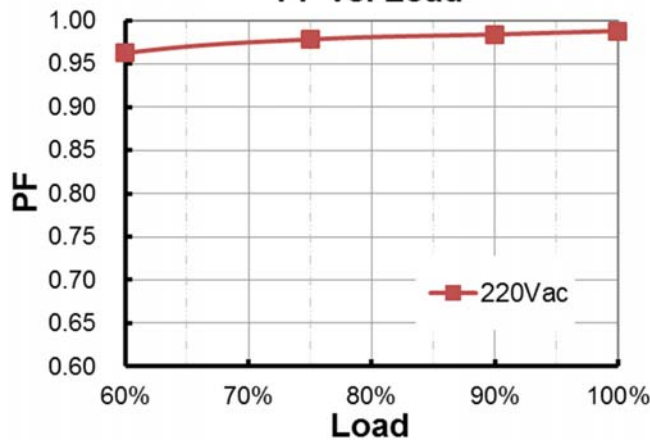

Total Harmonic Distortion

THD vs. Load

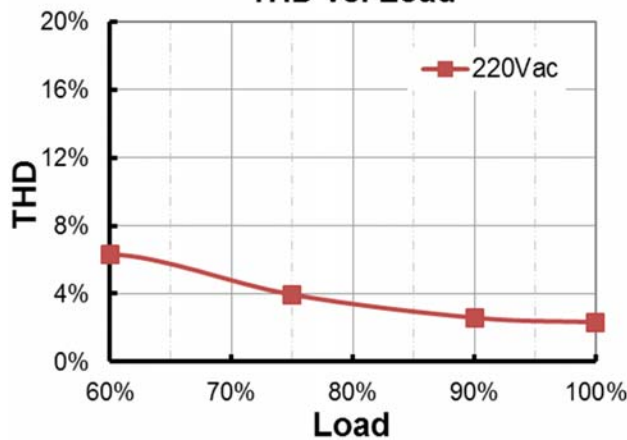

Protection Functions

Parameter		Min.	Typ.	Max.	Notes
External Thermal Protection	R1 (Start derating)	-	1.67 kΩ	-	The output current starts to decrease linearly when the actual NTC resistance value is lower than R1, until R2 is reached.
	R2 (Stop derating)	-	1.27 kΩ	-	When the actual NTC resistance value is lower than R2, the output current will stay at the programmed Protection Current Floor.
	Protection Current Floor	10%loset	20%loset	100%loset	10%loset > I _{omin} (default setting is 20%)
I _{omin}		20%loset	100%loset	10%loset ≤ I _{omin} (default setting is 20%)	
Over Voltage Protection		Limits output voltage at no load and in case the normal voltage limit fails.			
Short Circuit Protection		Auto Recovery. No damage will occur when any output is short circuited. The output shall return to normal when the fault condition is removed.			
Over Temperature Protection		Decreases output current, returning to normal after over temperature is removed.			
Input Under Voltage Protection (IUVP)	Input Under Voltage Protection	140 Vac	150 Vac	160 Vac	Turn off the output when the input voltage falls below protection voltage.
	Input Under Voltage Recovery	150 Vac	160 Vac	170 Vac	Auto Recovery. The driver will restart when the input voltage exceeds recovery voltage.
Input Over Voltage Protection (IOVP)	Input Over Voltage Protection	310 Vac	320 Vac	330 Vac	Turn off the output when the input voltage exceeds protection voltage.
	Input Over Voltage Recovery	300 Vac	310 Vac	320 Vac	Auto Recovery. The driver will restart when the input voltage falls below recovery voltage.
	Max. of Input Over Voltage	-	-	350 Vac	The driver can survive stabilized input over voltage conditions up to 350Vac for a total of 8 hours.

Note: (1) The recommended NTC type is 10kΩ NTC, Murata NCP18XH103J03RB.

● Input Under Voltage Protection Diagram

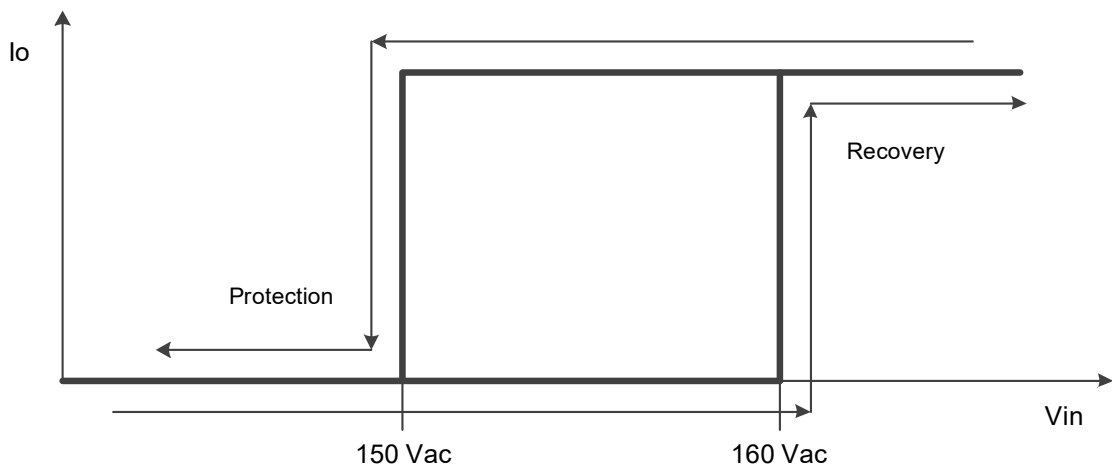

● **Input Over Voltage Protection Diagram**

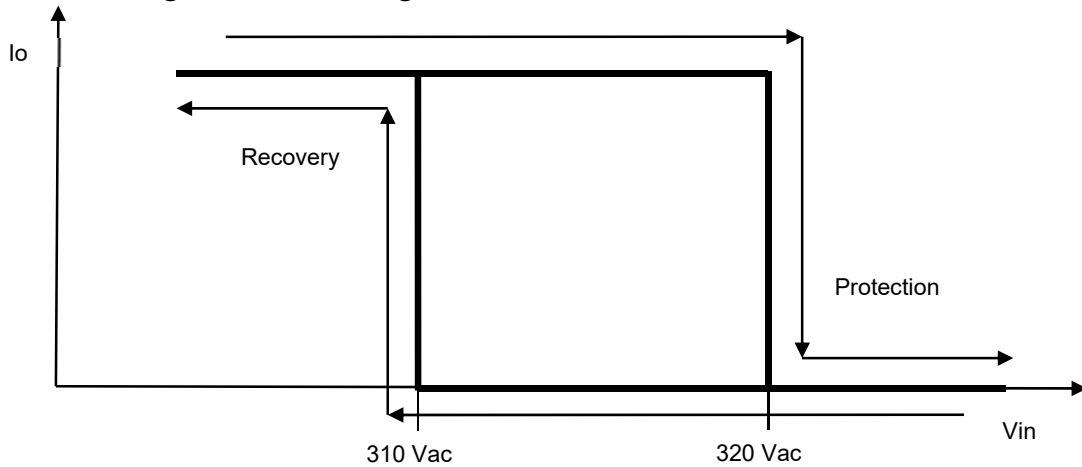

Dimming

● **DALI-2 Dimming**

The recommended implementation of the dimming control is provided below.

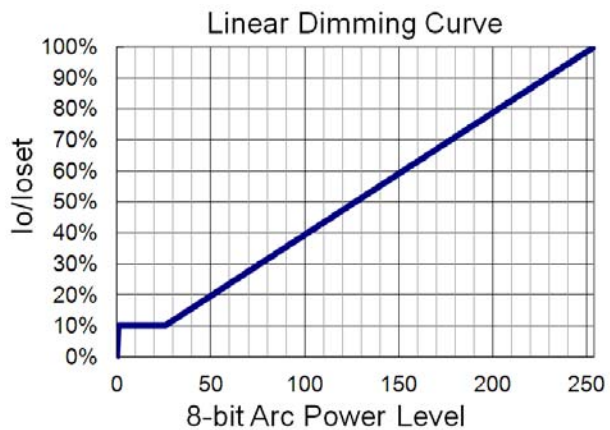
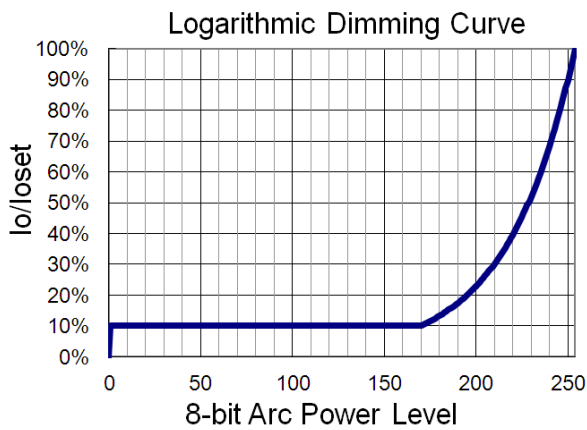
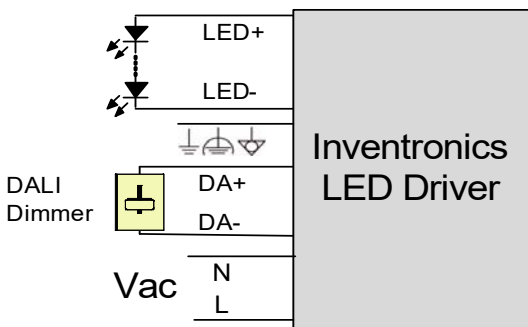

Implementation 1: DALI-2 Dimming

● **Time Dimming**

Time dimming control includes 3 kinds of modes, they are Self Adapting-Midnight, Self Adapting-Percentage and Traditional Timer.

- **Self Adapting-Midnight:** Automatically adjusts the dimming curve based on the on-time of past two days (if difference <15 minutes), assuming that the center point of the dimming curve is midnight local time.
- **Self Adapting-Percentage:** Automatically adjusts the on-time of each step by a constant percentage = (actual on-time for the past 2 days if difference <15 min) / (programmed on-time from the dimming curve).
- **Traditional Timer:** Follows the programmed timing curve after power on with no changes.

● **AC Dimming**

The default range of AC Dim is 160-250Vac. The range can be adjusted via the programming interface. Also, the Start Input Voltage, Start Output Level, Stop Input Voltage and Stop Output Level can be set. There needs to be a minimum of 20V difference between Start and Stop Input Voltage settings when programming the driver.

There must be a minimum voltage difference of 5V from the Start Input Voltage before the driver starts dimming.

Output Level

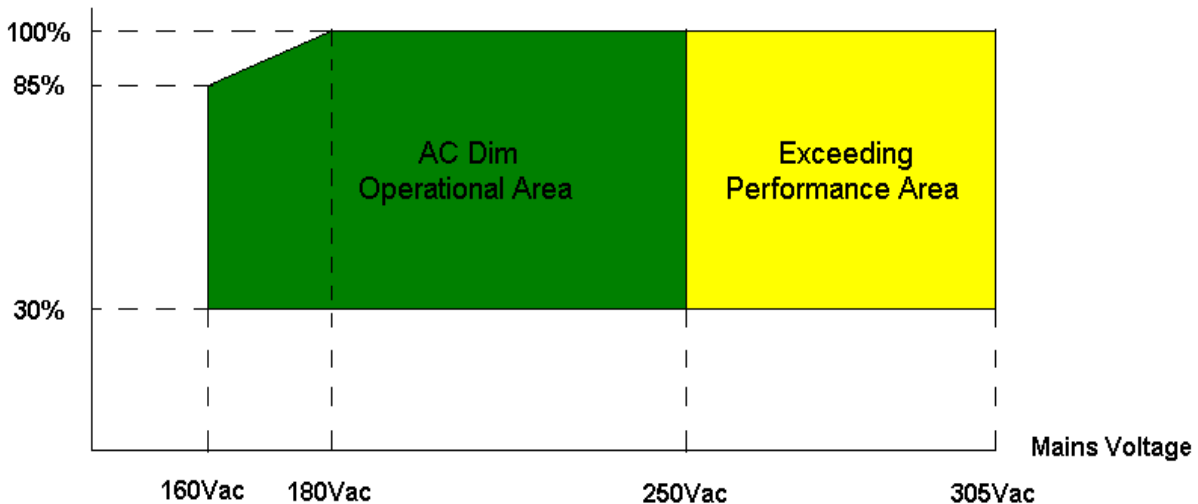

Notes:

1. In the green area, the driver will operate normally.
2. In the yellow area, the driver will operate safely but not fulfill requirements.

● **Output Lumen Compensation**

Output Lumen Compensation (OLC) may be used to maintain constant light output over the life of the LEDs by driving them at a reduced current when new, then gradually increasing the drive current over time to counteract LED lumen degradation.

● **End Of Life**

End-of-Life (EOL) is providing a visual notification to a user that the LED module has reached the end of manufacturer-specified life and that the replacement is recommended. Once active, an indication is given at each power-up of the driver, which the driver indicates this through a lower light output during the first 1 minute before normal operation is continued.

Wire Connection Diagram

Parameter		Min.	Typ.	Max.	Notes
L, N, 	Wire Cross-section	0.4 mm ²	-	1.5 mm ²	Push-in at 45° angle, solid and stranded wire
		20 AWG	-	16 AWG	
	Strip Length	8.5 mm	-	9.5 mm	
LED+, LED-, NTC-, NTC+, +24V, DA+, DA-	Wire Cross-section	0.2 mm ²	-	1.5 mm ²	Push-in at 45° angle, solid and stranded wire
		22 AWG	-	16 AWG	
	Strip Length	8.5 mm	-	9.5 mm	

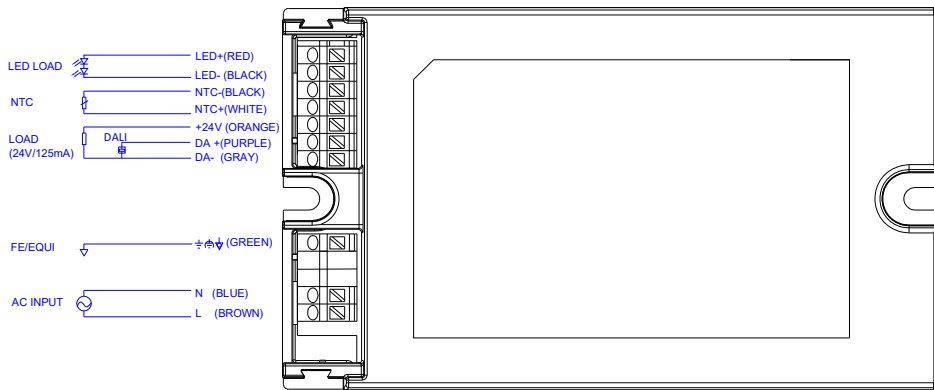

Programming Connection Diagram

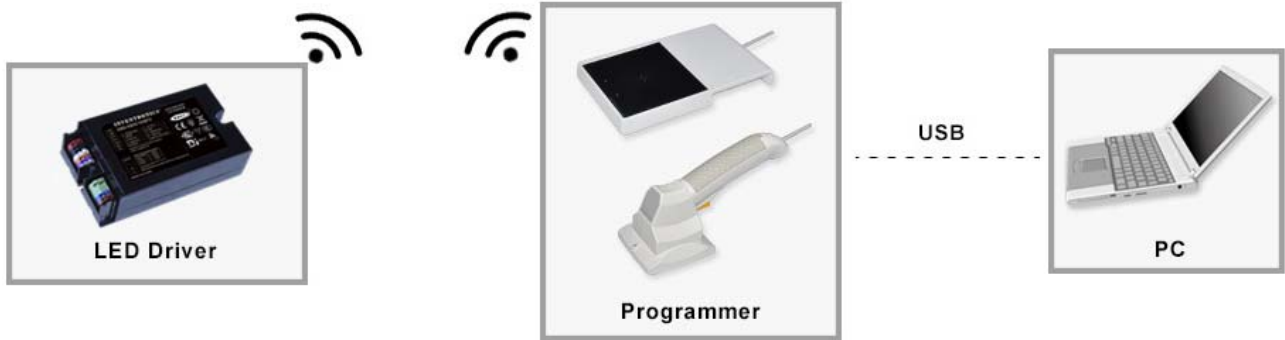

Note: The driver does not need to be powered on during the programming process.

- Please refer to [PRG-NFC-H](#) or [PRG-NFC-D](#) (Programmer) datasheet for details.

Mechanical Outline

EBS-080SxxxBT2

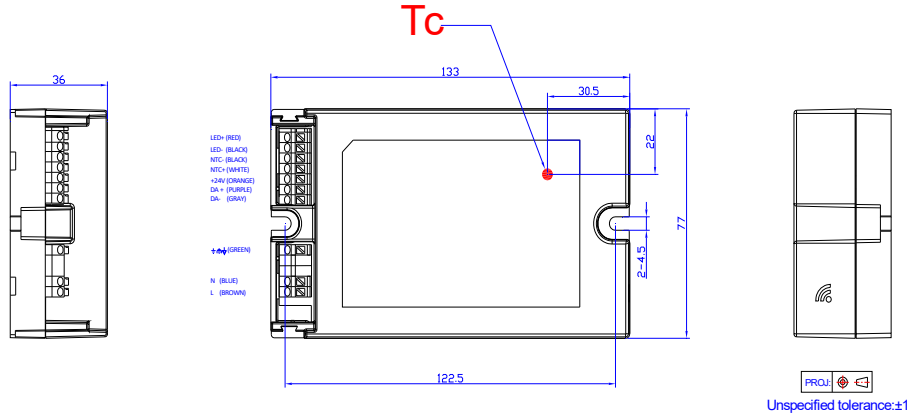

Optional Cable Clamp

END-CAP02

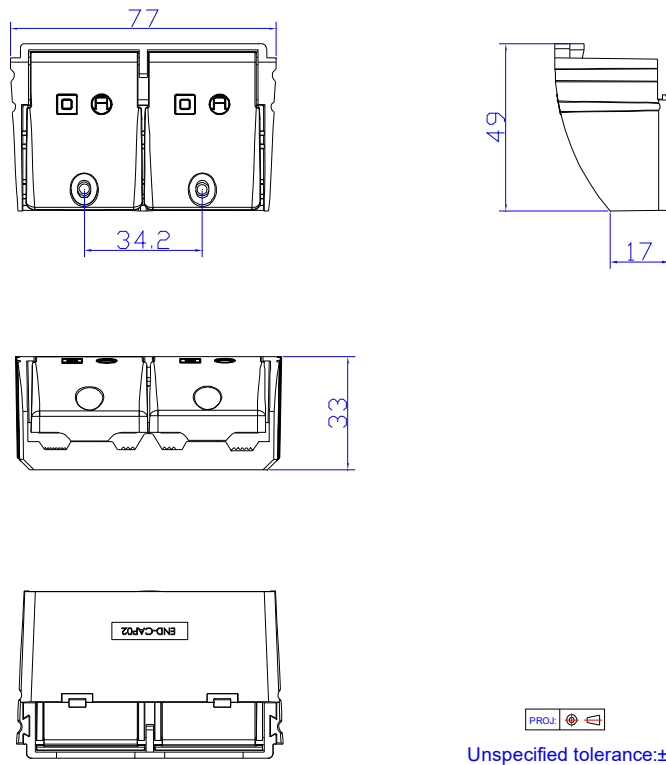

Note: The cable clamp is to be installed with EBS-080SxxxBT2 drivers for independent application. Please refer to [END-CAP02](#) datasheet for details.

RoHS Compliance

Our products comply with reference to RoHS Directive (EU) 2015/863 amending 2011/65/EU, calling for the elimination of lead and other hazardous substances from electronic products.

Revision History

Change Date	Rev.	Description of Change		
		Item	From	To
2020-07-22	A	Datasheet Release	/	/
2020-11-30	B	ENEC Logo	/	Updated
		BIS Logo	/	Added
		Models	Notes: (2)	Updated
		Models	Notes: (5)	Updated
		Safety &EMC Compliance	CE	Updated
		Safety &EMC Compliance	BIS	Added
		Safety &EMC Compliance	EMI Standards	Updated
2021-09-17	C	Safety &EMC Compliance	CE	Updated
		Safety &EMC Compliance	Performance	Added