

Features

- Full Power at Wide Output Current Range (Constant Power)
- Adjustable Output Current (AOC) with NFC
- DALI-2 and D4i Certified
- AC Dim/3-Timer-Modes Dimmable
- Dim-to-Off with Standby Power ≤ 0.5 W
- Always-on Auxiliary Power:
24Vdc, 125mA, 3W (Transient Peak Power up to 10W)
- Integrated 16Vdc Bus Power Supply Based on DALI-2
- Integrated Power Monitoring with High Accuracy up to $\pm 1\%$
- Output Lumen Compensation
- End-of-Life Indicator
- Thermal Sensing and Protection for LED Module
- Long Lifetime Over 100K Hours at 75°C Case Temperature
- Input Surge Protection: DM 6kV, CM 10kV
- All-Around Protection: IUVP, IOVP, OVP, SCP, OTP
- IP20 Design and Suitable for Outdoor Applications in Luminaires with IP>54
- Suitable for Luminaires with Protection Class I and II
- Complies with Zhaga Interface Specification Book 13
- 8 Year Warranty



Description

The EBS-040SxxxBT2 series is a 40W, constant-current, NFC programmable and IP20 rated LED driver that operates from 176-305 Vac input with excellent power factor. Created for many lighting applications including street, tunnel and low bay, etc., this family provides integrated AC power monitoring with an auxiliary voltage and dim-to-off functionality for powering low voltage, wireless controls. The dimming control supports two-way communication via DALI-2 and complies with D4i. The high efficiency of these drivers and better thermal design enable them to run cooler, significantly improving reliability and extending product life. To ensure trouble-free operation, protection is provided against input surge, input under voltage, input over voltage, output over voltage, short circuit, and over temperature of both the driver and the external LED array.

Models

| Adjustable Output Current Range | Full-Power Current Range(1) | Default Output Current | Input Voltage Range(2) | Output Voltage Range | Max. Output Power | Typical Efficiency (3) | Typical Power Factor (3) | Model Number (4) |
|---------------------------------|-----------------------------|------------------------|----------------------------|----------------------|-------------------|------------------------|--------------------------|-------------------------------|
| 30-450 mA | 300-450 mA | 450 mA | 176~305 Vac 171~275 Vdc | 44~133 Vdc | 40 W | 90.5% | 0.96 | EBS-040S045BT2 |
| 45-700 mA | 450-700 mA | 700 mA | 176~305 Vac 171~275 Vdc | 28~89 Vdc | 40 W | 90.5% | 0.96 | EBS-040S070BT2 ⁽⁵⁾ |
| 70-1050mA | 700-1050 mA | 1050 mA | 176~305 Vac 171~275 Vdc | 19 ~57 Vdc | 40 W | 89.5% | 0.96 | EBS-040S105BT2 ⁽⁵⁾ |

- Notes:** (1) Output current range with constant power at 40W.
 (2) Certified input voltage range: 200-240Vac.
 (3) Measured at 100% load and 220Vac input (see below "General Specifications" for details).
 (4) All the models are certificated to BIS, except EBS-040S045BT2.
 (5) SELV output.

I-V Operating Area

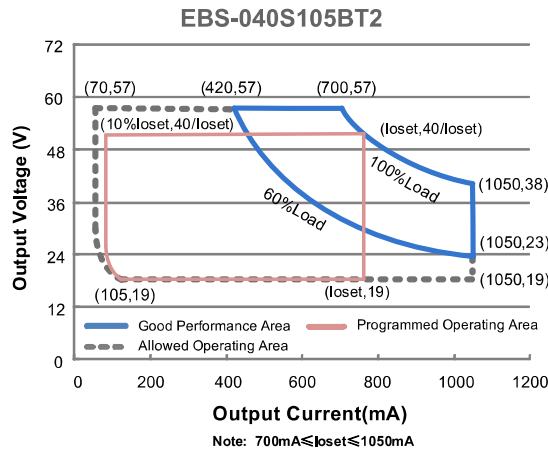
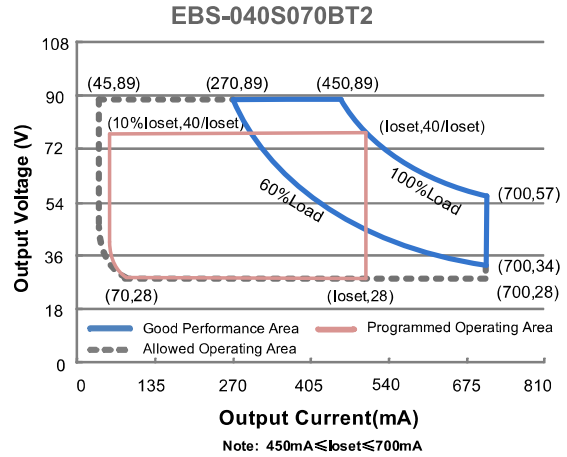
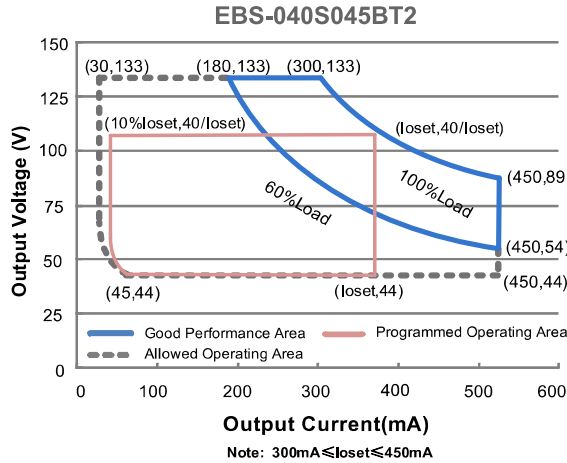

Input Specifications

| Parameter | Min. | Typ. | Max. | Notes |
|--------------------------|---------|------|-----------------------|--|
| Input AC Voltage | 176 Vac | - | 305 Vac | |
| Input DC Voltage | 171 Vdc | - | 275 Vdc | |
| Input Frequency | 47 Hz | - | 63 Hz | |
| Leakage Current | - | - | 0.70 mA | IEC 60598-1; 240Vac/60Hz |
| Input AC Current | - | - | 0.22 A | Measured at 100% load and 220 Vac input. |
| Inrush Current(I^2t) | - | - | 1.57 A ² s | At 220Vac input, 25°C Cold Start, Duration =728 μ s, 10%Ipk-10%Ipk. See Inrush Current Waveform for the details. |
| PF | 0.90 | - | - | At 200-240Vac, 50-60Hz, 60%-100% Load (24-40W) |
| THD | - | - | 20% | |

Input Specifications (Continued)

| Parameter | Min. | Typ. | Max. | Notes |
|-----------|------|------|------|--|
| THD | - | - | 10% | At 220-240Vac, 50-60Hz, 70%-100% Load (28-40W) |

Output Specifications

| Parameter | Min. | Typ. | Max. | Notes |
|---|----------|----------|----------|--|
| Output Current Tolerance | -5%loset | - | 5%loset | At 100% load condition |
| Output Current Setting(loset) Range | | | | |
| EBS-040S045BT2 | 30 mA | - | 450 mA | |
| EBS-040S070BT2 | 45 mA | - | 700 mA | |
| EBS-040S105BT2 | 70 mA | - | 1050 mA | |
| Output Current Setting Range with Constant Power | | | | |
| EBS-040S045BT2 | 300 mA | - | 450 mA | |
| EBS-040S070BT2 | 450 mA | - | 700 mA | |
| EBS-040S105BT2 | 700 mA | - | 1050 mA | |
| Total Output Current Ripple (pk-pk) | - | 5%Iomax | 10%Iomax | At 100% load condition, 20 MHz BW |
| Output Current Ripple at < 200 Hz (pk-pk) | - | 2%Iomax | - | At 100% load condition. Only this component of ripple is associated with visible flicker. |
| Startup Overshoot Current | - | - | 10%Iomax | At 100% load condition |
| No Load Output Voltage | | | | |
| EBS-040S045BT2 | - | - | 170 V | |
| EBS-040S070BT2 | - | - | 115 V | |
| EBS-040S105BT2 | - | - | 75 V | |
| Line Regulation | - | - | ±1% | Measured at 100% load |
| Load Regulation | - | - | ±5% | |
| Turn-on Delay Time | - | - | 0.5 s | Measured at all dimming modes except DALI-2, and 220Vac input, 60%-100% Load |
| | - | - | 1.0 s | Measured at DALI-2 dimming mode, and 220Vac input, 60%-100% Load |
| Temperature Coefficient of loset | - | 0.06%/°C | - | Case temperature = 0°C ~Tc max |
| 24V Auxiliary Output Voltage | 21.6 V | 24 V | 26.4 V | |
| 24V Auxiliary Output Source Current | 0 mA | - | 125 mA | Return terminal is "DA-" |
| 24V Auxiliary Output Transient Peak Current @6W | - | - | 250 mA | 250mA peak for a maximum duration of 2.2 ms in a 6.0ms period during which time the average should not exceed 125mA. |
| 24V Auxiliary Output Transient Peak Current @10W | - | - | 425 mA | 425mA peak for a maximum duration of 1.3 ms in a 5.2ms period during which time the average should not exceed 125mA. |
| Integrated DALI-2 Bus Power Supply Voltage | 12 Vdc | 16 Vdc | 20 Vdc | Voltage is depending on loading. |
| Integrated DALI-2 Bus Power Maximum Supply Current | 60 mA | | | |
| Integrated DALI-2 Bus Power Guaranteed Supply Current | 50 mA | | | DALI-2 Bus Power Supply Voltage ≥12V |

Notes: (1) DALI-2 bus power supply is enabled by default and can be disabled via programming interface.
 (2) DALI-2 bus power supply supports automatic shut-down and restart after short-circuit.

General Specifications

| Parameter | Min. | Typ. | Max. | Notes |
|--|-------------------------------------|---------------|-------|--|
| Efficiency at 220 Vac input: EBS-040S045BT2 | | | | |
| I _o = 300 mA | 88.5% | 90.5% | - | |
| I _o = 450 mA | 88.5% | 90.5% | - | Measured at 100% load and steady-state temperature in 25°C ambient; (Efficiency will be about 2.0% lower if measured immediately after startup.) |
| EBS-040S070BT2 | | | | |
| I _o = 450 mA | 88.5% | 90.5% | - | |
| I _o = 700 mA | 88.0% | 90.0% | - | |
| EBS-040S105BT2 | | | | |
| I _o = 700 mA | 87.5% | 89.5% | - | |
| I _o = 1050 mA | 87.0% | 89.0% | - | |
| Power Monitoring Accuracy | -1% | - | 1% | Measured at 220Vac input and 100% load |
| Standby Power | - | - | 0.5 W | Measured at 230Vac/50Hz; Dimming off |
| MTBF | - | 206,000 hours | - | Measured at 220Vac input, 80% Load and 25°C ambient temperature (MIL-HDBK-217F) |
| Lifetime | - | 110,000 hours | - | Measured at 220Vac input, 80%Load and 75°C case temperature; See lifetime vs. T _c curve for the details |
| Operating Case Temperature for Safety T _{c_s} | -40°C | - | +90°C | |
| Operating Case Temperature for Warranty T _{c_w} | -40°C | - | +75°C | Case temperature for 8 years warranty. Please see Inventronics Warranty Statement for complete details. Humidity: 10% RH to 90% RH No condensation |
| Storage Temperature | -40°C | - | +85°C | Humidity: 5% RH to 95% RH No condensation |
| Dimensions Inches (L × W × H) Millimeters (L × W ×H) | 5.24 x 3.03 x 1.30 133 x 77 x 33 | | | |
| Net Weight | - | 250 g | - | |

Dimming Specifications

| Parameter | Min. | Typ. | Max. | Notes |
|-----------|---------------------|--------|------|--------|
| DALI-2 | DA+, DA- High Level | 9.5 V | 16 V | 22.5 V |
| | DA+, DA- Low Level | -6.5 V | 0 V | 6.5 V |
| | DA+, DA- Current | 0 mA | - | 2 mA |

Dimming Specifications (Continued)

| Parameter | | Min. | Typ. | Max. | Notes |
|----------------------|--|-------------------------|-------|-------------------|--|
| AC Dim | Start Input Voltage | 180 Vac | - | 250 Vac | Default is 220 Vac |
| | Start Output Level | 30% | - | 100% | Default is 100% |
| | Stop Input Voltage | 160 Vac | - | 230 Vac | Default is 170 Vac |
| | Stop Output Level | 30% | - | 85% | Default is 30% |
| | Gap between Start and Stop Input Voltage | 20 Vac | - | - | |
| | Increment of Start and Stop Input Voltage | - | 1 Vac | - | |
| | Increment of Start and Stop Output Level | - | 1% | - | |
| Dimming Output Range | EBS-040S045BT2 EBS-040S070BT2 EBS-040S105BT2 | 10%I _{oSet} | - | I _{oSet} | 300 mA ≤ I _{oSet} ≤ 450 mA 450 mA ≤ I _{oSet} ≤ 700 mA 700 mA ≤ I _{oSet} ≤ 1050 mA |
| | EBS-040S045BT2 EBS-040S070BT2 EBS-040S105BT2 | 30 mA 45 mA 70 mA | - | I _{oSet} | 30 mA ≤ I _{oSet} < 300 mA 45 mA ≤ I _{oSet} < 450 mA 70 mA ≤ I _{oSet} < 700 mA |

Safety & EMC Compliance

| Safety Category | Standard |
|-----------------------------|--|
| ENEC | EN 61347-1 ⁽¹⁾ , EN 61347-2-13 |
| CE | EN 61347-1 ⁽¹⁾ , EN 61347-2-13 EN 301 489-1 EN 301 489-3 EN 300 330 EN 62479/EN 50663/EN 50665/EN 50364 |
| CB | IEC 61347-1 ⁽¹⁾ , IEC 61347-2-13 |
| BIS | IS 15885(Part2/Sec13) |
| KS | KS C 7655 |
| Performance | Standard |
| ENEC | EN IEC 62384 |
| EMI Standards | Notes |
| EN IEC 55015 ⁽²⁾ | Conducted emission Test & Radiated emission Test |
| EN IEC 61000-3-2 | Harmonic current emissions Class C |
| EN 61000-3-3 | Voltage Fluctuations & Flicker |

Safety & EMC Compliance (Continued)

| EMS Standards | Notes |
|-----------------------|---|
| EN 61000-4-2 | Electrostatic Discharge(ESD): 8 kV air discharge, 4 kV contact discharge |
| EN 61000-4-3 | Radio-Frequency Electromagnetic Field Susceptibility Test-RS |
| EN 61000-4-4 | Electrical Fast Transient/Burst-EFT |
| EN 61000-4-5 | Surge Immunity Test: AC Power Line: Differential Mode 6 kV, Common Mode 8 kV |
| EN 61000-4-6 | Conducted Radio Frequency Disturbances Test-CS |
| EN 61000-4-8 | Power Frequency Magnetic Field Test |
| EN 61000-4-11 | Voltage Dips |
| EN 61547 | Surge Immunity Test: AC Power Line: Differential Mode 6 kV, Common Mode 10 kV |
| | Electromagnetic Immunity Requirements Applies to Lighting Equipment |
| DALI-2 Standards | Notes |
| DALI-2 ⁽³⁾ | IEC 62386-101, 102 & 207 |

Notes: (1) This product meets the requirements for EN/IEC 61347-1 [Annex O (Double insulation)].

(2) This LED driver meets the EMI specifications above, but EMI performance of a luminaire that contains it depends also on the other devices connected to the driver and on the fixture itself.

(3) DALI parts: 101, 102, 150, 207, 250, 251, 252, 253.

Lifetime vs. Case Temperature

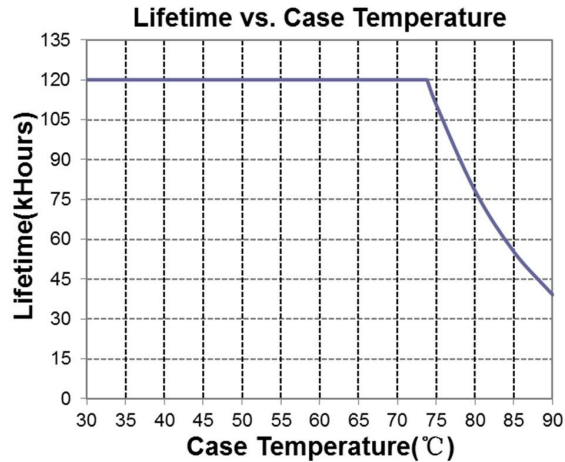

Inrush Current Waveform

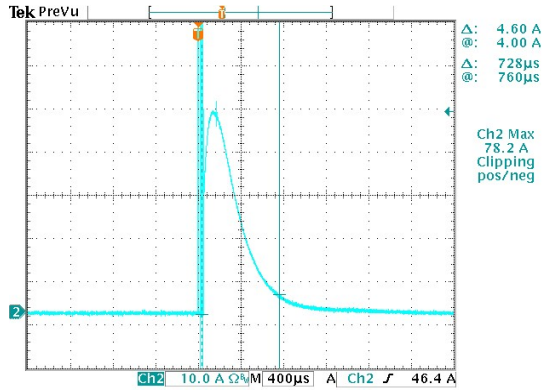

Efficiency vs. Load

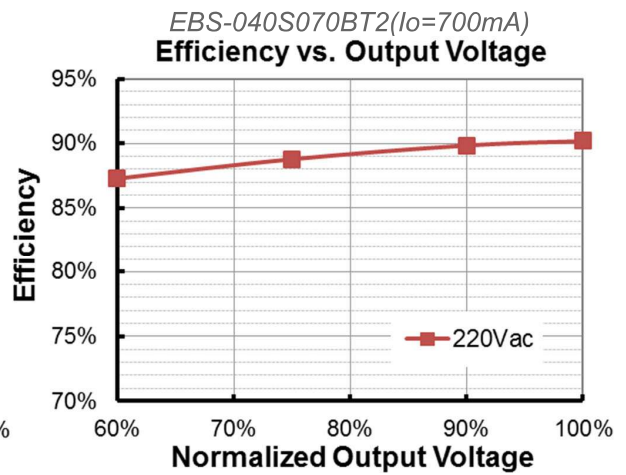
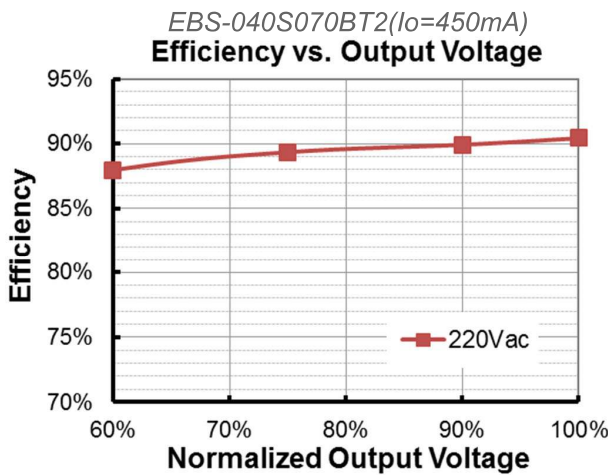
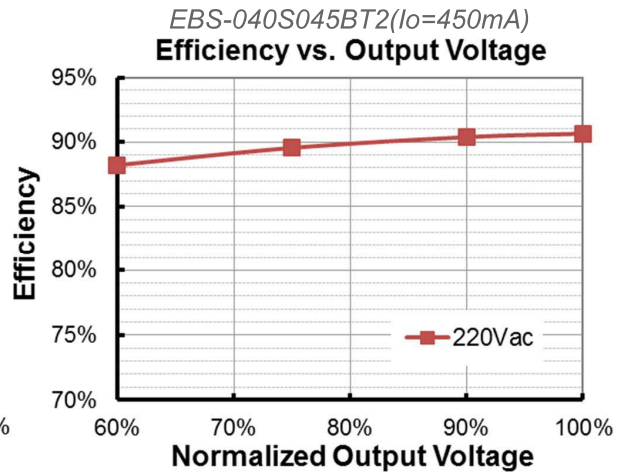
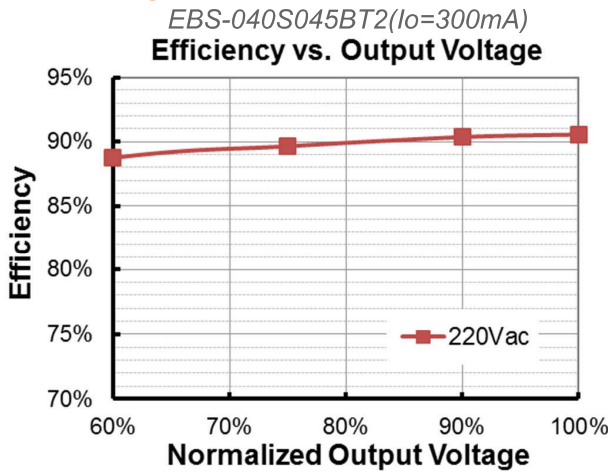

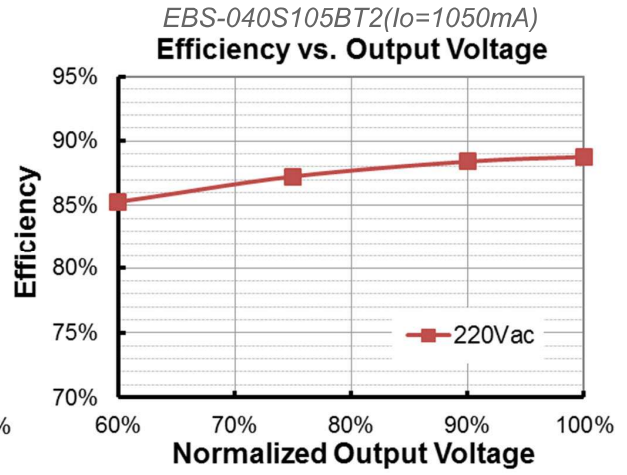
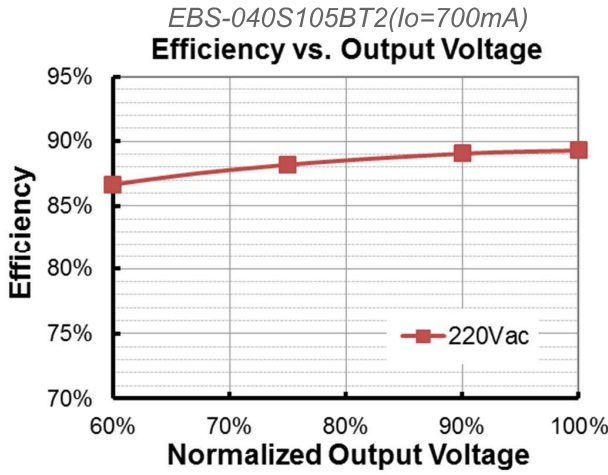

Power Factor

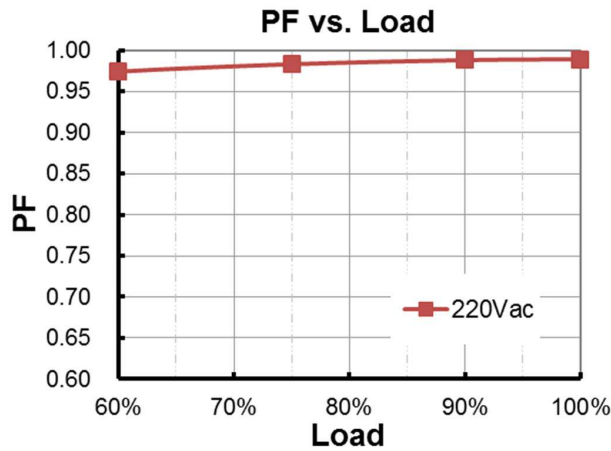

Total Harmonic Distortion

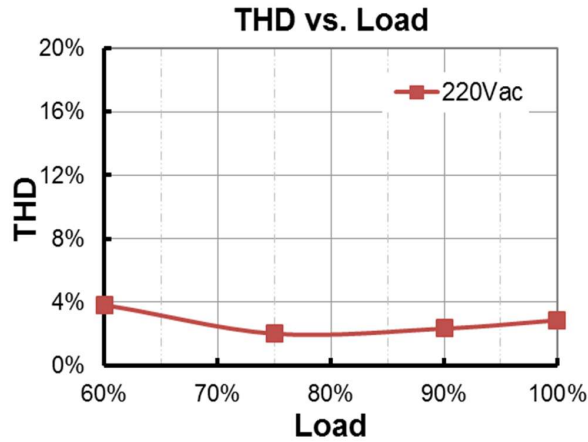

Protection Functions

| Parameter | | Min. | Typ. | Max. | Notes |
|---------------------------------------|----------------------------------|--|------------------------|---|---|
| External Thermal Protection | R1 (Start derating) | - | 1.67 kΩ | - | The output current starts to decrease linearly when the actual NTC resistance value is lower than R1, until R2 is reached. |
| | R2 (Stop derating) | - | 1.27 kΩ | - | When the actual NTC resistance value is lower than R2, the output current will stay at the programmed Protection Current Floor. |
| | Protection Current Setting Range | 10%I _o set | 20%I _o set | 100%I _o set | 10%I _o set > I _o min (default setting is 20%) |
| I _o min | | 20%I _o set | 100%I _o set | 10%I _o set ≤ I _o min (default setting is 20%) | |
| Over Voltage Protection | | Limits output voltage at no load and in case the normal voltage limit fails. | | | |
| Short Circuit Protection | | Auto Recovery. No damage will occur when any output is short circuited. The output shall return to normal when the fault condition is removed. | | | |
| Over Temperature Protection | | Decreases output current, returning to normal after over temperature is removed. | | | |
| Input Under Voltage Protection (IUVP) | Input Under Voltage Protection | 140 Vac | 150 Vac | 160 Vac | Turn off the output when the input voltage falls below protection voltage. |
| | Input Under Voltage Recovery | 150 Vac | 160 Vac | 170 Vac | Auto Recovery. The driver will restart when the input voltage exceeds recovery voltage. |
| Input Over Voltage Protection (IOVP) | Input Over Voltage Protection | 310 Vac | 320 Vac | 330 Vac | Turn off the output when the input voltage exceeds protection voltage. |
| | Input Over Voltage Recovery | 300 Vac | 310 Vac | 320 Vac | Auto Recovery. The driver will restart when the input voltage falls below recovery voltage. |
| | Max. of Input Over Voltage | - | - | 350 Vac | The driver can survive stabilized input over voltage conditions up to 350Vac for a total of 8 hours. |

Note: (1) The recommended NTC type is 10kΩ NTC, Murata NCP18XH103J03RB

● Input Under Voltage Protection Diagram

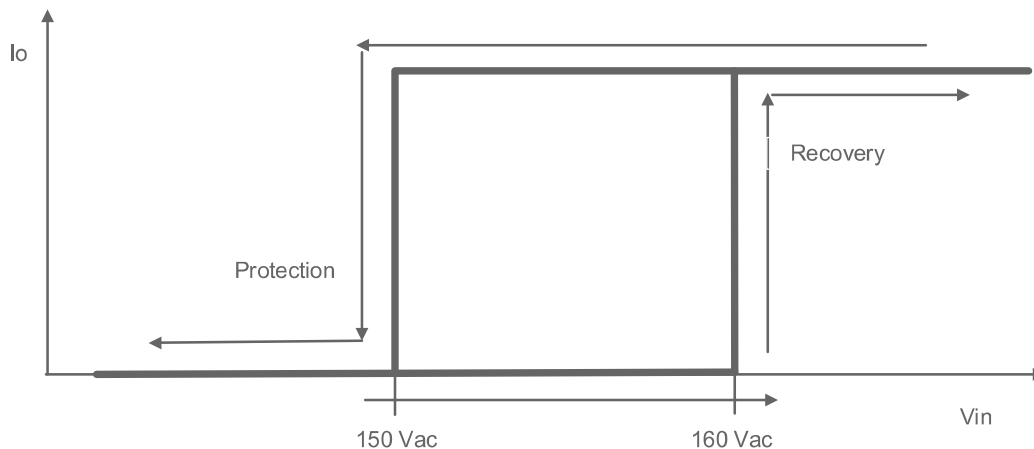

● Input Over Voltage Protection Diagram

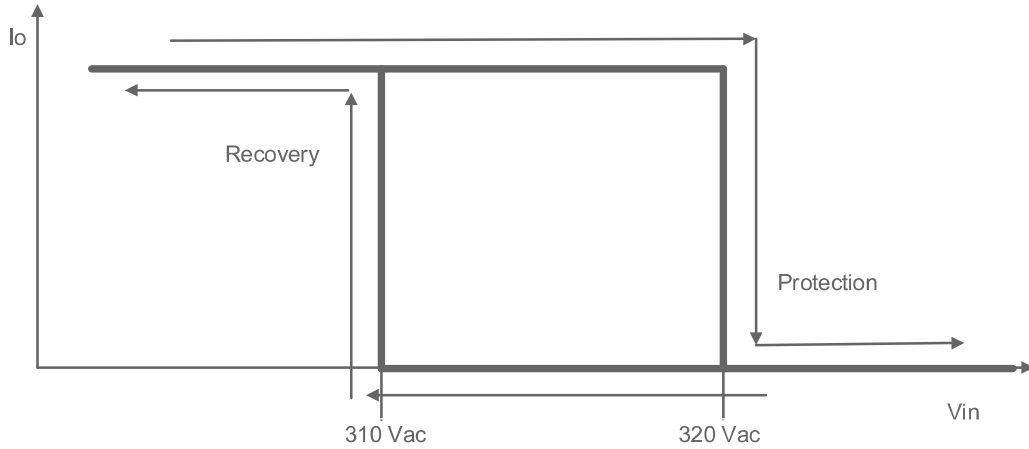

Dimming

● DALI-2 Dimming

The recommended implementation of the dimming control is provided below.

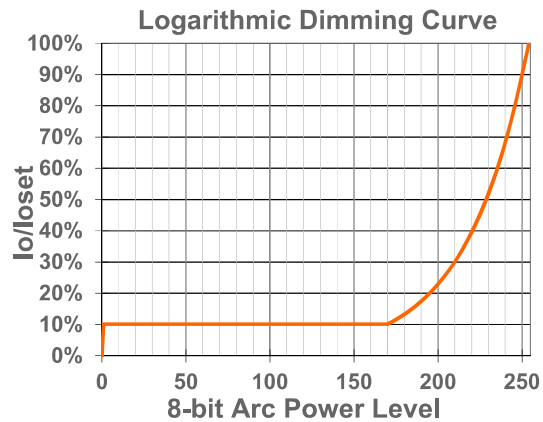
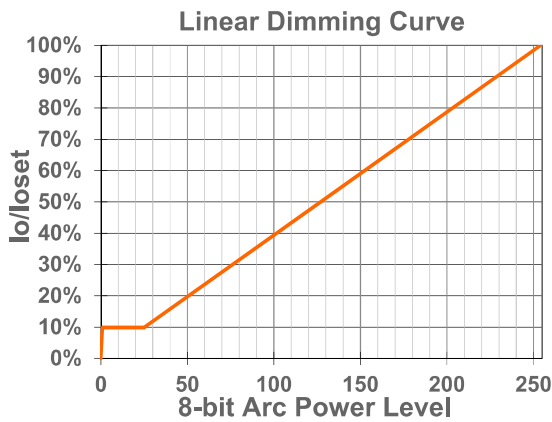
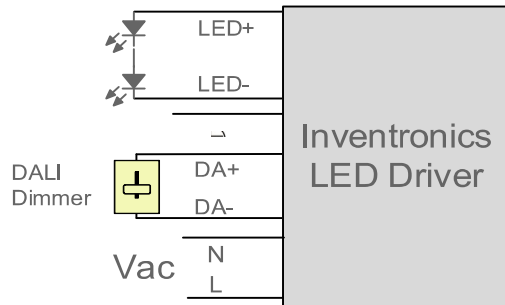

Implementation: DALI-2 Dimming

● Time Dimming

Time dimming control includes 3 kinds of modes, they are Self Adapting-Midnight, Self Adapting-Percentage and Traditional Timer.

- **Self Adapting-Midnight:** Automatically adjusts the dimming curve based on the on-time of past two days (if difference <15 minutes), assuming that the center point of the dimming curve is midnight local time.
- **Self Adapting-Percentage:** Automatically adjusts the on-time of each step by a constant percentage = (actual on-time for the past 2 days if difference <15 min) / (programmed on-time from the dimming curve).
- **Traditional Timer:** Follows the programmed timing curve after power on with no changes.

● AC Dimming

The default range of AC Dim is 160-250Vac. The range can be adjusted via the programming interface. Also, the Start Input Voltage, Start Output Level, Stop Input Voltage and Stop Output Level can be set. There needs to be a minimum of 20V difference between Start and Stop Input Voltage settings when programming the driver.

There must be a minimum voltage difference of 5V from the Start Input Voltage before the driver starts dimming.

Output Level

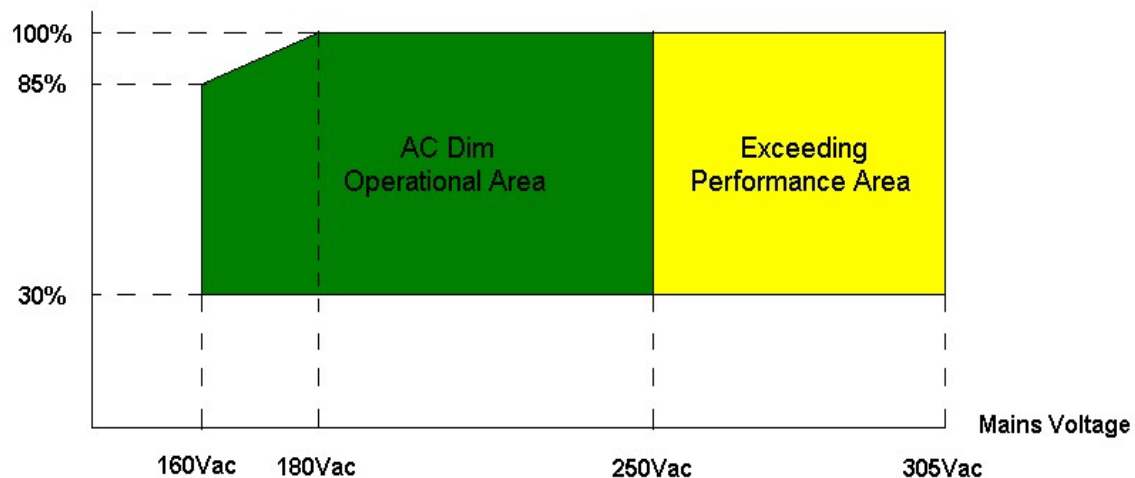

Notes:

1. In the green area, the driver will operate normally.
2. In the yellow area, the driver will operate safely but not fulfill requirements.

● Output Lumen Compensation

Output Lumen Compensation (OLC) may be used to maintain constant light output over the life of the LEDs by driving them at a reduced current when new, then gradually increasing the drive current over time to counteract LED lumen degradation.

● End Of Life

End-of-Life (EOL) is providing a visual notification to a user that the LED module has reached the end of manufacturer-specified life and that the replacement is recommended. Once active, an indication is given at each power-up of the driver, which the driver indicates this through a lower light output during the first 1 minute before normal operation is continued.

Wire Connection Diagram

| Parameter | | Min. | Typ. | Max. | Notes |
|---|--------------------|-------------------------------|------|-------------------------------|---|
| L, N,  | Wire Cross-section | 0.4 mm ² 20 AWG | - | 1.5 mm ² 16 AWG | Push-in at 45° angle, solid and stranded wire |
| | Strip Length | 8.5 mm | - | 9.5 mm | |
| LED+, LED-, NTC-, NTC+, +24V, DA+, DA- | Wire Cross-section | 0.2 mm ² 22 AWG | - | 1.5 mm ² 16 AWG | Push-in at 45° angle, solid and stranded wire |
| | Strip Length | 8.5 mm | - | 9.5 mm | |

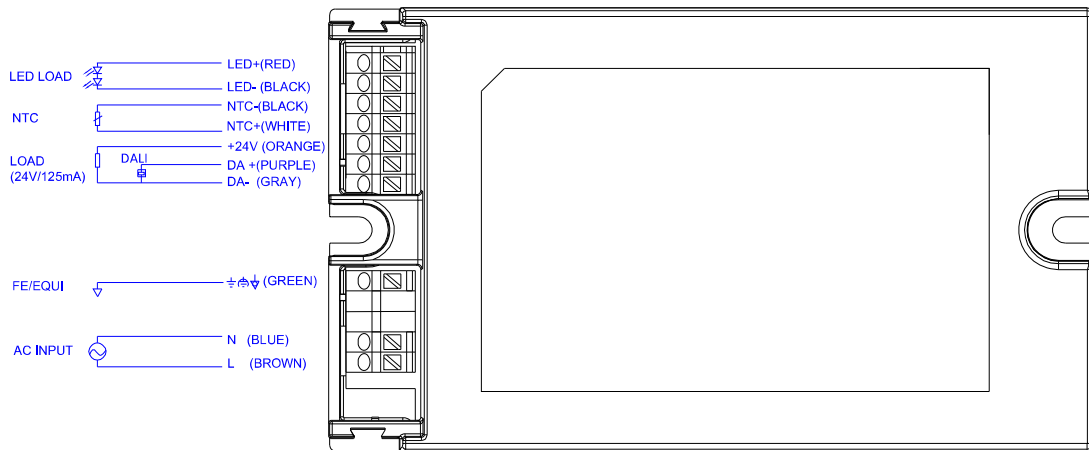

Programming Connection Diagram

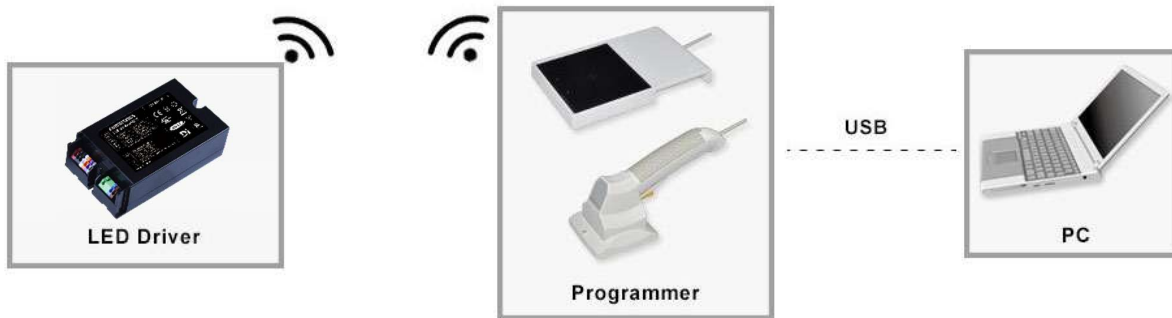

Note: The driver does not need to be powered on during the programming process.

- Please refer to [PRG-NFC-H](#) or [PRG-NFC-D2](#) (Programmer) datasheet for details.

Mechanical Outline

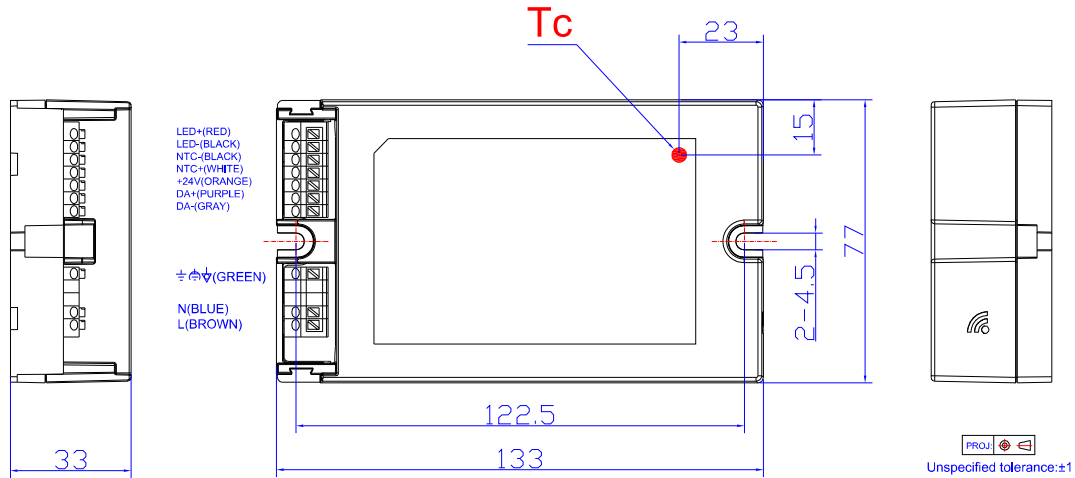

Optional Cable Clamp END-CAP02

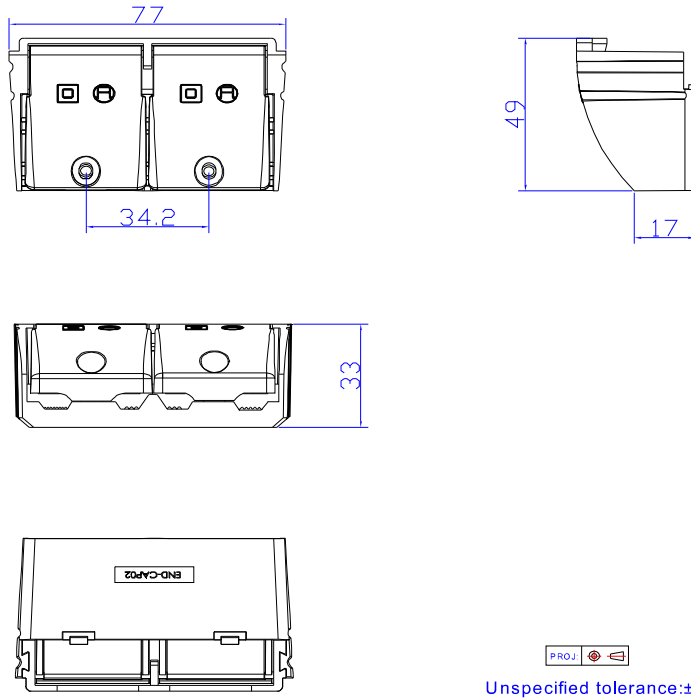

Note: The cable clamp is to be installed with EBS-040SxxxBT2 drivers for independent application. Please refer to [END-CAP02](#) datasheet for details.

RoHS Compliance

Our products comply with reference to RoHS Directive (EU) 2015/863 amending 2011/65/EU, calling for the elimination of lead and other hazardous substances from electronic products.

Revision History

| Change Date | Rev. | Description of Change | | |
|-------------|------|------------------------|-------------|---------|
| | | Item | From | To |
| 2020-09-08 | A | Datasheet Release | / | / |
| 2021-09-17 | B | Safety &EMC Compliance | CE | Updated |
| | | Safety &EMC Compliance | Performance | Added |
| 2022-04-15 | C | Product Photograph | / | Updated |
| | | UKCA/BIS logo | / | Added |
| | | Models | Notes(2)(4) | Updated |
| | | Safety &EMC Compliance | / | Updated |
| 2024-08-20 | D | Format | / | Updated |
| | | Product Photograph | / | Updated |
| | | UKCA/CCC logo | | Deleted |
| | | Models | Notes (2) | Updated |
| | | Output Specifications | / | Updated |
| | | Safety &EMC Compliance | / | Updated |