

Features

- Ultra High Efficiency (Up to 96.0%)
- Compact Metal Case with Excellent Thermal Performance
- Full Power at Wide Output Current Range (Constant Power)
- Adjustable Output Current (AOC) with Programmability
- Isolated 1-10V/10V PWM/3-Timer-Modes Dimmable
- Output Lumen Compensation
- End-of-Life Indicator
- Input Surge Protection: DM 6kV, CM 10kV
- All-Around Protection: OVP, SCP, OTP
- Low inrush current
- IP66 / IP67
- 5 Years Warranty



Description

The EBM-1K2SxxxDG series is a 1200W, constant-current, programmable and IP66/IP67 rated LED driver that operates from 176-305 Vac input with excellent power factor. Created for many lighting applications including high mast, sports, UV-LED, aquaculture and horticulture etc., The high efficiency of these drivers and compact metal case enables them to run cooler, significantly improving reliability and extending product life. To ensure trouble-free operation, protection is provided against input surge, output over voltage, short circuit, and over temperature.

Models

Adjustable Output Current Range	Full-Power Current Range(1)	Default Output Current	Input Voltage Range(2)	Output Voltage Range	Max. Output Power	Typical Efficiency (3)	Typical Power Factor		Model Number
							220Vac	277Vac	
0.26-3.5A	2.6-3.5A	3.5 A	176-305Vac 190~250Vdc	171 ~ 462Vdc	1200 W	95.5%	0.99	0.96	EBM-1K2S350DG
0.395-5.25A	3.95-5.25A	5.25 A	176-305Vac 190~250Vdc	114 ~ 304Vdc	1200 W	95.0%	0.99	0.96	EBM-1K2S525DG
0.555-7.4A	5.55-7.4A	7.4 A	176-305Vac 190~250Vdc	81 ~ 217Vdc	1200 W	95.0%	0.99	0.96	EBM-1K2S740DG

- Notes:** (1) Output current range with constant power at 1200W.
 (2) Certified input voltage range: 200-240Vac.
 (3) Measured at 100% load and 220Vac input (see below "General Specifications" for details).

I-V Operating Area

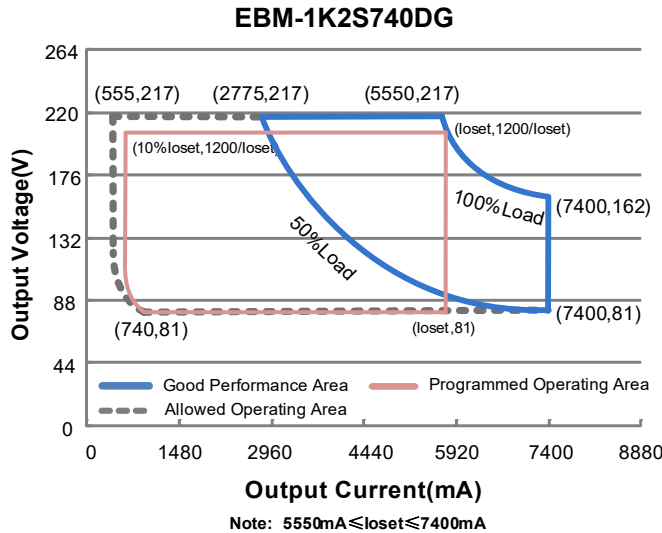
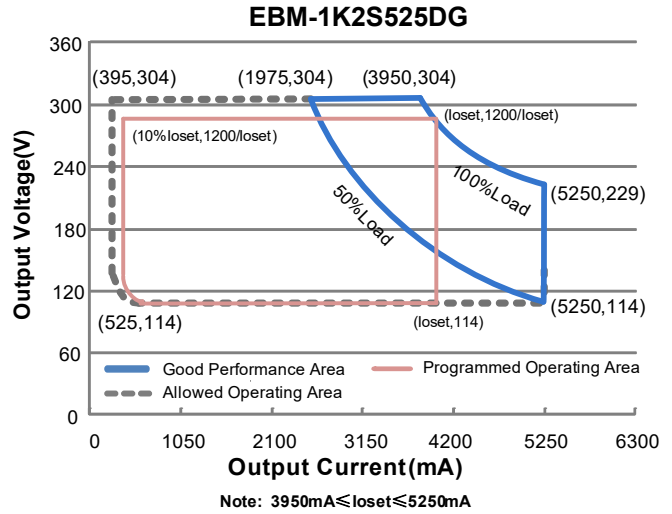
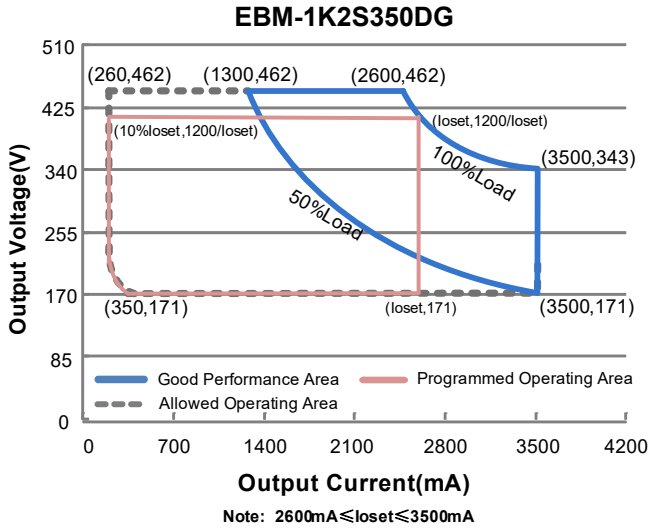

Input Specifications

Parameter	Min.	Typ.	Max.	Notes
Input AC Voltage	176 Vac	-	305 Vac	
Input DC Voltage	190 Vdc	-	250 Vdc	
Input Frequency	47 Hz	-	63 Hz	
Leakage Current	-	-	0.70 mA	IEC60598-1; 240Vac/ 60Hz, grounding effectively
Input AC Current	-	-	6.40 A	Measured at 100% load and 220 Vac input.
Inrush Current(I ² t)	-	-	2.70 A ² s	At 220Vac input, 25°C cold start, duration=19.8 ms, 10%I _{pk} -10%I _{pk} . See Inrush Current Waveform for the details.
PF	0.90	-	-	At 200-277Vac, 50-60Hz, 50%-100% Load (600 - 1200W)
THD	-	-	20%	
THD	-	-	10%	At 220-240Vac, 50-60Hz, 75%-100% Load (900 - 1200W)

Output Specifications

Parameter	Min.	Typ.	Max.	Notes
Output Current Tolerance	-5%loset	-	5%loset	100% load
Output Current Setting(loset) Range				
EBM-1K2S350DG	260 mA	-	3500 mA	
EBM-1K2S525DG	395 mA	-	5250 mA	
EBM-1K2S740DG	555 mA	-	7400 mA	
Output Current Setting Range with Constant Power				
EBM-1K2S350DG	2600 mA	-	3500 mA	
EBM-1K2S525DG	3950 mA	-	5250 mA	
EBM-1K2S740DG	5550 mA	-	7400 mA	
Total Output Current Ripple (pk-pk)	-	5%lomax	10%lomax	100% load, 20 MHz BW
Output Current Ripple at < 200 Hz (pk-pk)	-		2%lomax	100% load
Startup Overshoot Current	-	-	10%lomax	100% load
No Load Output Voltage				
EBM-1K2S350DG	-	-	500 V	
EBM-1K2S525DG	-	-	340 V	
EBM-1K2S740DG	-	-	240 V	
Line Regulation	-	-	±0.5%	100% load
Load Regulation	-	-	±1.5%	
Turn-on Delay Time	-	-	0.5 s	Measured at 200-277Vac input, 50%-100% Load
Temperature Coefficient of loiset	-	0.03%/°C	-	Case temperature = 0°C ~Tc max

General Specifications

Parameter	Min.	Typ.	Max.	Notes
Efficiency at 220 Vac input:				
EBM-1K2S350DG				Measured at 100% load and steady-state temperature in 25°C ambient; (Efficiency will be about 2.0% lower if measured immediately after startup.)
lo= 2600 mA	93.0%	95.0%	-	
lo= 3500 mA	93.5%	95.5%	-	
EBM-1K2S525DG				
lo= 3950 mA	93.0%	95.0%	-	
lo= 5250 mA	93.0%	95.0%	-	
EBM-1K2S740DG				
lo= 5550 mA	93.0%	95.0%	-	
lo= 7400 mA	93.0%	95.0%	-	
Efficiency at 277 Vac input:				
EBM-1K2S350DG				Measured at 100% load and steady-state temperature in 25°C ambient; (Efficiency will be about 2.0% lower if measured immediately after startup.)
lo= 2600 mA	94.0%	96.0%	-	
lo= 3500 mA	94.0%	96.0%	-	
EBM-1K2S525DG				
lo= 3950 mA	93.5%	95.5%	-	
lo= 5250 mA	93.5%	95.5%	-	
EBM-1K2S740DG				
lo= 5550 mA	93.5%	95.5%	-	
lo= 7400 mA	93.5%	95.5%	-	
MTBF	-	203,000 Hours	-	Measured at 220Vac input, 80%Load and 25°C ambient temperature (MIL-HDBK-217F)

General Specifications (Continued)

Parameter	Min.	Typ.	Max.	Notes
Lifetime	-	100,000 Hours	-	Measured at 220Vac input, 80%Load and 70°C case temperature; See lifetime vs. Tc curve for the details
	-	54,000 Hours	-	Measured at 220Vac input, 100%Load and 40°C ambient temperature
Operating Case Temperature for Safety Tc _s	-40°C	-	+90°C	
Operating Case Temperature for Warranty Tc _w	-40°C	-	+80°C	Case temperature for 5 years warranty Humidity: 10% RH to 95% RH;
Storage Temperature	-40°C	-	+85°C	Humidity: 5%RH to 95%RH
Dimensions Inches (L × W × H) Millimeters (L × W × H)	11.22 × 5.55 × 1.91 285 × 141 × 48.5			With mounting ear 12.21 × 5.55 × 1.91 310 × 141 × 48.5
Net Weight	-	3800 g	-	

Dimming Specifications

Parameter	Min.	Typ.	Max.	Notes	
Absolute Maximum Voltage on the Vdim (+) Pin	-20 V	-	20 V		
Source Current on Vdim (+)Pin	200 uA	300 uA	450 uA	Vdim(+) = 0 V	
Dimming Output Range	EBM-1K2S350DG EBM-1K2S525DG EBM-1K2S740DG	10%loset	-	loset	2600 mA ≤ loiset ≤ 3500 mA 3950 mA ≤ loiset ≤ 5250 mA 5550 mA ≤ loiset ≤ 7400 mA
	EBM-1K2S350DG EBM-1K2S525DG EBM-1K2S740DG	260 mA 395 mA 555 mA	-	loiset	260 mA ≤ loiset < 2600 mA 395 mA ≤ loiset < 3950 mA 555 mA ≤ loiset < 5550 mA
Recommended Dimming Input Range	1 V	-	9 V	Default 1-10V dimming mode with positive logic.	
PWM_in High Level	-	10V	-		
PWM_in Low Level	-	0V	-		
PWM_in Frequency Range	200 Hz	-	2 KHz		
PWM_in Duty Cycle	0%	-	100%		

Safety & EMC Compliance

Safety Category	Standard
ENEC & CE	EN 61347-1, EN 61347-2-13
UKCA	BS EN 61347-1, BS EN 61347-2-13
CB	IEC 61347-1, IEC 61347-2-13
CCC	GB 19510.1, GB 19510.14
KC	K 61347-1, K 61347-2-13
EAC	ГОСТ Р МЭК 61347-1, ГОСТ IEC 61347-2-13

Safety & EMC Compliance (Continued)

EMI Standards	Notes
EN 55015/GB 17743/KN 15 ⁽¹⁾	Conducted emission Test & Radiated emission Test
EN 61000-3-2/GB 17625.1	Harmonic current emissions
EN 61000-3-3	Voltage fluctuations & flicker
EMS Standards	Notes
EN 61000-4-2	Electrostatic Discharge (ESD): 8 kV air discharge, 4 kV contact discharge
EN 61000-4-3	Radio-Frequency Electromagnetic Field Susceptibility Test-RS
EN 61000-4-4	Electrical Fast Transient / Burst-EFT
EN 61000-4-5	Surge Immunity Test: AC Power Line: Differential Mode 6 kV, Common Mode 10 kV
EN 61000-4-6	Conducted Radio Frequency Disturbances Test-CS
EN 61000-4-8	Power Frequency Magnetic Field Test
EN 61000-4-11	Voltage Dips
EN 61547	Electromagnetic Immunity Requirements Applies To Lighting Equipment

Note: (1) This LED driver meets the EMI specifications above, but EMI performance of a luminaire that contains it depends also on the other devices connected to the driver and on the fixture itself.

Derating

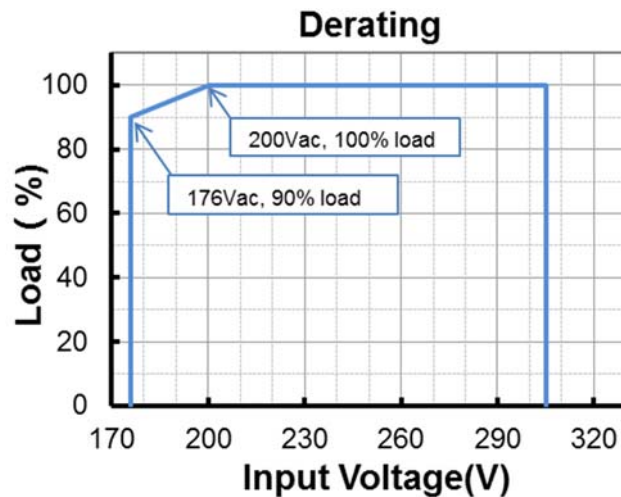

Lifetime vs. Case Temperature

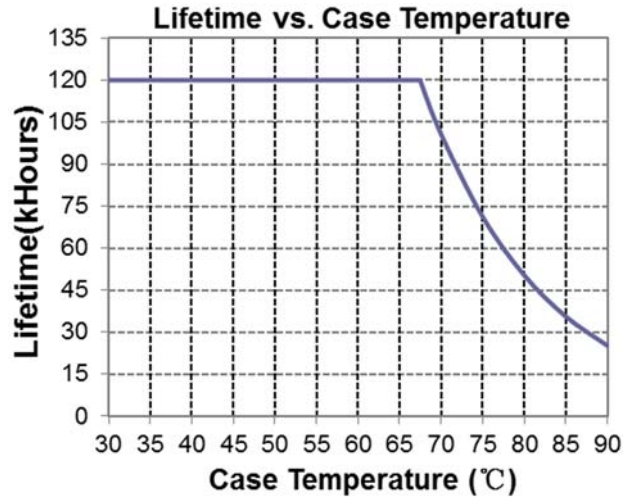

Inrush Current Waveform

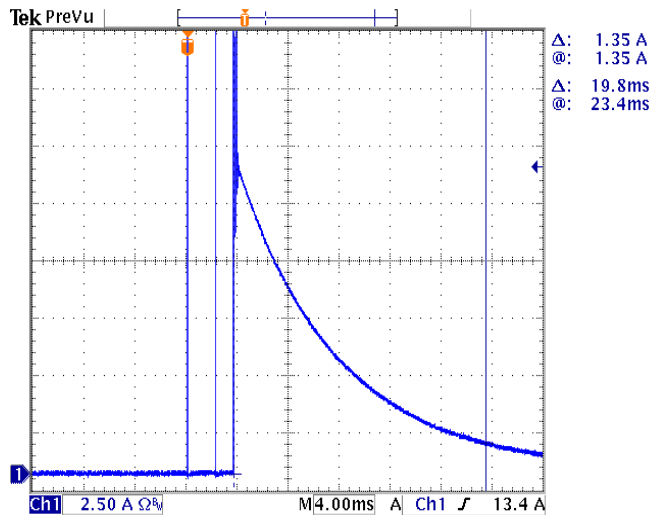

Efficiency vs. Load

EBM-1K2S350DG ($I_o=2600mA$)

Efficiency vs. Output Voltage

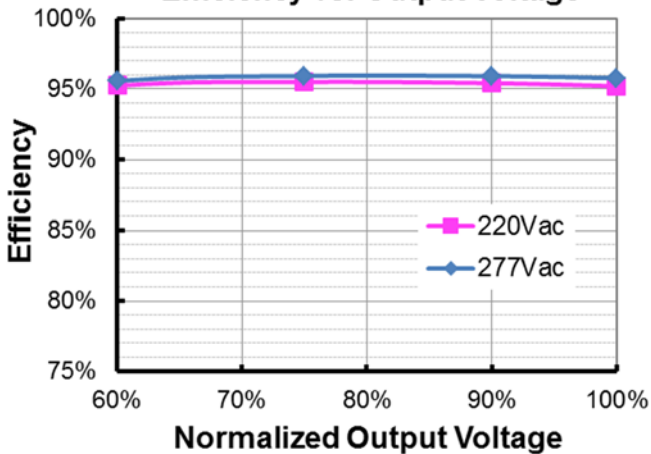

EBM-1K2S350DG ($I_o=3500mA$)

Efficiency vs. Output Voltage

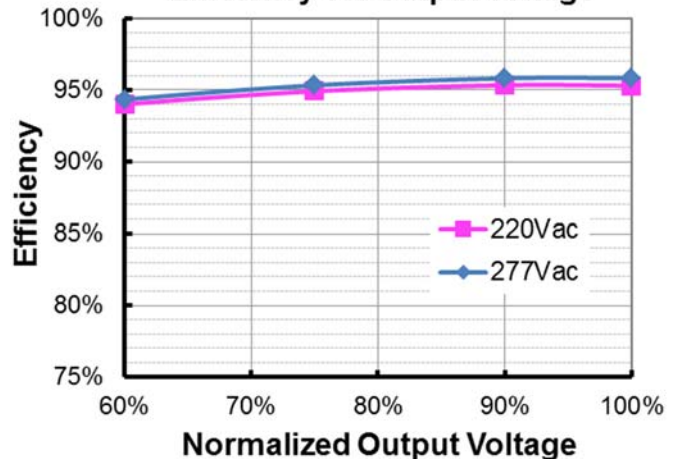

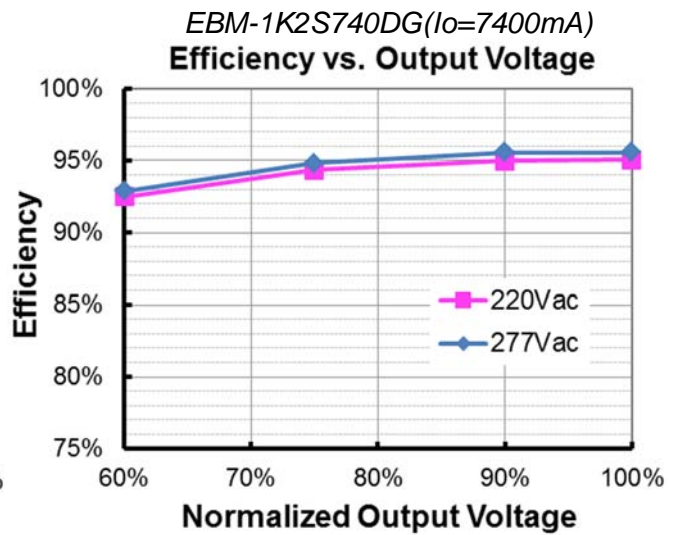
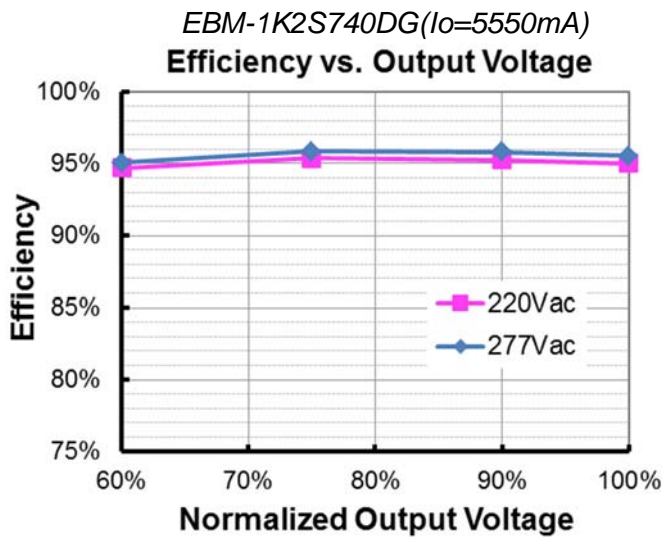
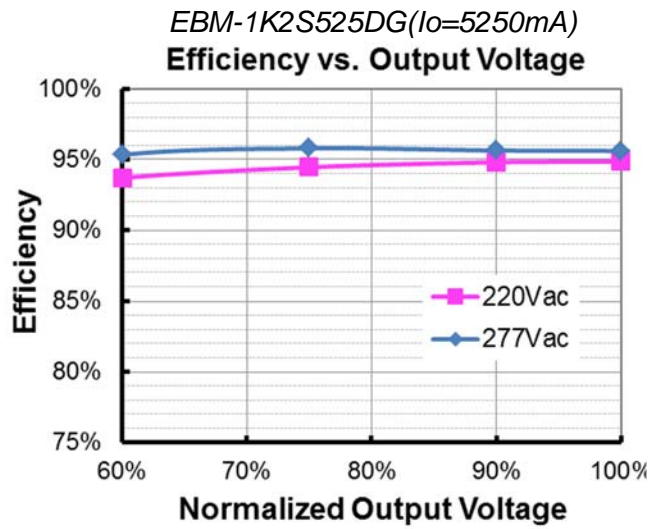
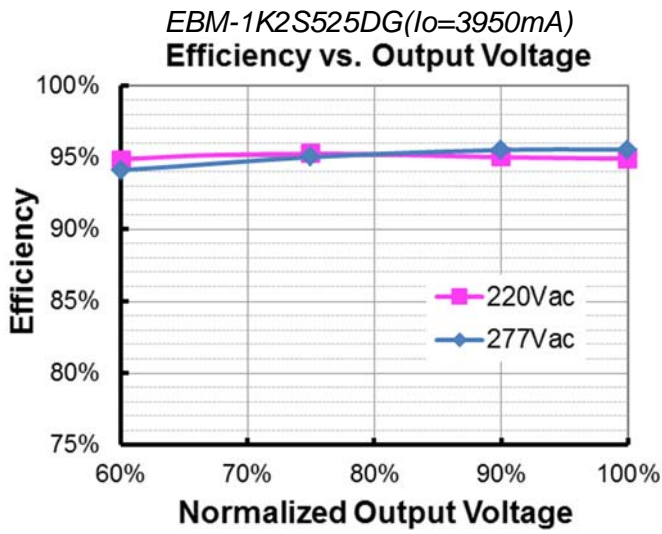

Power Factor

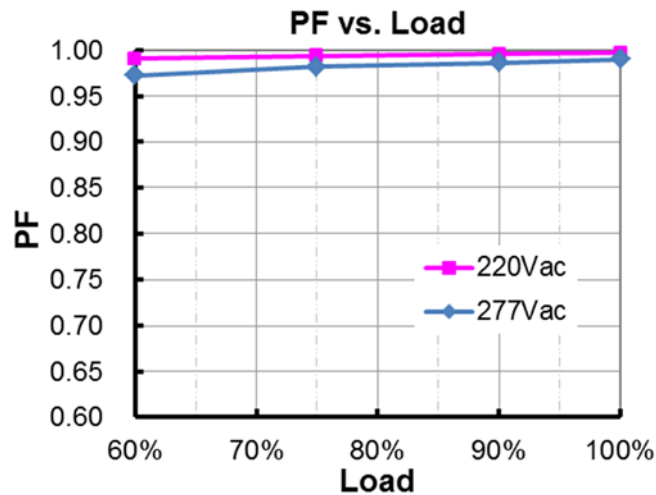

Total Harmonic Distortion

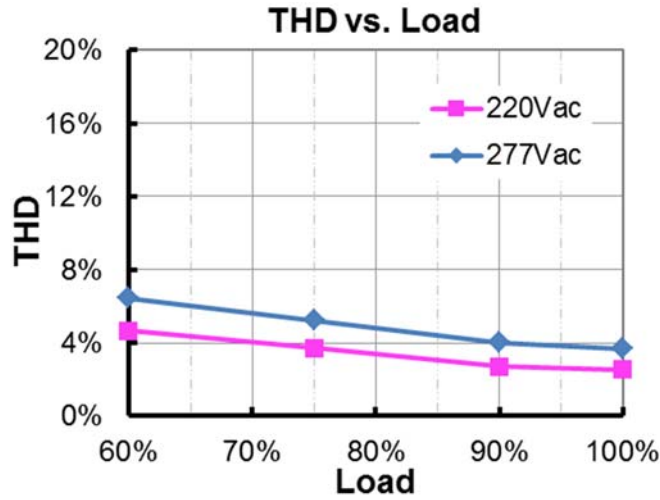

Protection Functions

Parameter	Min.	Typ.	Max.	Notes
Over Voltage Protection	Limits output voltage at no load and in case the normal voltage limit fails.			
Short Circuit Protection	Auto Recovery. No damage will occur when any output is short circuited. The output shall return to normal when the fault condition is removed.			
Over Temperature Protection	Decreases output current, returning to normal after over temperature is removed.			

Dimming

● 1-10V Dimming

The recommended implementation of the dimming control is provided below.

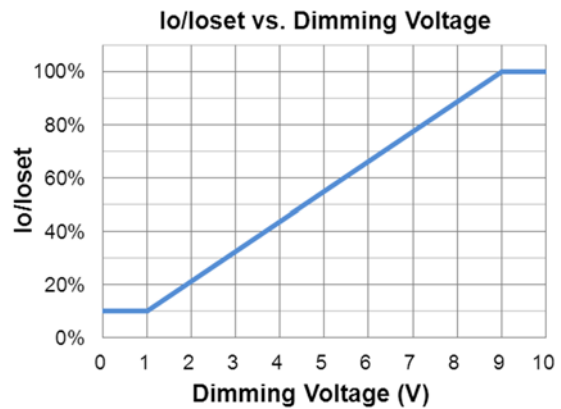
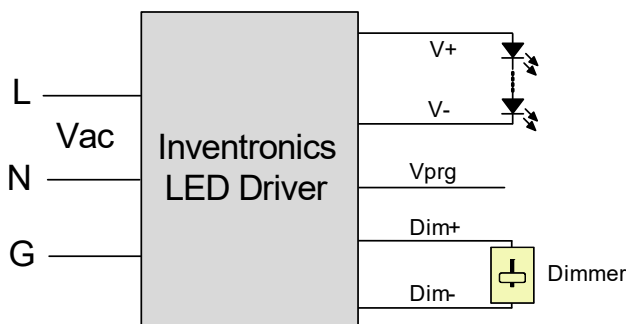

Implementation 3: Positive logic

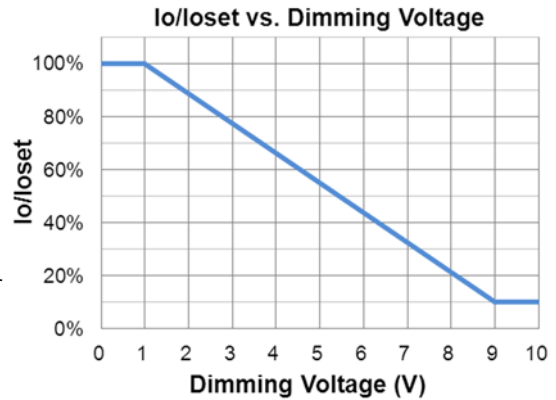
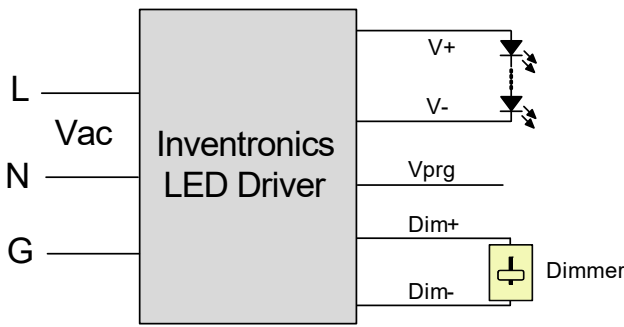

Implementation 4: Negative logic

Notes:

1. The dimmer can also be replaced by an active 1-10V voltage source signal or passive components like zener.
2. When 1-10V negative logic dimming mode and Dim+ is open, the driver will output minimum current.

● 10V PWM Dimming

The recommended implementation of the dimming control is provided below.

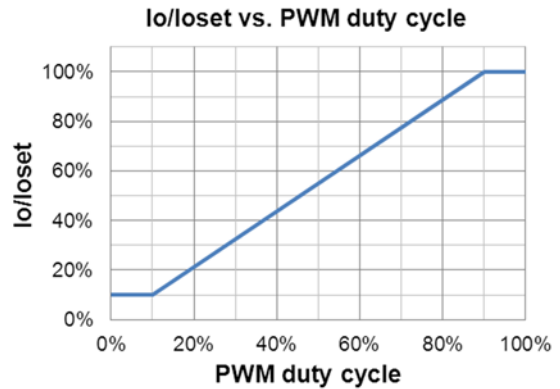
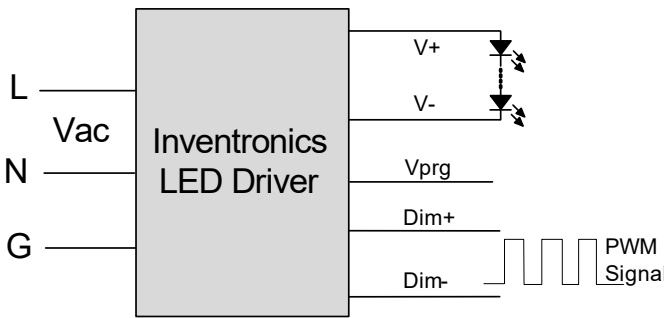

Implementation 5: Positive logic

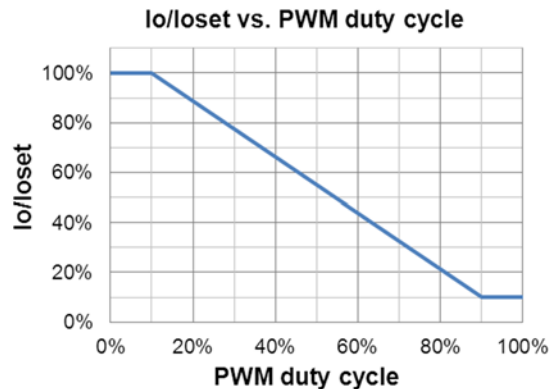
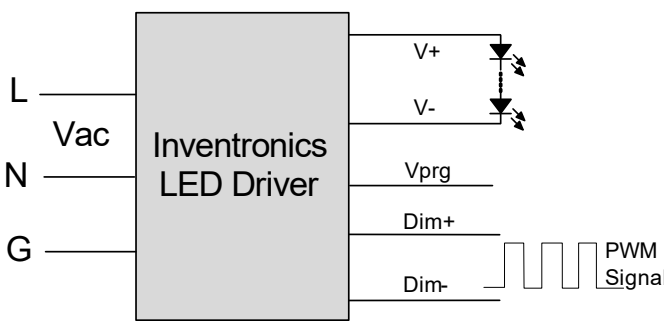

Implementation 6: Negative logic

Notes:

1. Do NOT connect Dim- to the output V- or V+, otherwise the driver will not work properly.
2. When PWM negative logic dimming mode and Dim+ is open, the driver will output minimum current.

● Time Dimming

Time dimming control includes 3 kinds of modes, they are Self Adapting-Midnight, Self Adapting-Percentage and Traditional Timer.

- **Self Adapting-Midnight:** Automatically adjusts the dimming curve based on the on-time of past two days (if difference <15 minutes), assuming that the center point of the dimming curve is midnight local time.
- **Self Adapting-Percentage:** Automatically adjusts the on-time of each step by a constant percentage = (actual on-time for the past 2 days if difference <15 min) / (programmed on-time from the dimming curve).
- **Traditional Timer:** Follows the programmed timing curve after power on with no changes.

● Output Lumen Compensation

Output Lumen Compensation (OLC) may be used to maintain constant light output over the life of the LEDs by driving them at a reduced current when new, then gradually increasing the drive current over time to counteract LED lumen degradation.

● End Of Life

End-of-Life (EOL) is providing a visual notification to a user that the LED module has reached the end of manufacturer-specified life and that the replacement is recommended. Once active, an indication is given at each power-up of the driver, which the driver indicates this through a lower light output during the first 1 minute before normal operation is continued.

Programming Connection Diagram

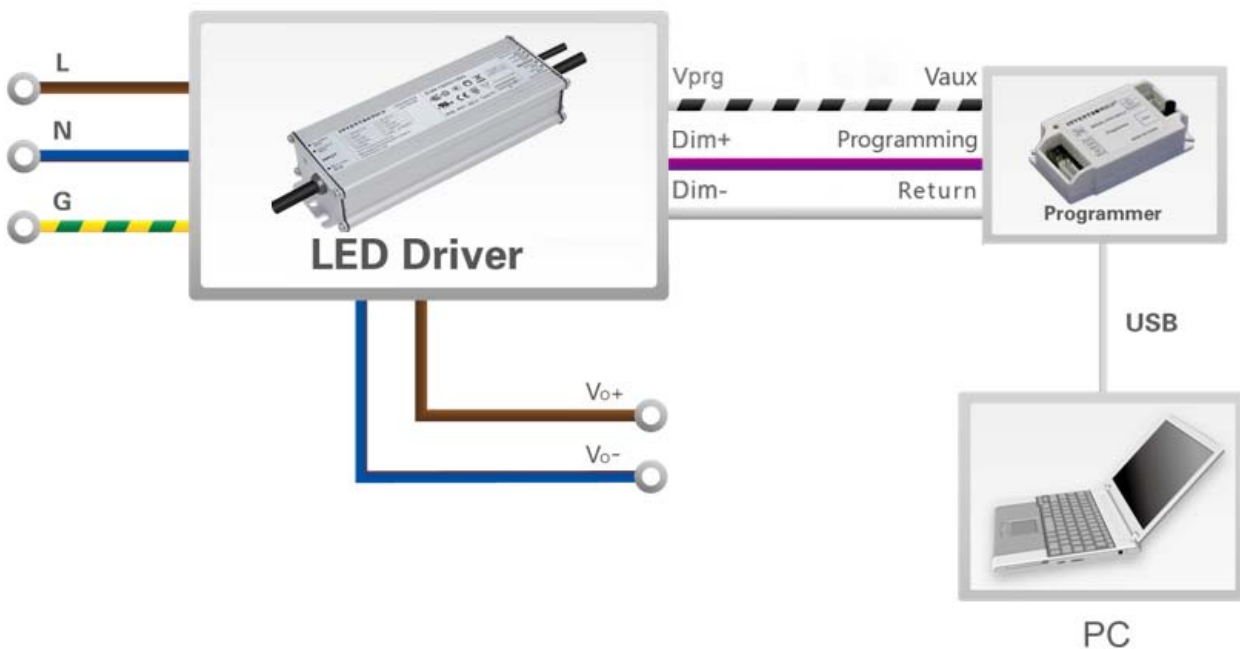

Note: The driver does not need to be powered on during the programming process.

- Please refer to [PRG-MUL2](#) (Programmer) datasheet for details.

Mechanical Outline

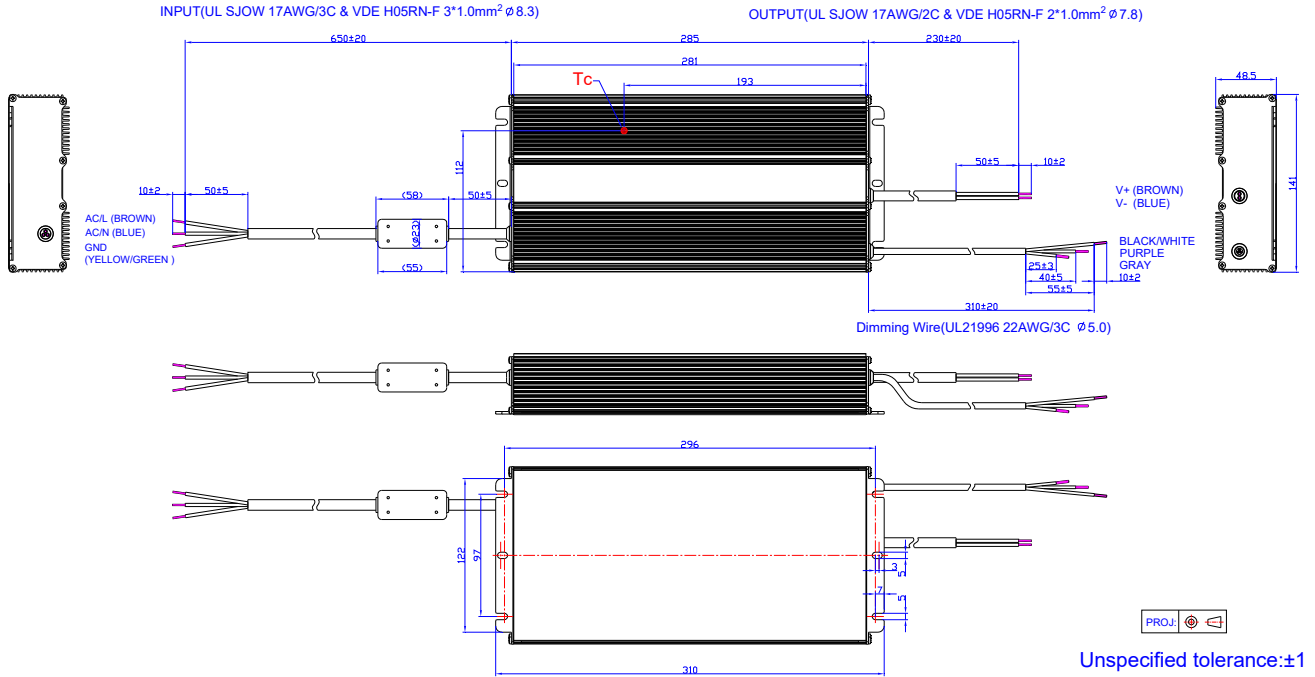

RoHS Compliance

Our products comply with reference to RoHS Directive (EU) 2015/863 amending 2011/65/EU, calling for the elimination of lead and other hazardous substances from electronic products.

Revision History

Change Date	Rev.	Description of Change		
		Item	From	To
2021-02-05	A	Datasheet Release	/	/
2021-12-02	B	ENEC logo	/	Updated
		UKCA logo	/	Updated
		Safety &EMC Compliance	ENEC	Updated
		Safety &EMC Compliance	UKCA	Updated
2021-12-17	C	Product Photograph	/	Updated
		EAC logo	/	Added
		Safety &EMC Compliance	EAC	Added