

Features

- Ultra High Efficiency (Up to 96.0%)
- Compact Metal Case with Excellent Thermal Performance
- Full Power at Wide Output Current Range (Constant Power)
- Adjustable Output Current (AOC) with Programmability
- Isolated 0-10V/PWM/3-Timer-Modes Dimmable
- INV Digital Dimming, UART Based Communication Protocol
- Dim-to-Off with Standby Power ≤ 0.5 W
- Always-on Auxiliary Power: 12Vdc, 250mA
- Output Lumen Compensation
- End-of-Life Indicator
- Input Surge Protection: DM 6kV, CM 10kV
- All-Around Protection: IUVP, IOVP, OVP, SCP, OTP
- Low inrush current
- IP66 / IP67
- 5 Years Warranty



Description

The EBM-1K2SxxxMG series is a 1200W, constant-current, programmable and IP66/IP67 rated LED driver that operates from 176-305 Vac input with excellent power factor. Created for many lighting applications including high mast, sports, UV-LED, aquaculture and horticulture etc., this family provides an auxiliary voltage and dim-to-off functionality for powering low voltage, wireless controls. The dimming control supports 0-10V dimming as well as two-way communication via Digital Dimming, a UART based communication protocol. The high efficiency of these drivers and compact metal case enables them to run cooler, significantly improving reliability and extending product life. To ensure trouble-free operation, protection is provided against input surge, input under voltage, input over voltage, output over voltage, short circuit, and over temperature.

Models

Adjustable Output Current Range	Full-Power Current Range(1)	Default Output Current	Input Voltage Range(2)	Output Voltage Range	Max. Output Power	Typical Efficiency (3)	Typical Power Factor		Model Number
							220Vac	277Vac	
0.26-3.5A	2.6-3.5A	3.5 A	176-305Vac 190~250Vdc	171 ~ 462Vdc	1200 W	95.5%	0.99	0.96	EBM-1K2S350MG
0.395-5.25A	3.95-5.25A	5.25 A	176-305Vac 190~250Vdc	114 ~ 304Vdc	1200 W	95.0%	0.99	0.96	EBM-1K2S525MG
0.555-7.4A	5.55-7.4A	7.4 A	176-305Vac 190~250Vdc	81 ~ 217Vdc	1200 W	95.0%	0.99	0.96	EBM-1K2S740MG

Notes: (1) Output current range with constant power at 1200W.

(2) Certified input voltage range: 200-240Vac.

(3) Measured at 100% load and 220Vac input (see below "General Specifications" for details).

I-V Operating Area

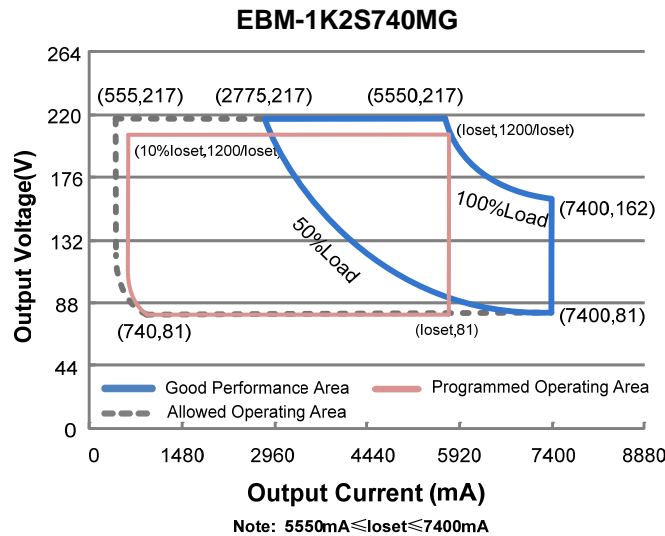
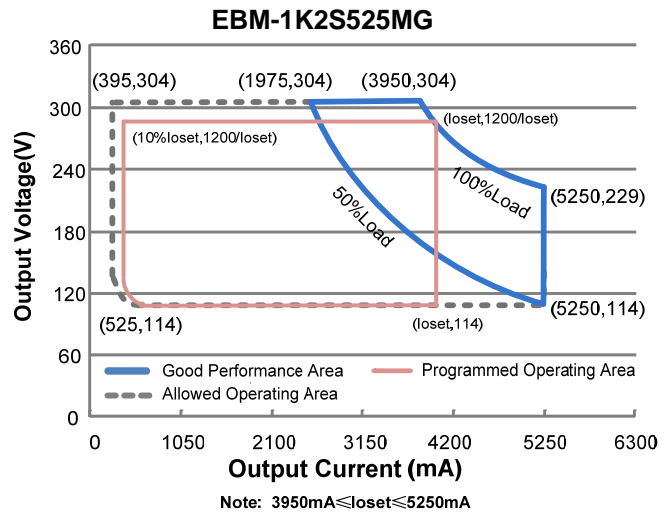
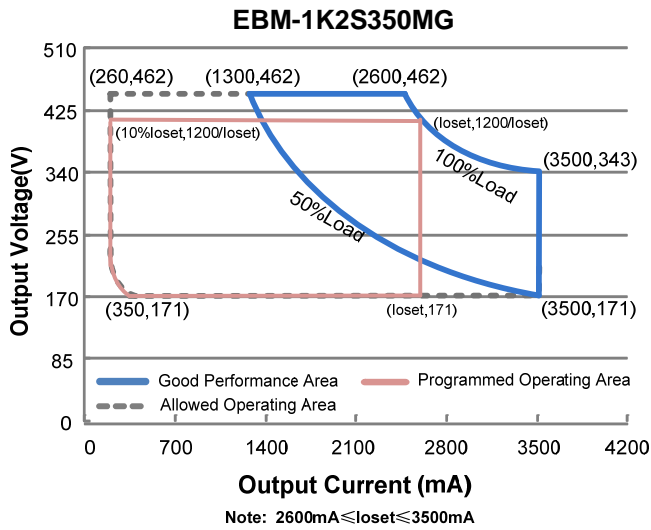

Input Specifications

Parameter	Min.	Typ.	Max.	Notes
Input AC Voltage	176 Vac	-	305 Vac	
Input DC Voltage	190 Vdc	-	250 Vdc	
Input Frequency	47 Hz	-	63 Hz	
Leakage Current	-	-	0.70 mA	IEC60598-1; 240Vac/ 60Hz, grounding effectively
Input AC Current	-	-	6.40 A	Measured at 100% load and 220 Vac input.
Inrush Current(I ² t)	-	-	2.70 A ² s	At 220Vac input, 25°C cold start, duration=19.8 ms, 10%Ipk-10%Ipk. See Inrush Current Waveform for the details.
PF	0.90	-	-	At 200-277Vac, 50-60Hz, 50%-100% Load (600 - 1200W)
THD	-	-	20%	
THD	-	-	10%	At 220-240Vac, 50-60Hz, 75%-100% Load (900 - 1200W)

Output Specifications

Parameter	Min.	Typ.	Max.	Notes
Output Current Tolerance	-5%loset	-	5%loset	100% load
Output Current Setting(loset) Range				
EBM-1K2S350MG	260 mA	-	3500 mA	
EBM-1K2S525MG	395 mA	-	5250 mA	
EBM-1K2S740MG	555 mA	-	7400 mA	
Output Current Setting Range with Constant Power				
EBM-1K2S350MG	2600 mA	-	3500 mA	
EBM-1K2S525MG	3950 mA	-	5250 mA	
EBM-1K2S740MG	5550 mA	-	7400 mA	
Total Output Current Ripple (pk-pk)	-	5%lomax	10%lomax	100% load, 20 MHz BW
Output Current Ripple at < 200 Hz (pk-pk)	-		2%lomax	100% load
Startup Overshoot Current	-	-	10%lomax	100% load
No Load Output Voltage				
EBM-1K2S350MG	-	-	500 V	
EBM-1K2S525MG	-	-	340 V	
EBM-1K2S740MG	-	-	240 V	
Line Regulation	-	-	±0.5%	100% load
Load Regulation	-	-	±1.5%	
Turn-on Delay Time	-	-	0.5 s	Measured at 200-277Vac input, 50%-100% Load
Temperature Coefficient of loset	-	0.03%/°C	-	Case temperature = 0°C ~Tc max
12V Auxiliary Output Voltage	10.8 V	12 V	13.2 V	
12V Auxiliary Output Source Current	0 mA	-	250 mA	Return terminal is "Dim"
12V Auxiliary Output Transient Peak Current@6W	-	-	500 mA	500mA peak for a maximum duration of 2.2 ms in a 6.0ms period during which time the average should not exceed 250mA.
12V Auxiliary Output Transient Peak Current@10W	-	-	850 mA	850mA peak for a maximum duration of 1.3 ms in a 5.2ms period during which time the average should not exceed 250mA.

General Specifications

Parameter	Min.	Typ.	Max.	Notes
Efficiency at 220 Vac input:				
EBM-1K2S350MG				
Io= 2600 mA	93.0%	95.0%	-	Measured at 100% load and steady-state temperature in 25°C ambient; (Efficiency will be about 2.0% lower if measured immediately after startup.)
Io= 3500 mA	93.5%	95.5%	-	
EBM-1K2S525MG				
Io= 3950 mA	93.0%	95.0%	-	
Io= 5250 mA	93.0%	95.0%	-	
EBM-1K2S740MG				
Io= 5550 mA	93.0%	95.0%	-	
Io= 7400 mA	93.0%	95.0%	-	

General Specifications (Continued)

Parameter	Min.	Typ.	Max.	Notes
Efficiency at 277 Vac input: EBM-1K2S350MG I _o = 2600 mA I _o = 3500 mA EBM-1K2S525MG I _o = 3950 mA I _o = 5250 mA EBM-1K2S740MG I _o = 5550 mA I _o = 7400 mA	94.0% 94.0% 93.5% 93.5% 93.5% 93.5%	96.0% 96.0% 95.5% 95.5% 95.5% 95.5%	- - - - - -	
Standby Power	-	-	0.5 W	Measured at 230Vac/50Hz; Dimming off
MTBF	-	203,000 Hours	-	Measured at 220Vac input, 80%Load and 25°C ambient temperature (MIL-HDBK-217F)
Lifetime	-	100,000 Hours	-	Measured at 220Vac input, 80%Load and 70°C case temperature; See lifetime vs. T _c curve for the details
	-	54,000 Hours	-	Measured at 220Vac input, 100%Load and 40°C ambient temperature
Operating Case Temperature for Safety T _{c_s}	-40°C	-	+90°C	
Operating Case Temperature for Warranty T _{c_w}	-40°C	-	+80°C	Case temperature for 5 years warranty Humidity: 10% RH to 95% RH;
Storage Temperature	-40°C	-	+85°C	Humidity: 5%RH to 95%RH
Dimensions Inches (L × W × H) Millimeters (L × W × H)	11.22 × 5.55 × 1.91 285 × 141 × 48.5			With mounting ear 12.21 × 5.55 × 1.91 310 × 141 × 48.5
Net Weight	-	3800 g	-	

Dimming Specifications

Parameter	Min.	Typ.	Max.	Notes	
Absolute Maximum Voltage on the V _{dim} (+) Pin	-20 V	-	20 V		
Source Current on V _{dim} (+)Pin	200 uA	300 uA	450 uA	V _{dim} (+) = 0 V	
Dimming Output Range	E _B M-1K2S350MG E _B M-1K2S525MG E _B M-1K2S740MG	10%I _o set	-	I _o set	2600 mA ≤ I _o set ≤ 3500 mA 3950 mA ≤ I _o set ≤ 5250 mA 5550 mA ≤ I _o set ≤ 7400 mA
	E _B M-1K2S350MG E _B M-1K2S525MG E _B M-1K2S740MG	260 mA 395 mA 555 mA	-	I _o set	260 mA ≤ I _o set < 2600 mA 395 mA ≤ I _o set < 3950 mA 555 mA ≤ I _o set < 5550 mA
	Recommended Dimming Input Range	0 V	-	10 V	Default 0-10V dimming mode.
Dim off Voltage	0.35 V	0.5 V	0.65 V		
Dim on Voltage	0.55 V	0.7 V	0.85 V		
Hysteresis	-	0.2 V	-		

Dimming Specifications (Continued)

Parameter	Min.	Typ.	Max.	Notes
PWM_in High Level	3 V	-	10 V	Dimming mode set to PWM in PC interface.
PWM_in Low Level	-0.3 V	-	0.6 V	
PWM_in Frequency Range	200 Hz	-	3 KHz	
PWM_in Duty Cycle	1%	-	99%	
PWM Dimming off (Positive Logic)	3%	5%	8%	
PWM Dimming on (Positive Logic)	5%	7%	10%	
PWM Dimming off (Negative Logic)	92%	95%	97%	
PWM Dimming on (Negative Logic)	90%	93%	95%	
Hysteresis	-	2%	-	

Safety & EMC Compliance

Safety Category	Standard
CE	EN 61347-1, EN61347-2-13
CB	IEC 61347-1, IEC 61347-2-13
CCC	GB 19510.1, GB 19510.14
KC	K 61347-1, K 61347-2-13
EMI Standards	Notes
EN 55015/GB 17743/KN 15 ⁽¹⁾	Conducted emission Test & Radiated emission Test
EN 61000-3-2/GB 17625.1	Harmonic current emissions
EN 61000-3-3	Voltage fluctuations & flicker
EMS Standards	Notes
EN 61000-4-2	Electrostatic Discharge (ESD): 8 kV air discharge, 4 kV contact discharge
EN 61000-4-3	Radio-Frequency Electromagnetic Field Susceptibility Test-RS
EN 61000-4-4	Electrical Fast Transient / Burst-EFT
EN 61000-4-5	Surge Immunity Test: AC Power Line: Differential Mode 6 kV, Common Mode 10 kV
EN 61000-4-6	Conducted Radio Frequency Disturbances Test-CS
EN 61000-4-8	Power Frequency Magnetic Field Test
EN 61000-4-11	Voltage Dips
EN 61547	Electromagnetic Immunity Requirements Applies To Lighting Equipment

Note: (1) This LED driver meets the EMI specifications above, but EMI performance of a luminaire that contains it depends also on the other devices connected to the driver and on the fixture itself.

Derating

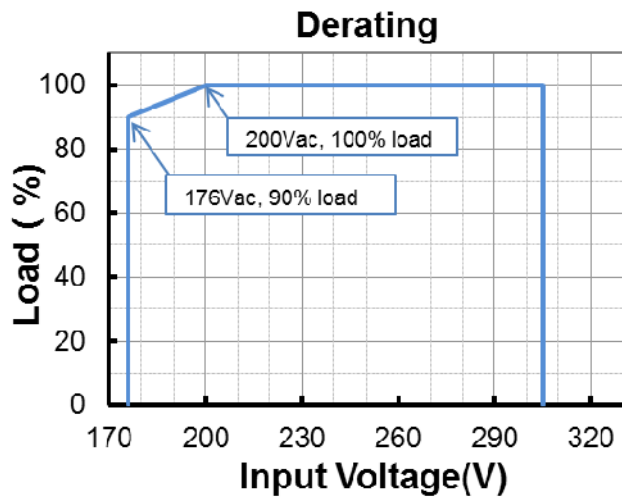

Lifetime vs. Case Temperature

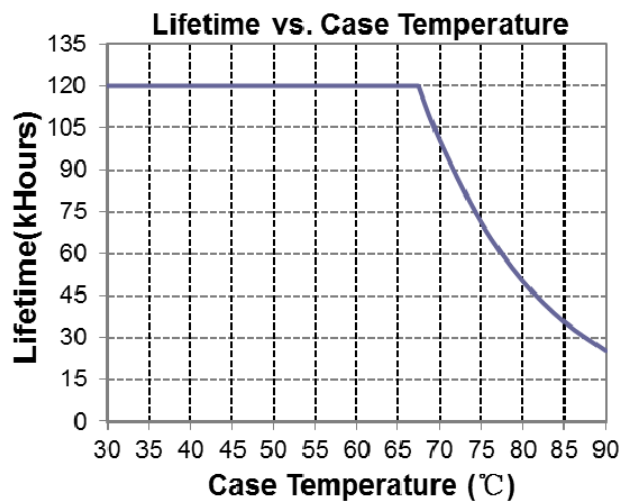

Inrush Current Waveform

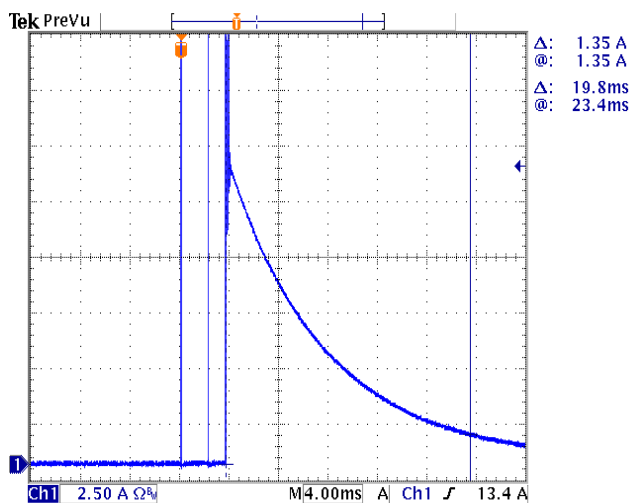

Efficiency vs. Load

EBM-1K2S350MG (Io=2600mA)
Efficiency vs. Output Voltage

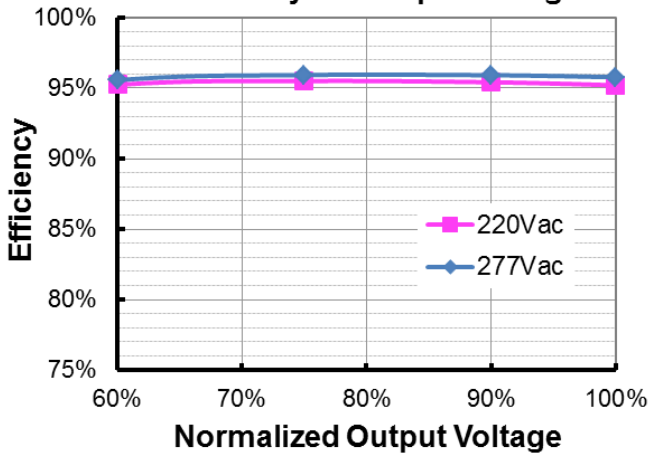

EBM-1K2S350MG (Io=3500mA)
Efficiency vs. Output Voltage

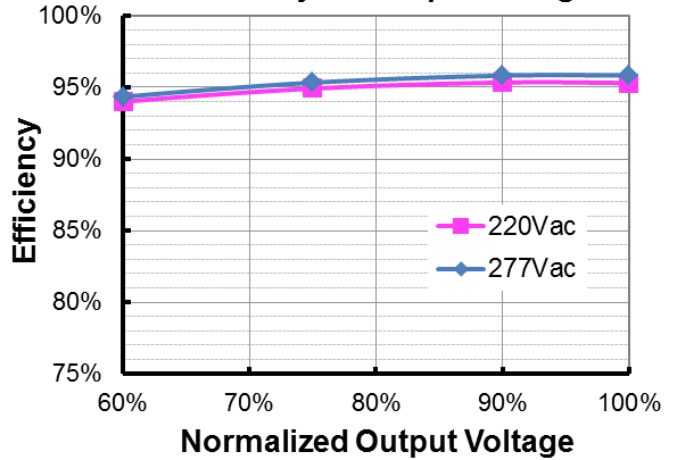

EBM-1K2S525MG (Io=3950mA)
Efficiency vs. Output Voltage

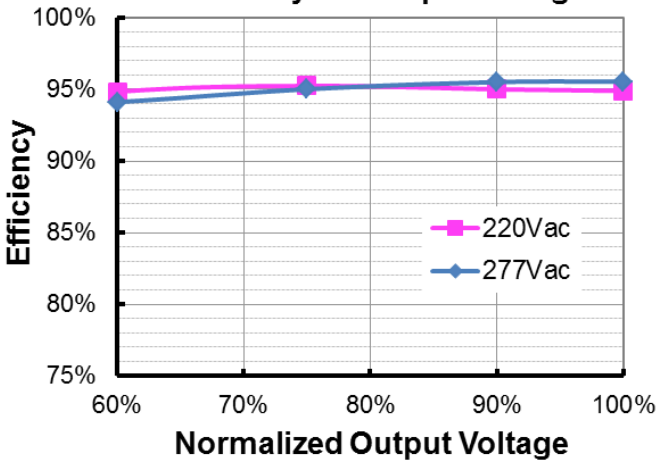

EBM-1K2S525MG (Io=5250mA)
Efficiency vs. Output Voltage

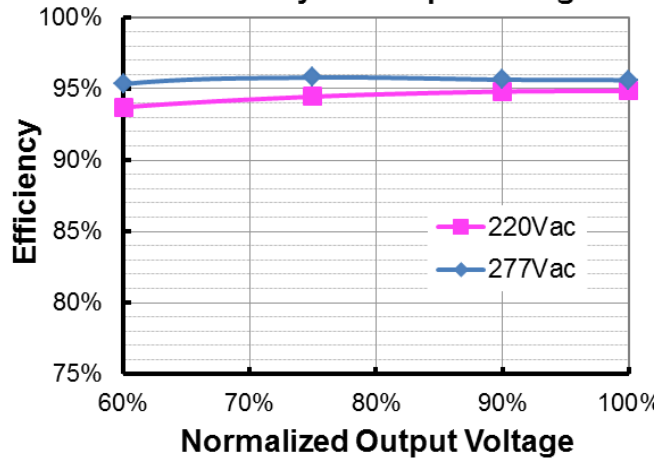

EBM-1K2S740MG (Io=5550mA)
Efficiency vs. Output Voltage

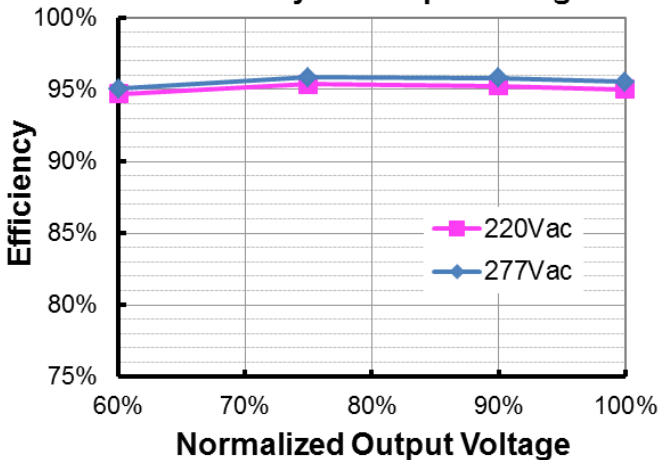

EBM-1K2S740MG (Io=7400mA)
Efficiency vs. Output Voltage

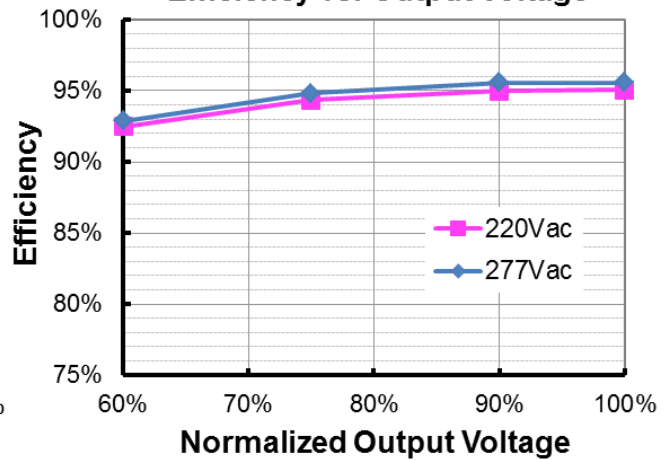

Power Factor

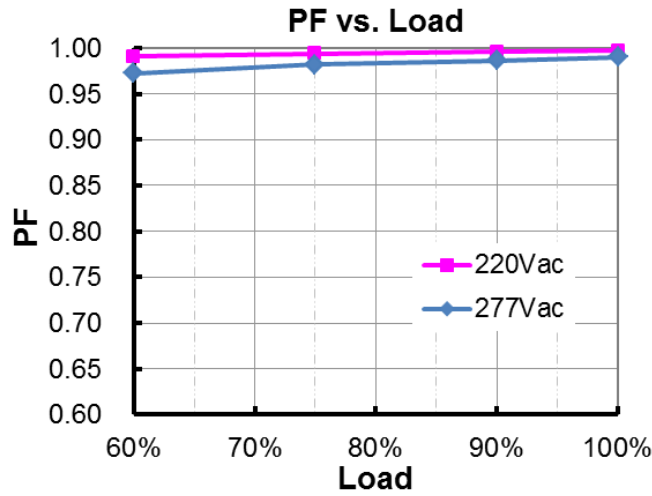

Total Harmonic Distortion

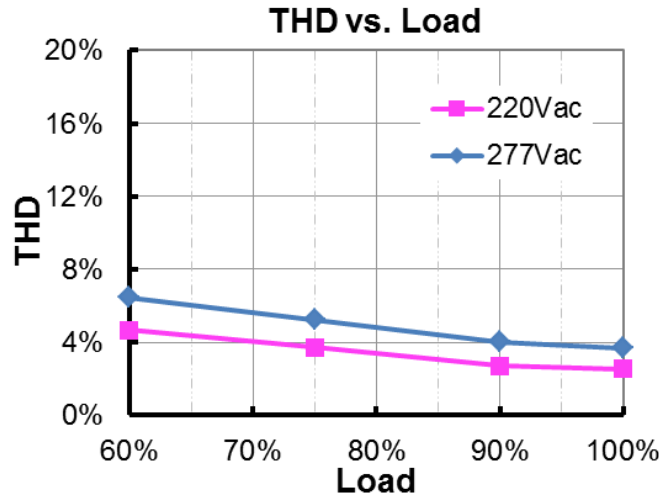

Protection Functions

Parameter		Min.	Typ.	Max.	Notes
Over Voltage Protection		Limits output voltage at no load and in case the normal voltage limit fails.			
Short Circuit Protection		Auto Recovery. No damage will occur when any output is short circuited. The output shall return to normal when the fault condition is removed.			
Over Temperature Protection		Decreases output current, returning to normal after over temperature is removed.			
Input Under Voltage Protection (IUVP)	Input Protection Voltage	135 Vac	145 Vac	155 Vac	Turn off the output when the input voltage falls below protection voltage.
	Input Recovery Voltage	155 Vac	165 Vac	175 Vac	Auto Recovery. The driver will restart when the input voltage exceeds recovery voltage.
Input Over Voltage Protection (IOVP)	Input Over Voltage Protection	310 Vac	320 Vac	330 Vac	Turn off the output when the input voltage exceeds protection voltage.
	Input Over Voltage Recovery	300 Vac	310 Vac	320 Vac	Auto Recovery. The driver will restart when the input voltage falls below recovery voltage.
	Max. of Input Over Voltage	-	-	350 Vac	The driver can survive for 48 hours with input voltage stress of 350Vac.

● **Input Under Voltage Protection Diagram**

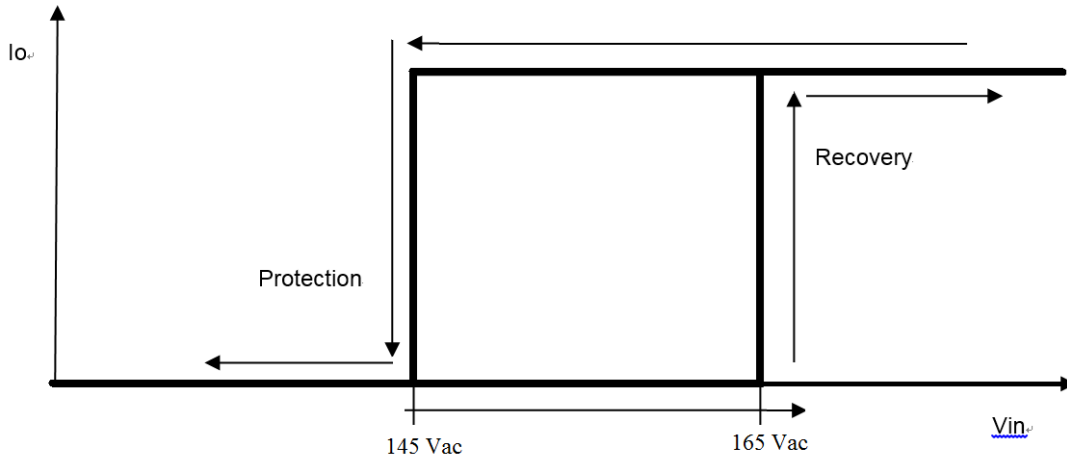

● **Input Over Voltage Protection Diagram**

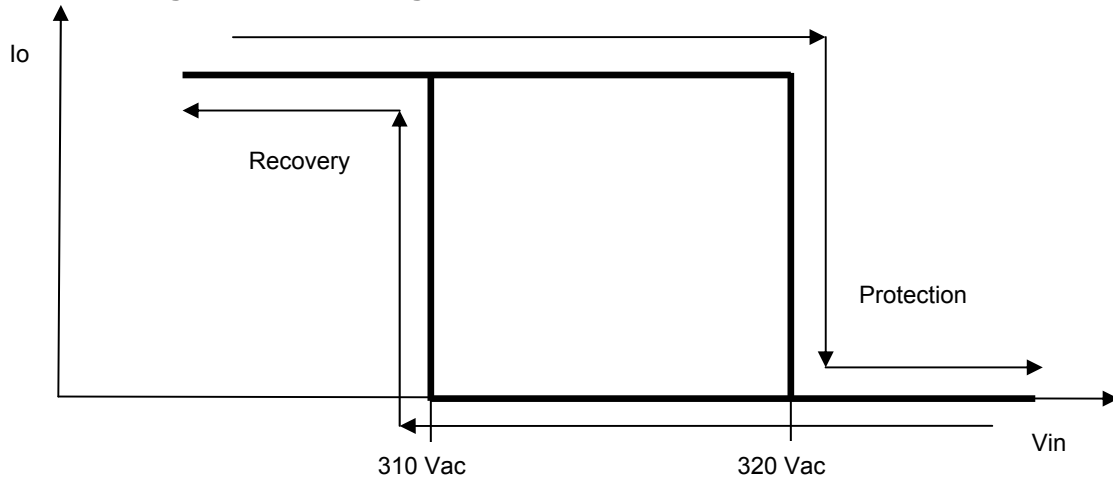

Dimming

● **0-10V Dimming**

The recommended implementation of the dimming control is provided below.

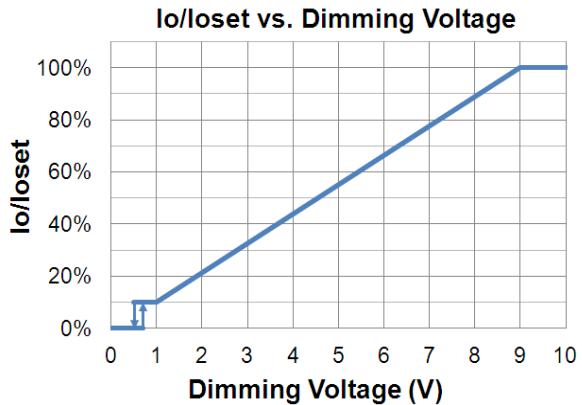
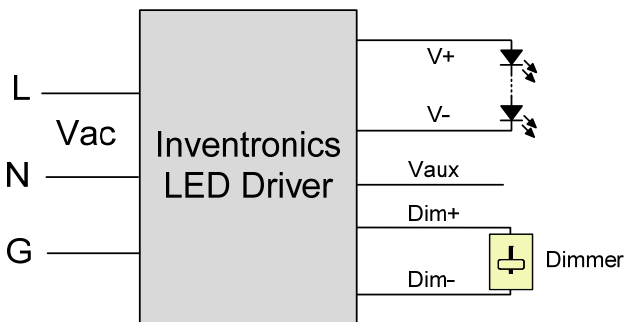

Implementation 1: Positive logic

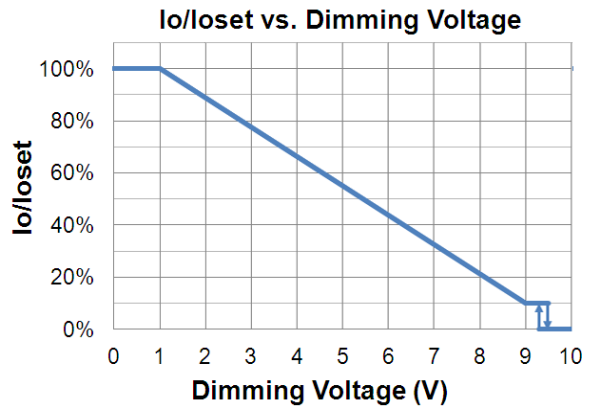
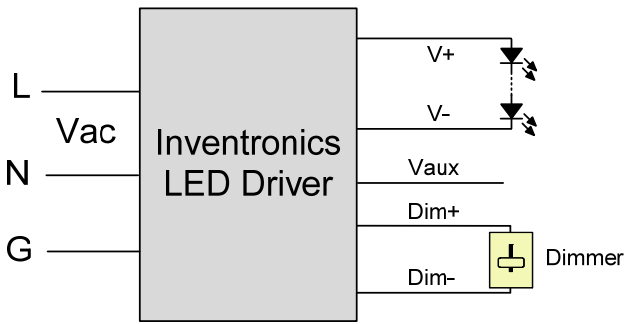

Implementation 2: Negative logic

Notes:

1. Do NOT connect Dim- to the output V- or V+, otherwise the driver will not work properly.
2. The dimmer can also be replaced by an active 0-10V voltage source signal or passive components like zener.
3. When 0-10V negative logic dimming mode and Dim+ is open, the driver will dim to off and be standby.

● PWM Dimming

The recommended implementation of the dimming control is provided below.

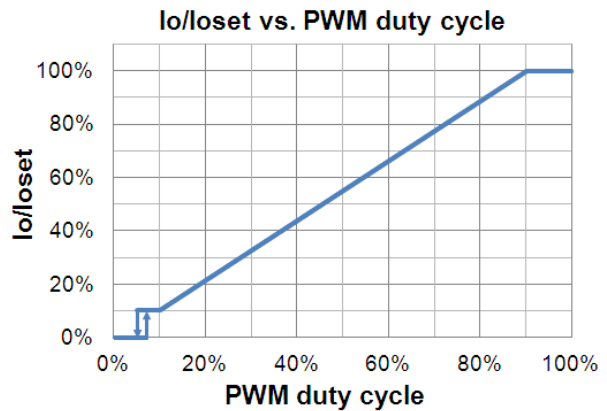
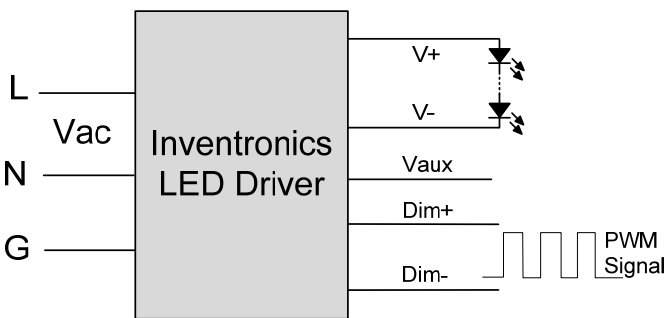

Implementation 3: Positive logic

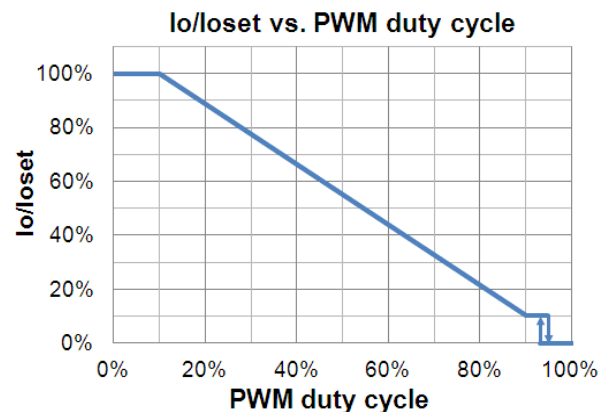
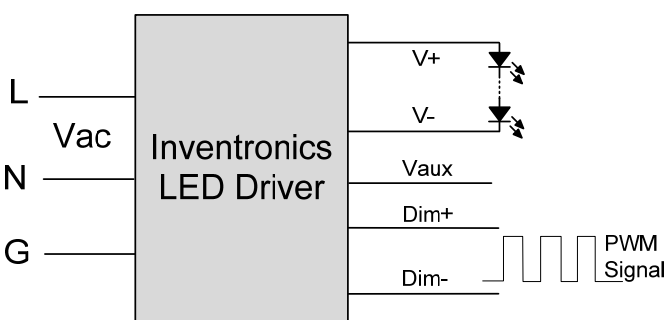

Implementation 4: Negative logic

Notes:

1. Do NOT connect Dim- to the output V- or V+, otherwise the driver will not work properly.
2. When PWM negative logic dimming mode and Dim+ is open, the driver will dim to off and be standby.

● Time Dimming

Time dimming control includes 3 kinds of modes, they are Self Adapting-Midnight, Self Adapting-Percentage and Traditional Timer.

- **Self Adapting-Midnight:** Automatically adjusts the dimming curve based on the on-time of past two days (if difference <15 minutes), assuming that the center point of the dimming curve is midnight local time.
- **Self Adapting-Percentage:** Automatically adjusts the on-time of each step by a constant percentage = (actual on-time for the past 2 days if difference <15 min) / (programmed on-time from the dimming curve).
- **Traditional Timer:** Follows the programmed timing curve after power on with no changes.

● Output Lumen Compensation

Output Lumen Compensation (OLC) may be used to maintain constant light output over the life of the LEDs by driving them at a reduced current when new, then gradually increasing the drive current over time to counteract LED lumen degradation.

● End Of Life

End-of-Life (EOL) is providing a visual notification to a user that the LED module has reached the end of manufacturer-specified life and that the replacement is recommended. Once active, an indication is given at each power-up of the driver, which the driver indicates this through a lower light output during the first 1 minute before normal operation is continued.

● Digital Dimming

Inventronics Digital Dimming is a UART (Universal Asynchronous Receive Transmitter) based communication protocol. Please refer to [Inventronics Digital Dimming](#) file for details.

Programming Connection Diagram

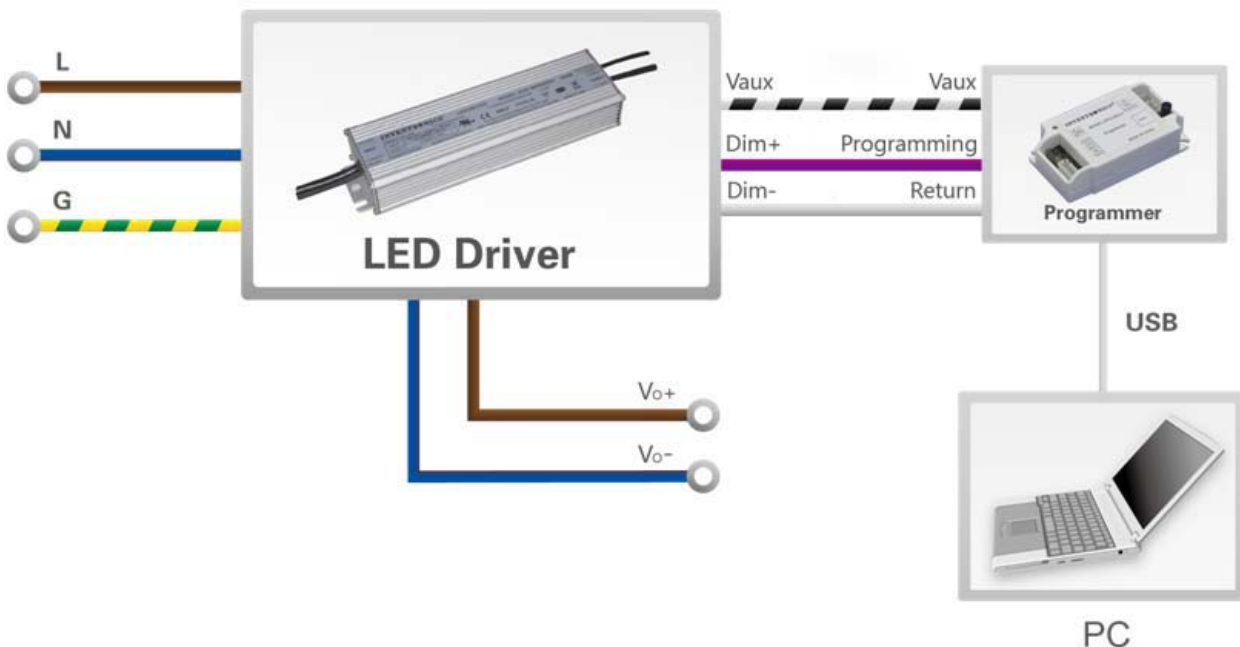

Note: The driver does not need to be powered on during the programming process.

- Please refer to [PRG-MUL2 \(Programmer\) datasheet](#) for details.

Mechanical Outline

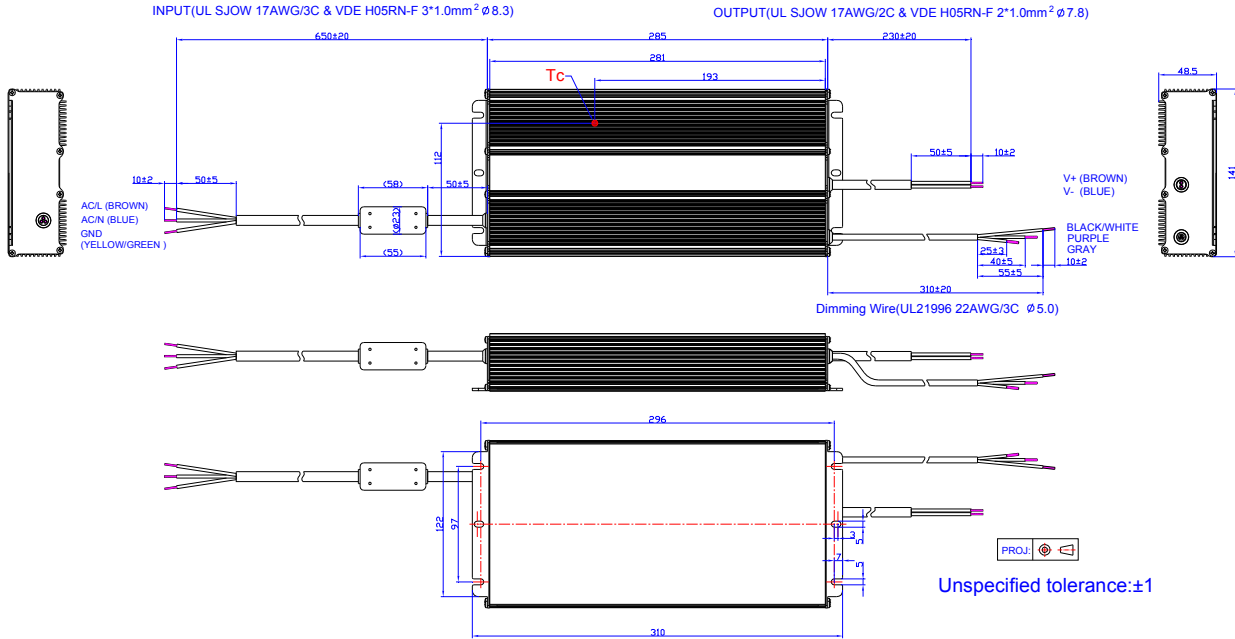

RoHS Compliance

Our products comply with reference to RoHS Directive (EU) 2015/863 amending 2011/65/EU, calling for the elimination of lead and other hazardous substances from electronic products.

Revision History

Change Date	Rev.	Description of Change		
		Item	From	To
2020-12-25	A	Datasheet Release	/	/
2020-12-30	B	Features	/	updated
		Safety &EMC Compliance	/	updated
2021-02-05	C	Features	/	updated
		Input Specifications	Leakage Current	updated