

Features

- Full Power at Wide Output Current Range (Constant Power)
- Adjustable Output Current (AOC) with NFC
- Isolated 0-10V/PWM/3-Timer-Modes Dimmable
- INV Digital Dimming, UART Based Communication Protocol Compliant with T/CSA-051
- Dim-to-Off with Standby Power
- Always-on Auxiliary Power: 12Vdc,250mA,3W (Transient Peak Power up to 10W)
- Low Inrush Current
- Integrated Power Metering with High Accuracy up to $\pm 1\%$
- Output Lumen Compensation
- End-of-Life Indicator
- Thermal Sensing and Protection for LED Module
- Input Surge Protection: DM 6kV, CM 10kV
- All-Around Protection: IUVP, IOVP, OVP, SCP, OTP
- IP66 / IP67 and UL Dry / Damp / Wet Location
- TYPE HL, for use in a Class I, Division 2 hazardous (Classified) location
- 5 Years Warranty



Description

The ESM-240SxxxLx series is a 240W, constant-current, NFC programmable and IP66/IP67 rated LED driver that operates from 249-528Vac input with excellent power factor. Created for smart lighting and health monitoring applications, this family provides integrated AC power monitoring with an auxiliary voltage and dim-to-off functionality for powering low voltage, wireless controls. The dimming control supports 0-10V dimming as well as two-way communication via Digital Dimming, a UART based communication protocol that complies with T/CSA-051. The high efficiency of these drivers and compact metal case enables them to run cooler, significantly improving reliability and extending product life. To ensure trouble-free operation, protection is provided against input surge, input under voltage, input over voltage, output over voltage, short circuit, and over temperature.

Models

Adjustable Output Current Range	Full-Power Current Range (1)	Default Output Current	Input Voltage Range(2)	Output Voltage Range	Max. Output Power	Typical Efficiency (3)	Typical Power Factor		Model Number (5)
							277Vac	480Vac	
70-1050mA	700-1050mA	700 mA	249~528 Vac/ 352~500 Vdc	115~343Vdc	240W	94.0%	0.99	0.96	ESM-240S105Lx
105-1500mA	1050-1500mA	1050 mA	249~528 Vac/ 352~500 Vdc	80~229 Vdc	240W	93.5%	0.99	0.96	ESM-240S150Lx
215-3500mA	2150-3500mA	2150 mA	249~528 Vac/ 352~500 Vdc	35~111 Vdc	240W	93.0%	0.99	0.96	ESM-240S350Lx ⁽⁴⁾
420-6700mA	4200-6700mA	4900 mA	249~528 Vac/ 352~500 Vdc	18 ~ 57 Vdc	240W	92.5%	0.99	0.96	ESM-240S670Lx ⁽⁴⁾

Notes: (1) Output current range with constant power at 240W

(2) Certified input voltage range: 277-480Vac.

(3) Measured at 100% load and 480Vac input (see below "General Specifications" for details).

(4) SELV Output.

(5)) x = G are UL Recognized, ENEC and CCC, etc. models; x = T are UL Class P models.

I-V Operation Area

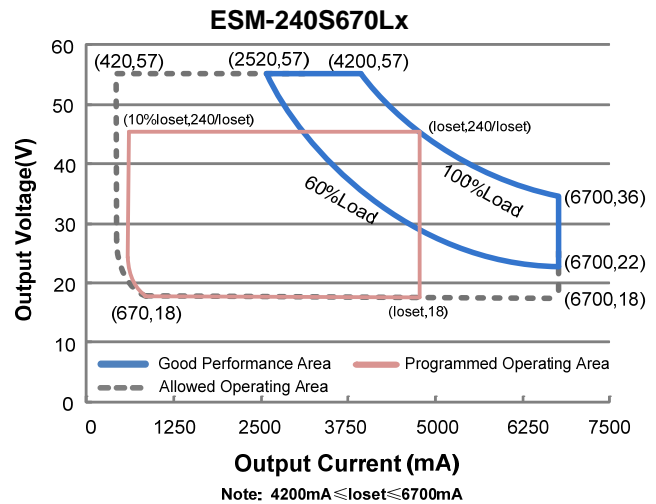
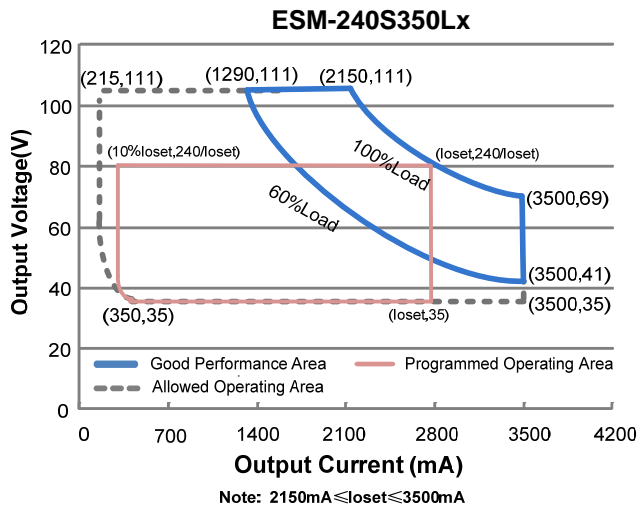
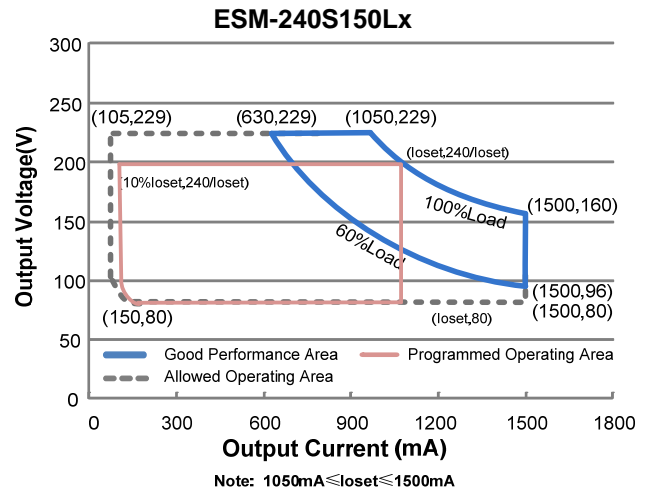
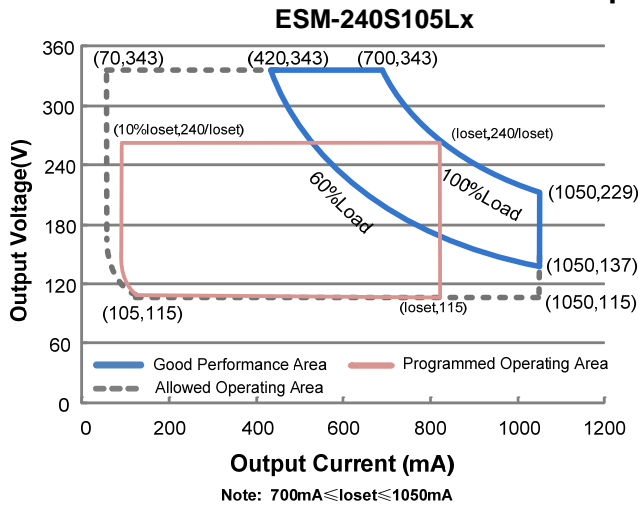

Input Specifications

Parameter	Min.	Typ.	Max.	Notes
Input AC Voltage	249 Vac	-	528 Vac	
Input DC Voltage	352 Vdc	-	500 Vdc	
Input Frequency	47 Hz	-	63 Hz	
Leakage Current	-	-	0.75 MIU	UL8750; 480Vac/ 60Hz
	-	-	0.70 mA	IEC60598-1; 480Vac/ 60Hz,
Input AC Current	-	-	1.10 A	Measured at 100% load and 277 Vac input.
	-	-	0.65 A	Measured at 100% load and 480 Vac input.
Inrush Current(I ² t)	-	-	2.10 A ² s	At 480Vac input, 25°C cold start, duration=520 μs, 10%Ipk-10%Ipk. See Inrush Current Waveform for the details.

Input Specifications (Continued)

Parameter	Min.	Typ.	Max.	Notes
PF	0.9	-	-	At 277-480Vac, 50-60Hz, 60%-100% Load (144-240W)
THD	-	-	20%	

Output Specifications

Parameter	Min.	Typ.	Max.	Notes
Output Current Tolerance	-5%loset	-	5%loset	At 100% load condition
Output Current Setting(loset) Range				
ESM-240S105Lx	70 mA	-	1050 mA	
ESM-240S150Lx	105 mA	-	1500 mA	
ESM-240S350Lx	215 mA	-	3500 mA	
ESM-240S670Lx	420 mA	-	6700 mA	
Output Current Setting Range with Constant Power				
ESM-240S105Lx	700 mA	-	1050 mA	
ESM-240S150Lx	1050 mA	-	1500 mA	
ESM-240S350Lx	2150 mA	-	3500 mA	
ESM-240S670Lx	4200 mA	-	6700 mA	
Total Output Current Ripple (pk-pk)	-	5%lomax	10%lomax	At 100% load condition. 20 MHz BW
Output Current Ripple at < 200 Hz (pk-pk)	-	2%lomax	-	At 100% load condition. Only this component of ripple is associated with visible flicker.
Startup Overshoot Current	-	-	10%lomax	At 100% load condition
No Load Output Voltage				
ESM-240S105Lx	-	-	400 V	
ESM-240S150Lx	-	-	290 V	
ESM-240S350Lx	-	-	120 V	
ESM-240S670Lx	-	-	75 V	
Line Regulation	-	-	±0.5%	Measured at 100% load
Load Regulation	-	-	±3.0%	
Turn-on Delay Time	-	-	0.5 s	Measured at 277-480Vac input, 60%-100% Load
Temperature Coefficient of loset	-	0.03%/°C	-	Case temperature = 0°C ~Tc max
12V Auxiliary Output Voltage	10.8 V	12 V	13.2 V	
12V Auxiliary Output Source Current	0 mA	-	250 mA	Return terminal is "Dim"
12V Auxiliary Output Transient Peak Current	-	-	850 mA	850mA peak for a maximum duration of 1.3 ms in a 5.2 ms period during which time the average should not exceed 250mA.

General Specifications

Parameter	Min.	Typ.	Max.	Notes	
Efficiency at 277 Vac input: ESM-240S105Lx I _o = 700 mA I _o =1050 mA ESM-240S150Lx I _o =1050 mA I _o =1500 mA ESM-240S350Lx I _o =2150 mA I _o =3500 mA ESM-240S670Lx I _o =4200 mA I _o =6700 mA	90.5% 91.0% 90.0% 90.0% 90.0% 88.5% 89.5% 87.5%	92.5% 93.0% 92.0% 92.0% 92.0% 90.5% 91.5% 89.5%	- - - - - - - -	Measured at 100% load and steady-state temperature in 25°C ambient; (Efficiency will be about 2.0% lower if measured immediately after startup.)	
Efficiency at 400 Vac input: ESM-240S105Lx I _o = 700 mA I _o =1050 mA ESM-240S150Lx I _o =1050 mA I _o =1500 mA ESM-240S350Lx I _o =2150 mA I _o =3500 mA ESM-240S670Lx I _o =4200 mA I _o =6700 mA	91.5% 91.5% 91.5% 91.0% 91.0% 89.5% 90.5% 88.5%	93.5% 93.5% 93.5% 93.0% 93.0% 91.5% 92.5% 90.5%	- - - - - - - -		
Efficiency at 480 Vac input: ESM-240S105Lx I _o = 700 mA I _o =1050 mA ESM-240S150Lx I _o =1050 mA I _o =1500 mA ESM-240S350Lx I _o =2150 mA I _o =3500 mA ESM-240S670Lx I _o =4200 mA I _o =6700 mA	91.5% 92.0% 91.5% 91.0% 91.0% 89.5% 90.5% 89.0%	93.5% 94.0% 93.5% 93.0% 93.0% 91.5% 92.5% 91.0%	- - - - - - - -		
Power Metering Accuracy	-1%	-	1%		At 100% load condition
Standby Power	-	1.5 W	-		Measured at 480Vac/50Hz; Dimming off
MTBF	-	203,000 Hours	-		Measured at 480Vac input, 80%Load and 25°C ambient temperature (MIL-HDBK-217F)
Lifetime	-	106,000 Hours	-		Measured at 480Vac input, 80%Load and 70°C case temperature; See lifetime vs. T _c curve for the details
Operating Case Temperature for Safety T _{c_s}	-40°C	-	+90°C		
Operating Case Temperature for Warranty T _{c_w}	-40°C	-	+80°C		Case temperature for 5 years warranty Humidity: 10% RH to 95% RH;
Storage Temperature	-40°C	-	+85°C		Humidity: 5%RH to 95%RH

General Specifications (Continued)

Parameter	Min.	Typ.	Max.	Notes
Dimensions Inches (L x W x H) Millimeters (L x W x H)		7.91 x 3.01 x 1.52 201 x 76.5 x 38.5		With mounting ear 8.58 x 3.01 x 1.52 218 x 76.5 x 38.5
Net Weight	-	1200 g	-	

Dimming Specifications

Parameter	Min.	Typ.	Max.	Notes	
Absolute Maximum Voltage on the Vdim (+) Pin	-20 V	-	20 V		
Source Current on Vdim (+)Pin	200 uA	300 uA	450 uA	Vdim(+) = 0 V	
Dimming Output Range	ESM-240S105Lx ESM-240S150Lx ESM-240S350Lx ESM-240S670Lx	10%loset	-	loset	700 mA ≤ loset ≤ 1050 mA 1050 mA ≤ loset ≤ 1500 mA 2150 mA ≤ loset ≤ 3500 mA 4200 mA ≤ loset ≤ 6700 mA
	ESM-240S105Lx ESM-240S150Lx ESM-240S350Lx ESM-240S670Lx	70 mA 105 mA 215 mA 420 mA	-	loset	70 mA ≤ loset < 700 mA 105 mA ≤ loset < 1050 mA 215 mA ≤ loset < 2150 mA 420 mA ≤ loset < 4200 mA
Recommended Dimming Input Range	0 V	-	10 V	Default 0-10V dimming mode.	
Dim off Voltage	0.35 V	0.5 V	0.65 V		
Dim on Voltage	0.55 V	0.7 V	0.85 V		
Hysteresis	-	0.2 V	-		
PWM_in High Level	3 V	-	10 V	Dimming mode set to PWM in PC interface.	
PWM_in Low Level	-0.3 V	-	0.6 V		
PWM_in Frequency Range	200 Hz	-	3 KHz		
PWM_in Duty Cycle	1%	-	99%		
PWM Dimming off (Positive Logic)	3%	5%	8%		
PWM Dimming on (Positive Logic)	5%	7%	10%		
PWM Dimming off (Negative Logic)	92%	95%	97%		
PWM Dimming on (Negative Logic)	90%	93%	95%		
Hysteresis	-	2%	-		

Safety & EMC Compliance

Safety Category	Standard
UL/CUL	UL8750,CAN/CSA-C22.2 No. 250.13
ENEC & CE	EN 61347-1, EN 61347-2-13

Safety & EMC Compliance (Continued)

Safety Category	Standard
CB	IEC 61347-1, IEC 61347-2-13
EMI Standards	Notes
EN 55015 ⁽¹⁾	Conducted emission Test & Radiated emission Test
EN 61000-3-2	Harmonic current emissions
EN 61000-3-3	Voltage fluctuations & flicker
FCC Part 15 ⁽¹⁾	ANSI C63.4 Class B
	This device complies with Part 15 of the FCC Rules. Operation is subject to the following two conditions: [1] this device may not cause harmful interference, and [2] this device must accept any interference received, including interference that may cause undesired Operation.
EMS Standards	Notes
EN 61000-4-2	Electrostatic Discharge (ESD): 8 kV air discharge, 4 kV contact discharge
EN 61000-4-3	Radio-Frequency Electromagnetic Field Susceptibility Test-RS
EN 61000-4-4	Electrical Fast Transient / Burst-EFT
EN 61000-4-5	Surge Immunity Test: AC Power Line: Differential Mode 6 kV, Common Mode 10 kV
EN 61000-4-6	Conducted Radio Frequency Disturbances Test-CS
EN 61000-4-8	Power Frequency Magnetic Field Test
EN 61000-4-11	Voltage Dips
EN 61547	Electromagnetic Immunity Requirements Applies To Lighting Equipment

Note: (1) This LED driver meets the EMI specifications above, but EMI performance of a luminaire that contains it depends also on the other devices connected to the driver and on the fixture itself.

Lifetime vs. Case Temperature

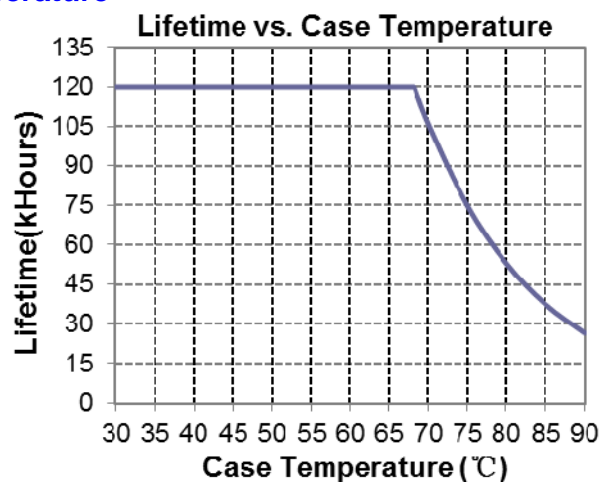

Inrush Current Waveform

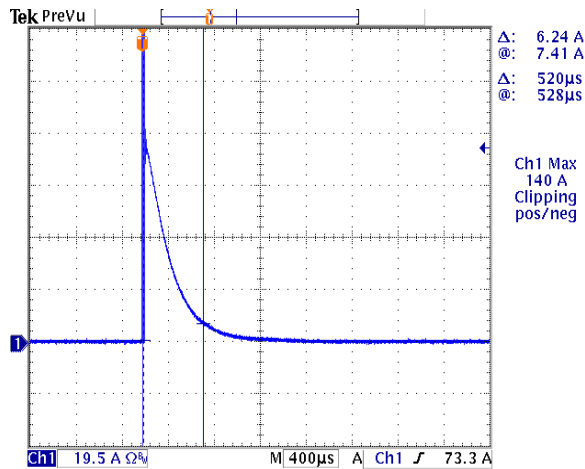

Efficiency vs. Load

ESM-240S105Lx (I_o=700mA)

Efficiency vs. Output Voltage

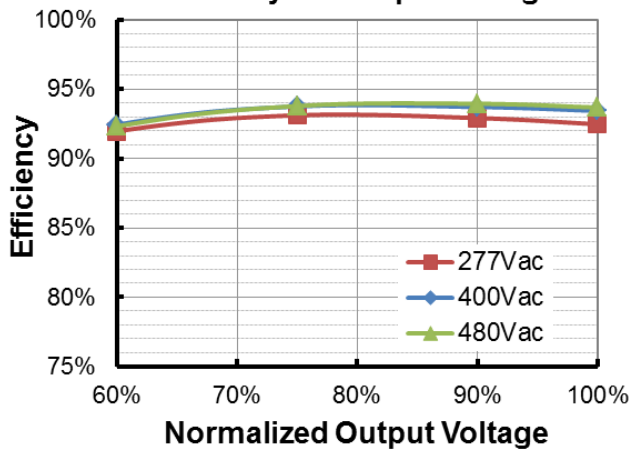

ESM-240S105Lx (I_o=1050mA)

Efficiency vs. Output Voltage

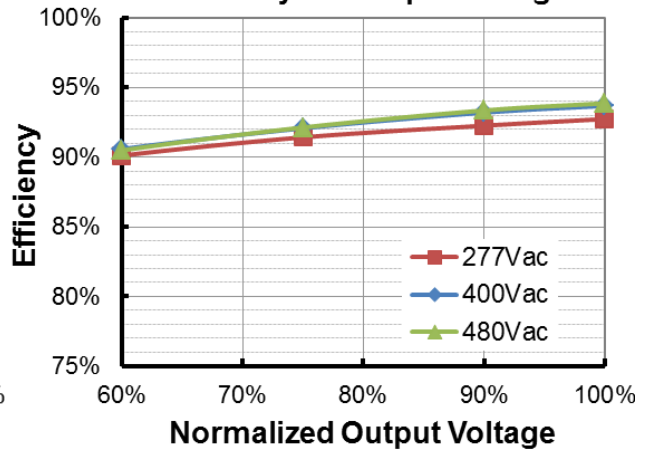

ESM-240S150Lx (I_o=1050mA)

Efficiency vs. Output Voltage

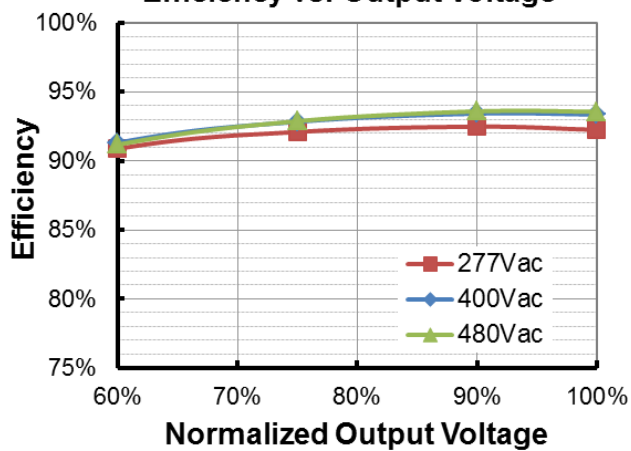

ESM-240S150Lx (I_o=1500mA)

Efficiency vs. Output Voltage

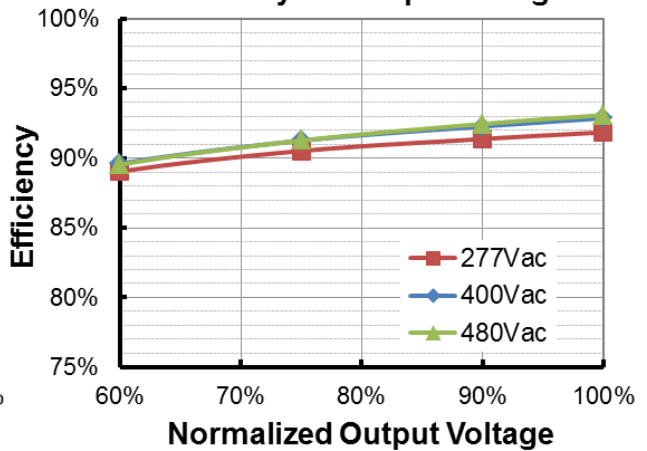

ESM-240S350Lx (Io=2150mA)
Efficiency vs. Output Voltage

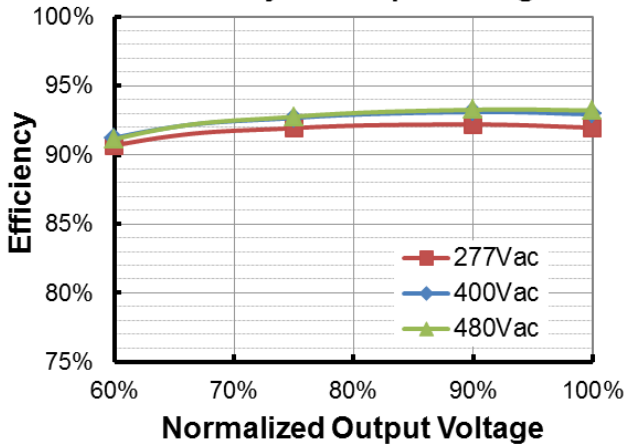

ESM-240S350Lx (Io=3500mA)
Efficiency vs. Output Voltage

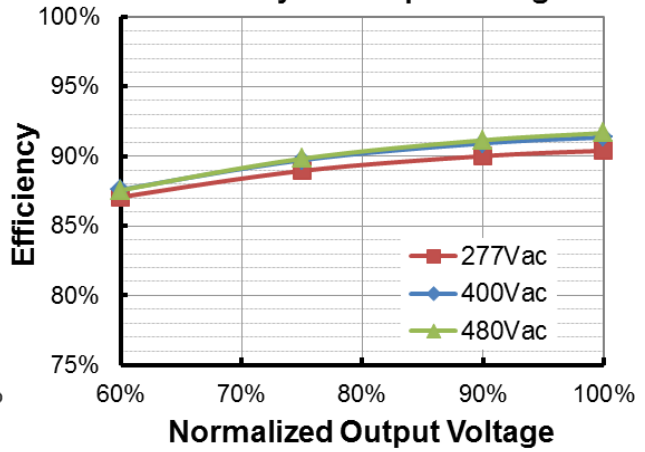

ESM-240S670Lx (Io=4200mA)
Efficiency vs. Output Voltage

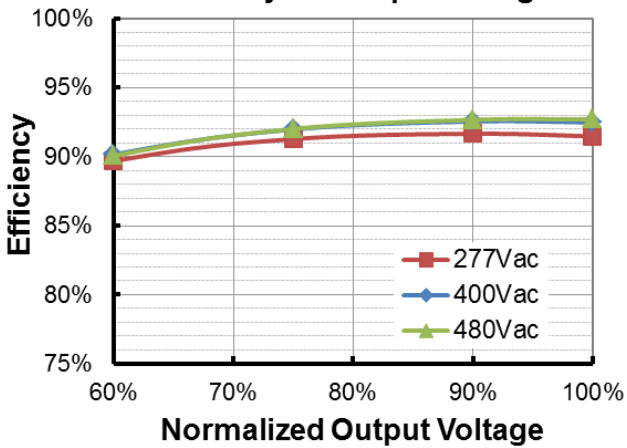

ESM-240S670Lx (Io=6700mA)
Efficiency vs. Output Voltage

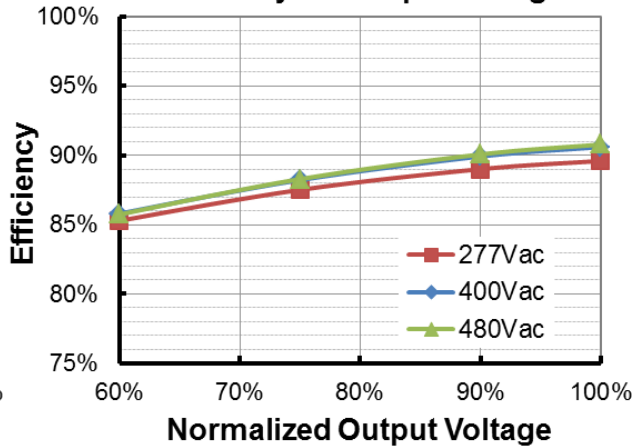

Power Factor

PF vs. Load

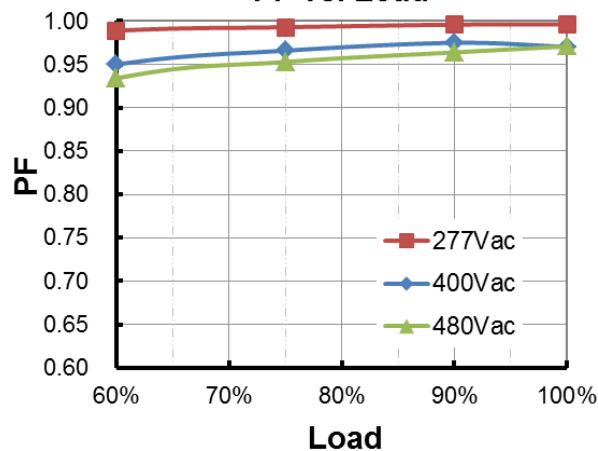

Total Harmonic Distortion

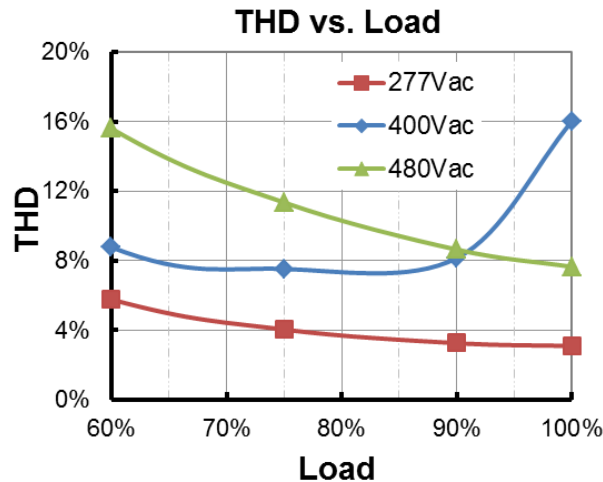

Protection Functions

Parameter		Min.	Typ.	Max.	Notes
External Thermal Protection	R1 (Start derating)	-	1.67 kΩ	-	The output current starts to decrease linearly when the actual NTC resistance value is lower than R1, until R2 is reached.
	R2 (Stop derating)	-	1.27 kΩ	-	When the actual NTC resistance value is lower than R2, the output current will stay at the programmed Protection Current Floor.
	Protection Current Floor	10% <i>I</i> _{oSet}	20% <i>I</i> _{oSet}	100% <i>I</i> _{oSet}	10% <i>I</i> _{oSet} > <i>I</i> _{oMin} (default setting is 20%) 10% <i>I</i> _{oSet} ≤ <i>I</i> _{oMin} (default setting is 20%)
Over Temperature Protection		Decreases output current, returning to normal after over temperature is removed.			
Short Circuit Protection		Auto Recovery. No damage will occur when any output is short circuited. The output shall return to normal when the fault condition is removed.			
Over Voltage Protection		Limits output voltage at no load and in case the normal voltage limit fails.			
Input Under Voltage Protection (IUVP)	Input Protection Voltage	220 Vac	230 Vac	240 Vac	Turn off the output when the input voltage exceeds protection voltage.
	Recovery Voltage	230 Vac	240 Vac	250 Vac	Auto Recovery. The driver will restart when the input voltage falls below recovery voltage.
Input Over Voltage Protection	Input Over Voltage Protection	550 Vac	570 Vac	590 Vac	Turn off the output when the input voltage exceeds protection voltage.
	Input Over Voltage Recovery	530 Vac	550 Vac	570 Vac	Auto Recovery. The driver will restart when the input voltage falls below recovery voltage.
	Max. of Input Over Voltage	-	-	590 Vac	The driver can survive for 8 hours with input voltage stress of 590Vac.

Note: (1) The recommended NTC type is 10kΩ NTC, Murata NCP18XH103J03RB.

● **Input Under Voltage Protection Diagram**

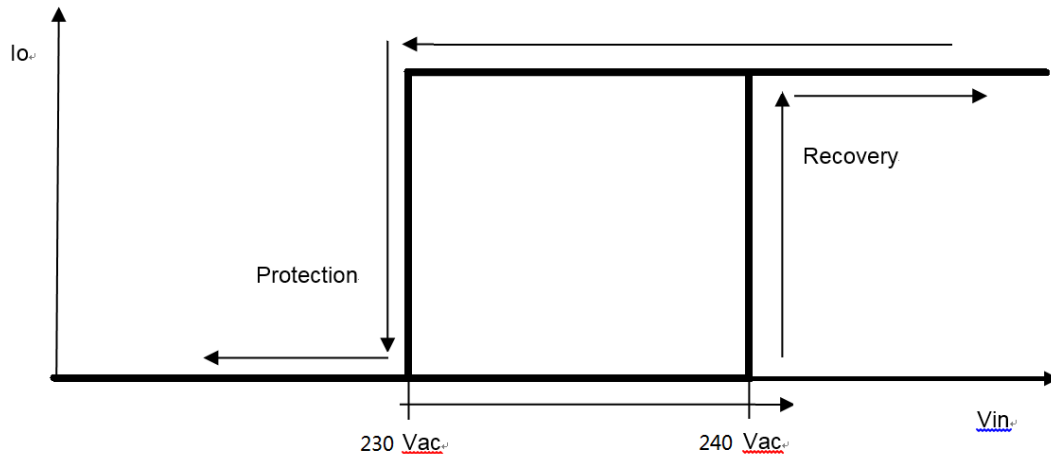

● **Input Over Voltage Protection Diagram**

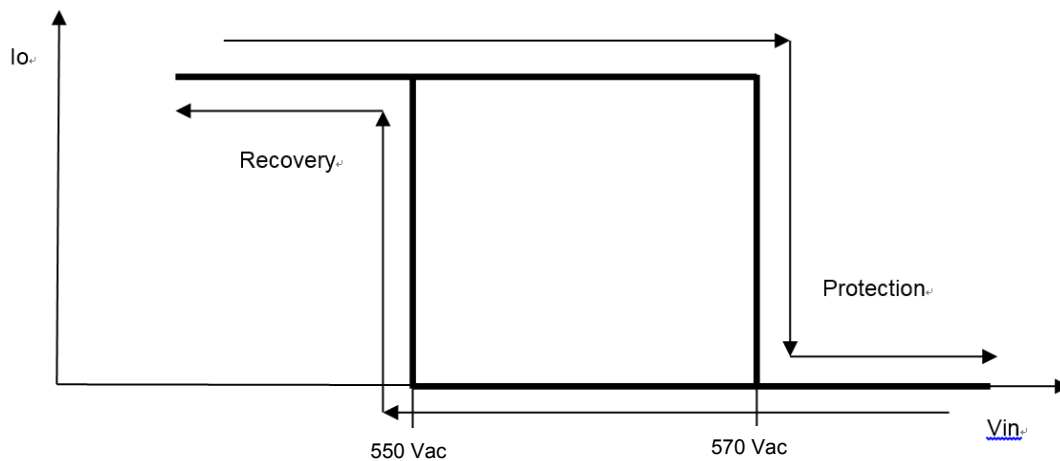

Dimming

● **0-10V Dimming**

The recommended implementation of the dimming control is provided below.

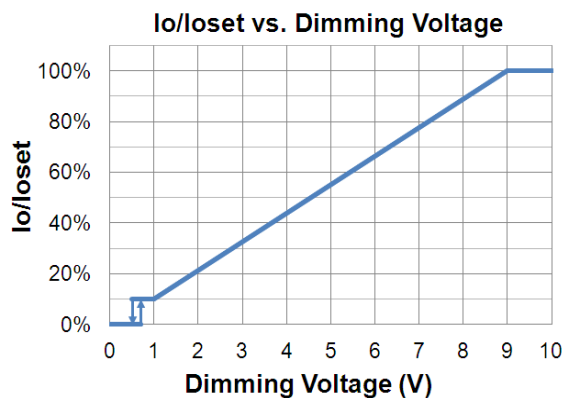
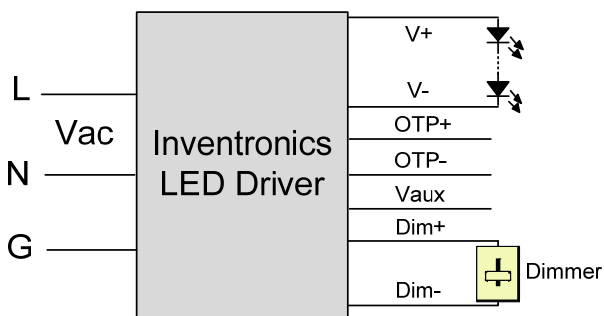

Implementation 1: Positive logic

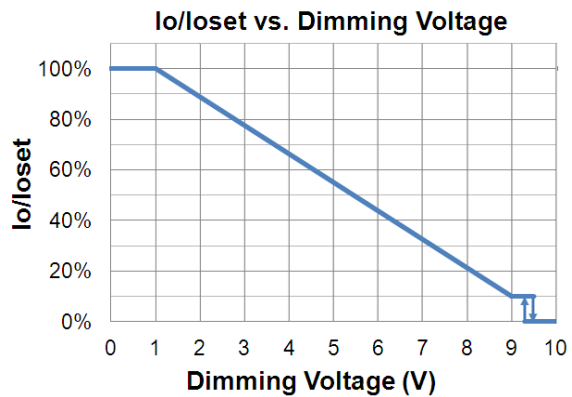
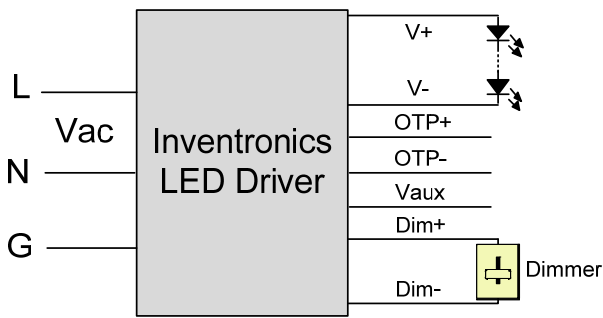

Implementation 2: Negative logic

Notes:

1. Do NOT connect Dim- to the output V- or V+, otherwise the driver will not work properly.
2. The dimmer can also be replaced by an active 0-10V voltage source signal or passive components like zener.
3. When 0-10V negative logic dimming mode and Dim+ is open, the driver will dim to off and be standby.

● **PWM Dimming**

The recommended implementation of the dimming control is provided below.

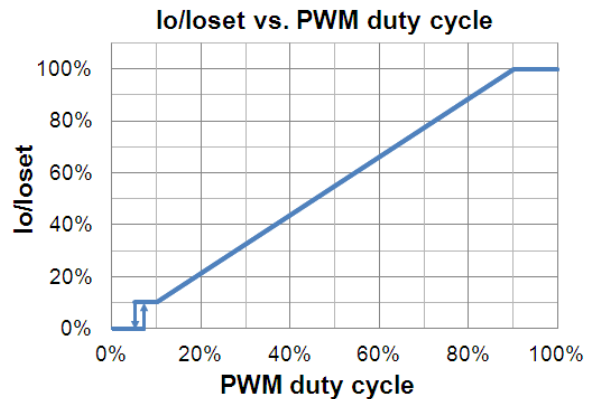
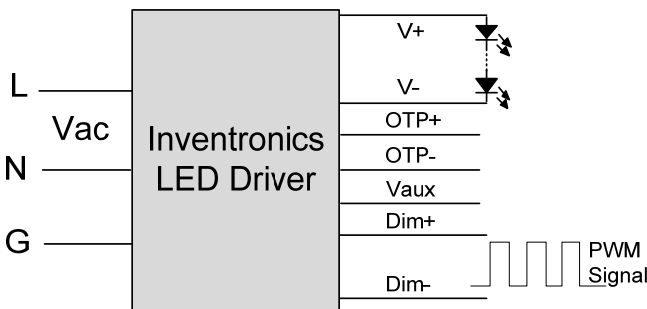

Implementation 3: Positive logic

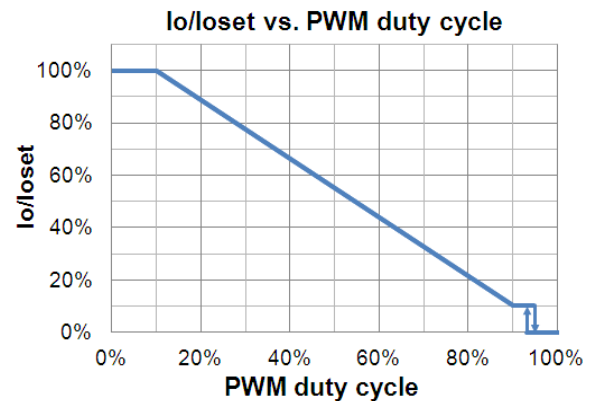
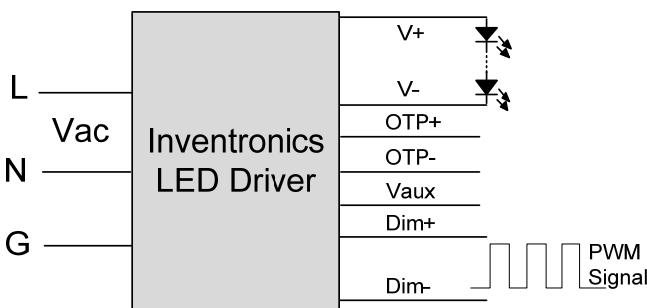

Implementation 4: Negative logic

Notes:

1. Do NOT connect Dim- to the output V- or V+, otherwise the driver will not work properly.
2. When PWM negative logic dimming mode and Dim+ is open, the driver will dim to off and be standby.

● **Time Dimming**

Time dimming control includes 3 kinds of modes, they are Self Adapting-Midnight, Self Adapting-Percentage and Traditional Timer.

- **Self Adapting-Midnight:** Automatically adjusts the dimming curve based on the on-time of past two days (if difference <15 minutes), assuming that the center point of the dimming curve is midnight local time.
- **Self Adapting-Percentage:** Automatically adjusts the on-time of each step by a constant percentage = (actual on-time for the past 2 days if difference <15 min) / (programmed on-time from the dimming curve).
- **Traditional Timer:** Follows the programmed timing curve after power on with no changes.

● **Output Lumen Compensation**

Output Lumen Compensation (OLC) may be used to maintain constant light output over the life of the LEDs by driving them at a reduced current when new, then gradually increasing the drive current over time to counteract LED lumen degradation.

● **End Of Life**

End-of-Life (EOL) is providing a visual notification to a user that the LED module has reached the end of manufacturer-specified life and that the replacement is recommended. Once active, an indication is given at each power-up of the driver, which the driver indicates this through a lower light output during the first 1 minute before normal operation is continued.

● **Digital Dimming**

Inventronics Digital Dimming is a UART (Universal Asynchronous Receive Transmitter) based communication protocol and is compliant with T/CSA-051 standard. Please refer to [Inventronics Digital Dimming](#) file for details.

Programming Connection Diagram

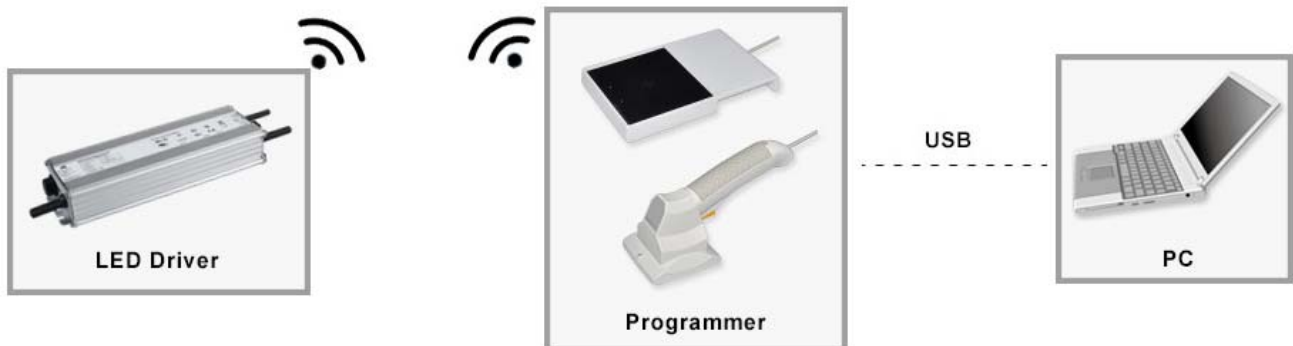

Note: The driver does not need to be powered on during the programming process.

- Please refer to [PRG-NFC-H](#) or [PRG-NFC-D](#) (Programmer) datasheet for details.

Mechanical Outline

ESM-240SxxxLG

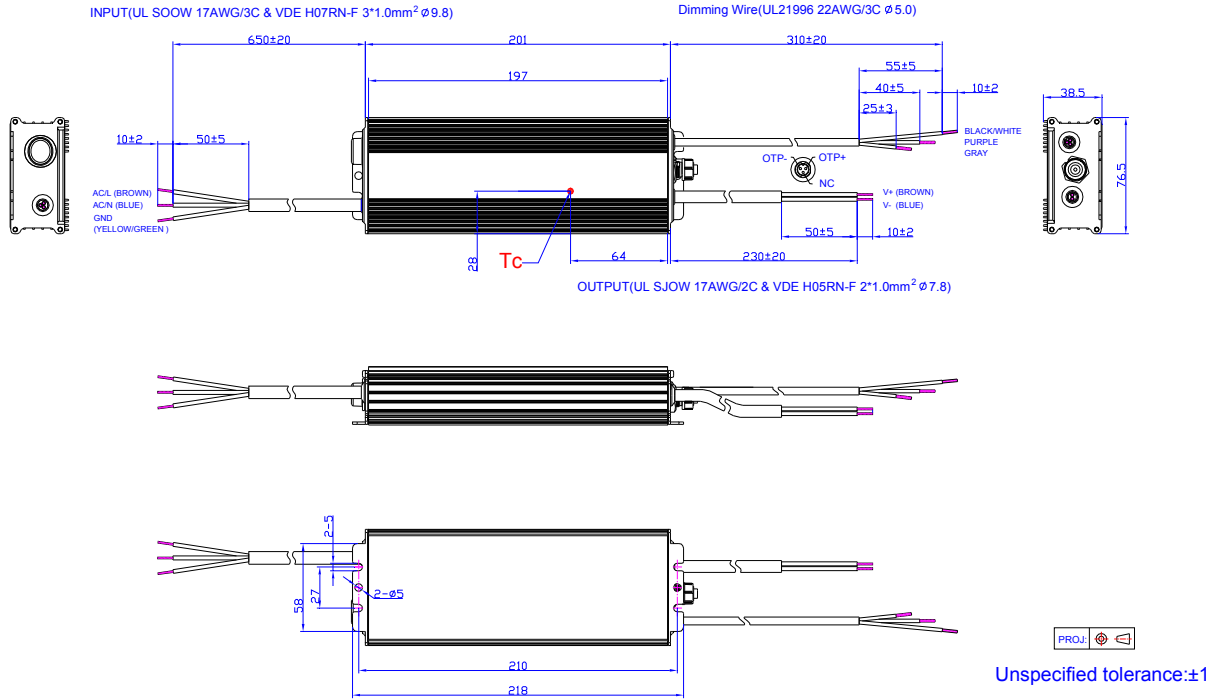

ESM-240SxxxLT

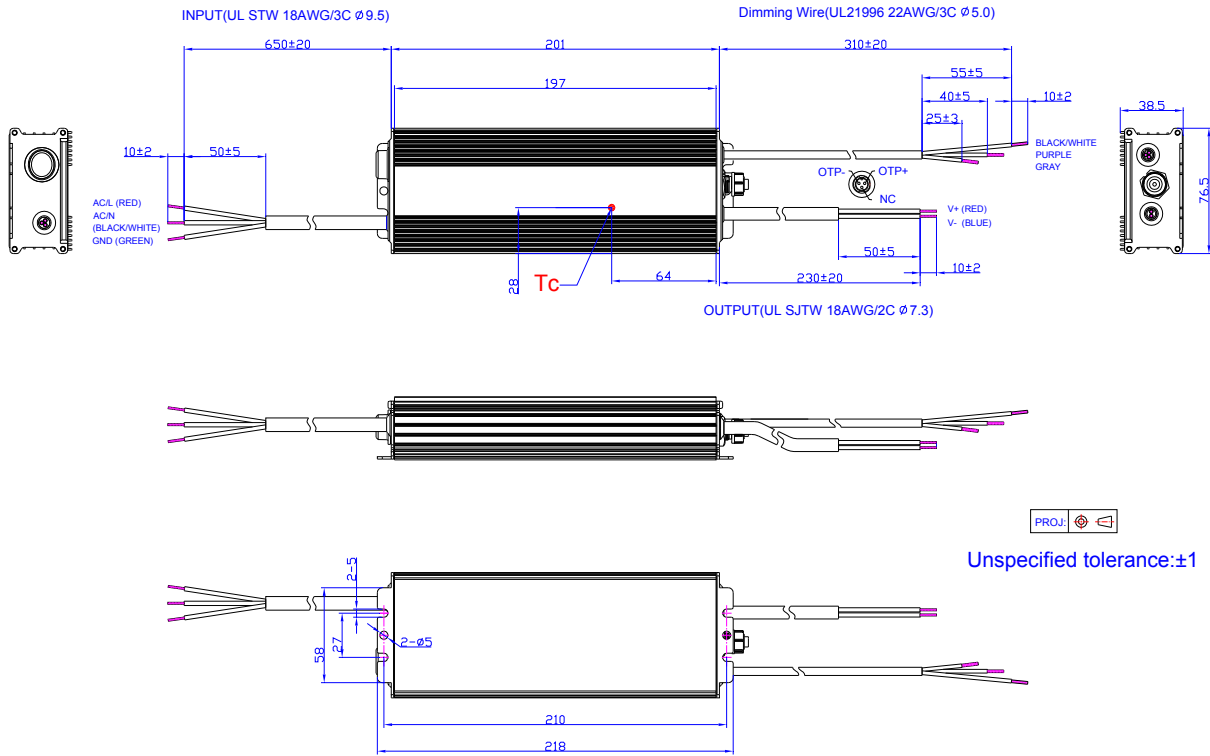

RoHS Compliance

Our products comply with reference to RoHS Directive (EU) 2015/863 amending 2011/65/EU, calling for the elimination of lead and other hazardous substances from electronic products.

Revision History

Change Date	Rev.	Description of Change		
		Item	From	To
2021-03-25	A	Datasheets Created	/	/