

## Features

- Adjust color temperature continuously
- Adjust intensity and color temperature separately
- 60W Max each channel with total 60W load
- 1% Min each channel with total 10% Min dimming
- Full Power at Wide Output Current Range (Constant Power)
- Adjustable Output Current (AOC) with Programmability
- Isolated 1-5V/1-10V/10V PWM/3-Timer-Modes Dimmable
- Flicker free
- Output Lumen Compensation
- Input Surge Protection: DM 4kV, CM 6kV
- All-Around Protection: OVP, SCP, OTP
- IP66 / IP67 (DV model)  
IP66 and UL Dry / Damp Location (DF model)
- SELV Output
- TYPE HL, for use in a Class I, Division 2 hazardous (Classified) location
- 5 Years Warranty



## Description

The EUW-060DxxxDx series is a 60W, constant-current, programmable IP66/IP67 LED driver that operates from 90-305Vac input with excellent power factor. Created to enhance tunnel, low bay, signage, or wall pack type applications by offering a simplified white color tuning solution. The high efficiency of these drivers and compact metal case enables them to run cooler, significantly improving reliability and extending product life. To ensure trouble-free operation, protection is provided against input surge, output over voltage, short circuit, and over temperature.

## Models

Adjustable Output Current Range	Full-Power Current Range (1)	Default Output Current	Input Voltage Range(2)	Output Voltage Range	Max. Output Power	Typical Efficiency (3)	Typical Power Factor		Model Number (4)
							120Vac	220Vac	
7-1050mA	700-1050mA	700 mA	90~305 Vac/ 127~300 Vdc	28~86 Vdc	60W	89.0%	0.99	0.96	EUW-060D105Dx

- Notes:** (1) Output current range with constant power at 60W  
 (2) Certified input voltage range: UL, FCC 100-277Vac; otherwise 100-240Vac  
 (3) Measured at 100% load and 220Vac input (see below "General Specifications" for details)  
 (4) SELV Output  
 (5) x = V is CCC and CE model; x = F are UL Recognized model

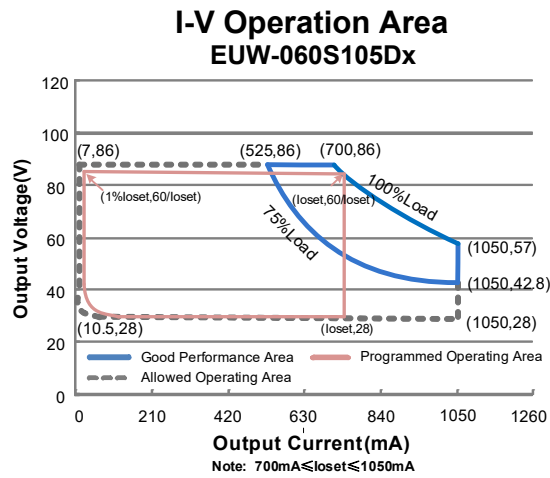

## Input Specifications

Parameter	Min.	Typ.	Max.	Notes
Input AC Voltage	90 Vac	-	305 Vac	
Input DC Voltage	127 Vdc	-	300 Vdc	
Input Frequency	47 Hz	-	63 Hz	
Leakage Current	-	-	0.75 MIU	UL8750; 277Vac/ 60Hz
	-	-	0.70 mA	IEC60598-1; 240Vac/ 60Hz,
Input AC Current	-	-	0.66 A	Measured at 100% load and 120 Vac input.
	-	-	0.35 A	Measured at 100% load and 220 Vac input.
Inrush Current(I <sup>2</sup> t)	-	-	0.01 A <sup>2</sup> s	At 220Vac input, 25°C cold start, duration=1.32 μs, 10%I <sub>pk</sub> -10%I <sub>pk</sub> . See Inrush Current Waveform for the details.
PF	0.9	-	-	At 100-277Vac, 50-60Hz, 75%-100% Load (45-60W)
THD	-	-	20%	
THD	-	-	10%	At 220-240Vac, 50-60Hz, 75%-100% Load (45-60W)

## Output Specifications

Parameter	Min.	Typ.	Max.	Notes
Output Current Tolerance	-5%loset	-	5%loset	At 100% load condition
Output Current Setting(loset) Range				
EUW-060D105Dx	7 mA	-	1050 mA	
Output Current Setting Range with Constant Power				
EUW-060D105Dx	700 mA	-	1050 mA	
Total Output Current Ripple (pk-pk)	-	5%I <sub>omax</sub>	10%I <sub>omax</sub>	At 100% load condition. 20 MHz BW

## Output Specifications (Continued)

Parameter	Min.	Typ.	Max.	Notes
Output Current Ripple at < 200 Hz (pk-pk)	-	2%I <sub>omax</sub>	-	At 100% load condition. Only this component of ripple is associated with visible flicker.
Startup Overshoot Current	-	-	10%I <sub>omax</sub>	At 100% load condition
No Load Output Voltage EUW-060S105Dx	-	-	120 V	
Line Regulation	-	-	±1%	Measured at 100% load
Load Regulation	-	-	±5%	
Turn-on Delay Time	-	-	0.5 s	Measured at 120-277Vac input, 75%-100% Load
Temperature Coefficient of I <sub>o</sub> set	-	0.06%/°C	-	Case temperature = 0°C ~T <sub>c</sub> max

## General Specifications

Parameter	Min.	Typ.	Max.	Notes
Efficiency at 120 Vac input: EUW-060S105Dx I <sub>o</sub> = 700 mA I <sub>o</sub> =1050 mA	85.0% 82.5%	87.0% 84.5%	- -	Measured at 100% load and steady-state temperature in 25°C ambient; (Efficiency will be about 2.0% lower if measured immediately after startup.)
Efficiency at 220 Vac input: EUW-060S105Dx I <sub>o</sub> = 700 mA I <sub>o</sub> =1050 mA	87.0% 84.5%	89.0% 86.5%	- -	Measured at 100% load and steady-state temperature in 25°C ambient; (Efficiency will be about 2.0% lower if measured immediately after startup.)
Efficiency at 277 Vac input: EUW-060S105Dx I <sub>o</sub> = 700 mA I <sub>o</sub> =1050 mA	86.0% 84.0%	88.0% 86.0%	- -	Measured at 100% load and steady-state temperature in 25°C ambient; (Efficiency will be about 2.0% lower if measured immediately after startup.)
MTBF	-	522,000 Hours	-	Measured at 220Vac input, 80%Load and 25°C ambient temperature (MIL-HDBK-217F)
Lifetime	-	106,000 Hours	-	Measured at 220Vac input, 80%Load and 70°C case temperature; See lifetime vs. T <sub>c</sub> curve for the details
Operating Case Temperature for Safety T <sub>c_s</sub>	-40°C	-	+90°C	
Operating Case Temperature for Warranty T <sub>c_w</sub>	-40°C	-	+80°C	Case temperature for 5 years warranty Humidity: 10%RH to 95%RH
Storage Temperature	-40°C	-	+85°C	Humidity: 5%RH to 95%RH
Dimensions Inches (L × W × H) Millimeters (L × W × H)	4.92 × 2.52 × 1.44 125 × 64 × 36.5			With mounting ear 5.59 × 2.52 × 1.44 142 × 64 × 36.5
Net Weight	-	612 g	-	

## Dimming Specifications

Parameter	Min.	Typ.	Max.	Notes	
Absolute Maximum Voltage on the Vdim (+) Pin	-20 V	-	20 V		
Source Current on Vdim (+)Pin	80 uA	130 uA	180 uA	Vdim(+) = 0 V,	
Dimming Output Range	EUW-060S105Dx	1%loset	-	loset	700 mA ≤ loset ≤ 1050 mA
	EUW-060S105Dx	7 mA	-	loset	7 mA ≤ loset < 700 mA
Recommended Dimming Range for 1-5V	0.25 V	-	4.75 V	Dimming mode set to 1-5V in PC interface.	
CCT Range for 0-5V	0	-	5		
CCT:I1 off Voltage	4.35	4.5	4.65		
CCT:I1 on Voltage	4.15	4.3	4.45		
CCT:I2 off Voltage	0.35	0.5	0.65		
CCT:I2 on Voltage	0.55	0.7	0.85		
Recommended Dimming Range for 1-10V	1 V	-	9 V	Default 1-10V dimming mode with positive logic.	
CCT Range for 0-10V	0	-	9V		
CCT:I1 off Voltage	8.35	8.5	8.65		
CCT:I1 on Voltage	8.15	8.3	8.45		
CCT:I2 off Voltage	0.35	0.5	0.65		
CCT:I2 on Voltage	0.55	0.7	0.85		
PWM_in High Level	-	-	10V		
PWM_in Low Level	-	0V	-		
PWM_in Frequency Range	200 Hz	-	2 KHz		
PWM_in Duty Cycle	0%	-	100%		
CCT:I1 off Voltage	83%	85%	87%		
CCT:I1 on Voltage	81%	83%	85%		
CCT:I2 off Voltage	3%	5%	7%		
CCT:I2 on Voltage	5%	7%	9%		

**Notes:** (1) I1 current flows between V+ and V1-;  
 (2) I2 current flows between V+ and V2-.

## Safety & EMC Compliance

Safety Category	Standard
UL/CUL	UL8750,CAN/CSA-C22.2 No. 250.13
CCC	GB 19510.1, GB 19510.14
CE	EN 61347-1, EN 61347-2-13

## Safety & EMC Compliance (Continued)

EMI Standards	Notes
EN 55015/GB 17743 <sup>(1)</sup>	Conducted emission Test & Radiated emission Test
EN 61000-3-2/GB 17625.1	Harmonic current emissions
EN 61000-3-3	Voltage fluctuations & flicker
FCC Part 15 <sup>(1)</sup>	ANSI C63.4 Class B
	This device complies with Part 15 of the FCC Rules. Operation is subject to the following two conditions: [1] this device may not cause harmful interference, and [2] this device must accept any interference received, including interference that may cause undesired Operation.
EMS Standards	Notes
EN 61000-4-2	Electrostatic Discharge (ESD): 8 kV air discharge, 4 kV contact discharge
EN 61000-4-3	Radio-Frequency Electromagnetic Field Susceptibility Test-RS
EN 61000-4-4	Electrical Fast Transient / Burst-EFT
EN 61000-4-5	Surge Immunity Test: AC Power Line: Differential Mode 4 kV, Common Mode 6 kV
EN 61000-4-6	Conducted Radio Frequency Disturbances Test-CS
EN 61000-4-8	Power Frequency Magnetic Field Test
EN 61000-4-11	Voltage Dips
EN 61547	Electromagnetic Immunity Requirements Applies To Lighting Equipment

**Note:** (1) This LED driver meets the EMI specifications above, but EMI performance of a luminaire that contains it depends also on the other devices connected to the driver and on the fixture itself.

## Derating

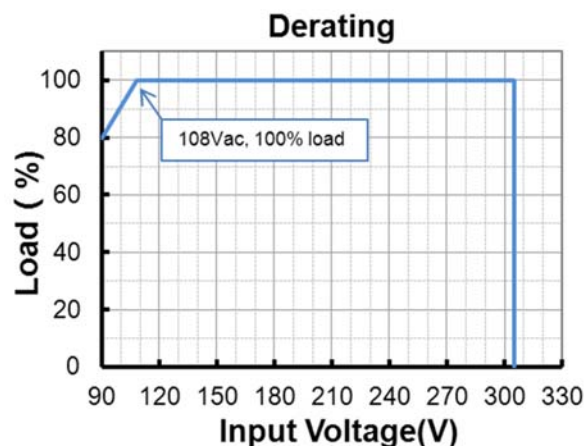

## Lifetime vs. Case Temperature

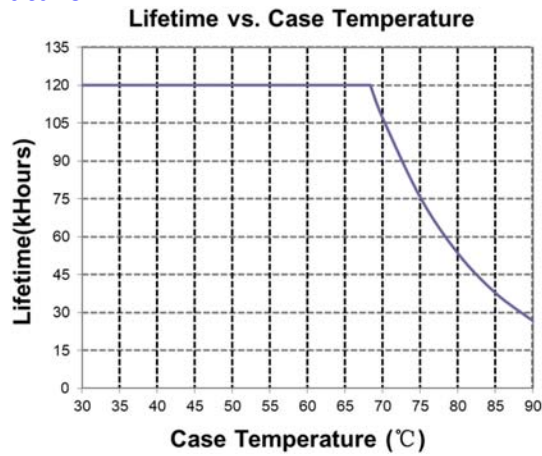

## Inrush Current Waveform

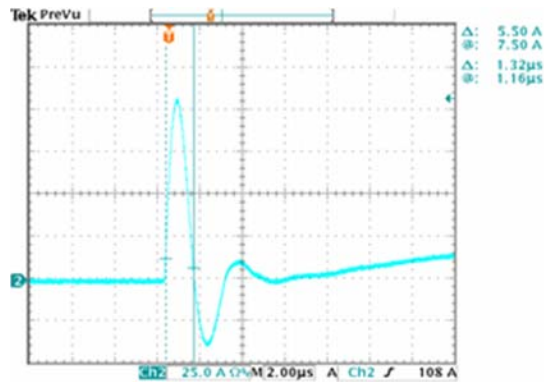

## Efficiency vs. Load

EUW-060D105DV(I<sub>o</sub>=700 mA)

### Efficiency vs. Output Voltage

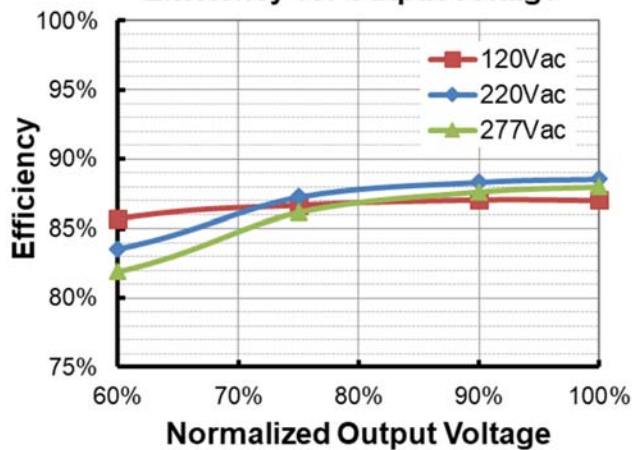

EUW-060D105DV(I<sub>o</sub>=1050 mA)

### Efficiency vs. Output Voltage

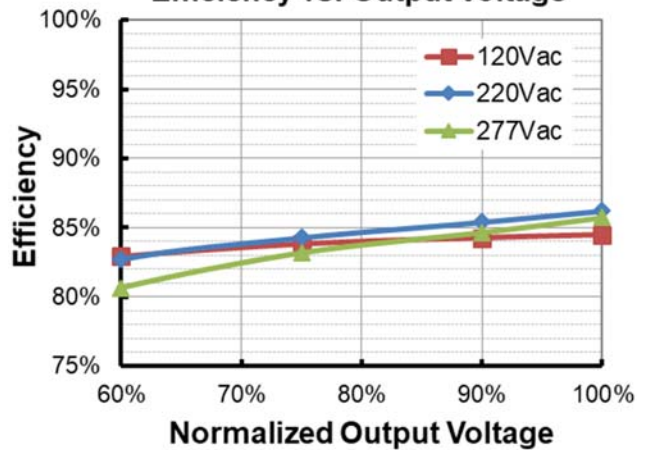



## Power Factor

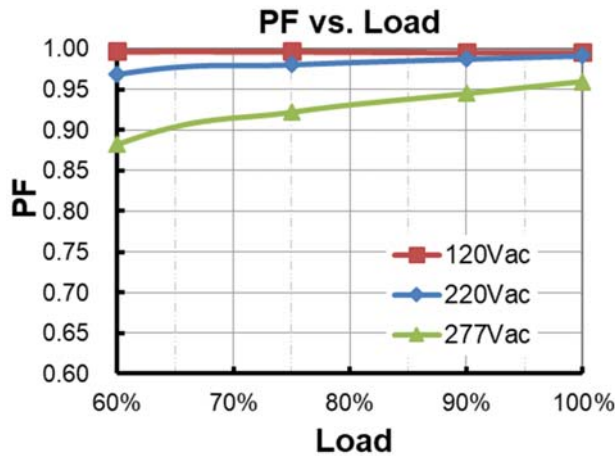

## Total Harmonic Distortion

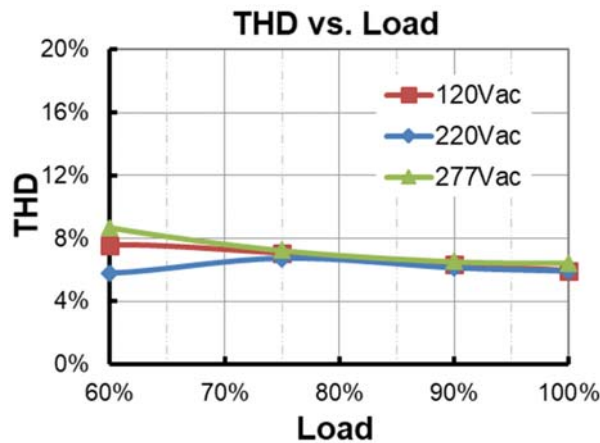

## Protection Functions

Parameter	Notes
Over Temperature Protection	Decreases output current, returning to normal after over temperature is removed.
Short Circuit Protection	Auto Recovery. No damage will occur when any output is short circuited. The output shall return to normal when the fault condition is removed.
Over Voltage Protection	Limits output voltage at no load and in case the normal voltage limit fails.

## Dimming

### ● 1-5V Dimming

The recommended implementation of the dimming control is provided below which shows **total** output current in dimming voltage related diagram and I1(black), I2(blue) distribution in CCT voltage related diagram based on full power.

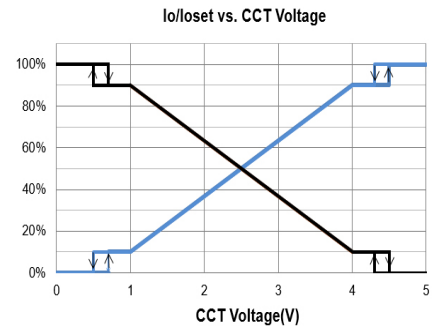
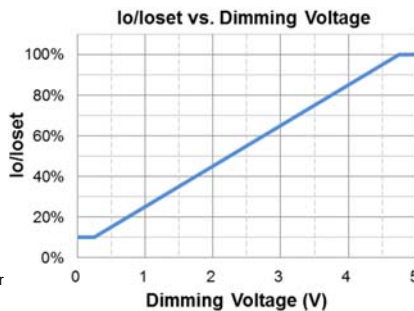
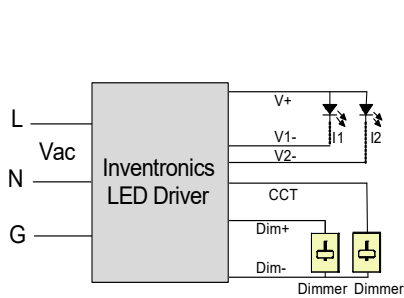

Implementation 1: Positive logic

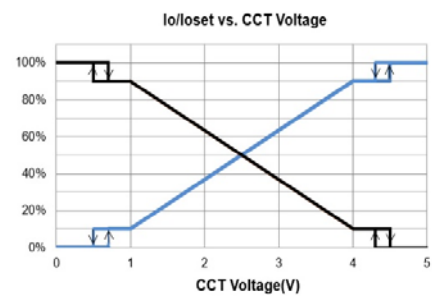
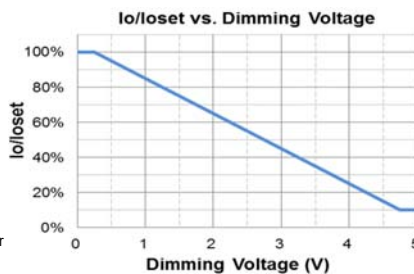
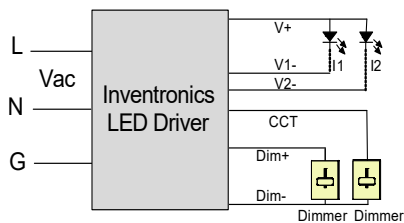

Implementation 2: Negative logic

**Notes:**

1. Do NOT connect Dim- to the output V- or V+, otherwise the driver will not work properly.
2. The dimmer can also be replaced by an active 1-5V voltage source signal or passive components like zener.
3. When 1-5V negative logic dimming mode and Dim+ is open, the driver will output maximum current.

● **1-10V Dimming**

The recommended implementation of the dimming control is provided below which shows **total** output current in dimming voltage related diagram and I1(black), I2(blue) distribution in CCT voltage related diagram based on full power.

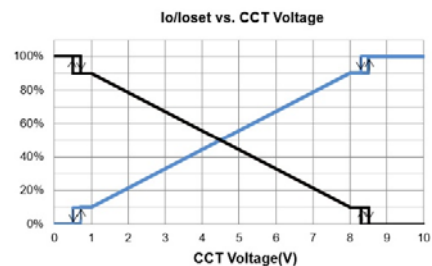
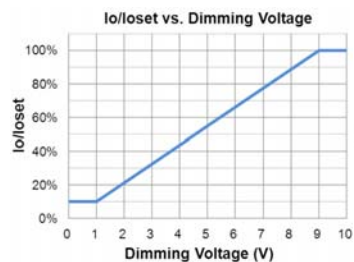
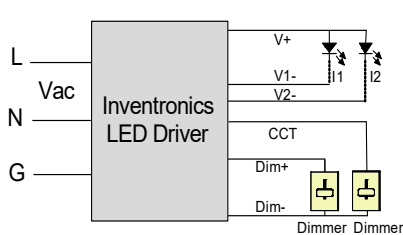

Implementation 3: Positive logic



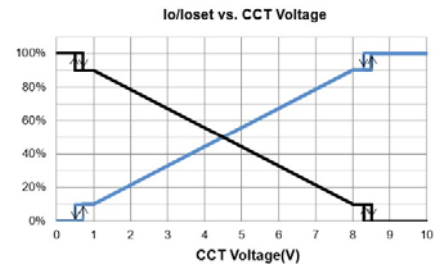
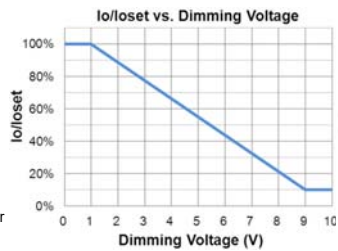
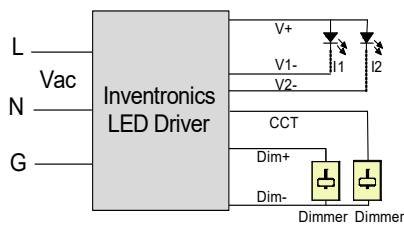

### Implementation 4: Negative logic

**Notes:**

1. Do NOT connect Dim- to the output V- or V+, otherwise the driver will not work properly.
2. The dimmer can also be replaced by an active 1-10V voltage source signal or passive components like zener.
3. When 1-10V negative logic dimming mode and Dim+ is open, the driver will output maximum current.

● **10V PWM Dimming**

The recommended implementation of the dimming control is provided below which shows **total** output current in PWM duty cycle related diagram and I1(black), I2(blue) distribution in CCT voltage related diagram based on full power.

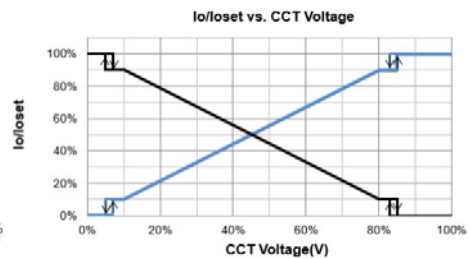
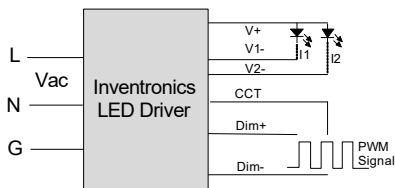

### Implementation 5: Positive logic

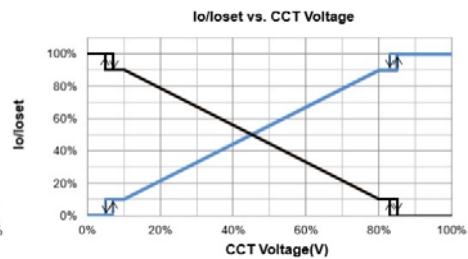
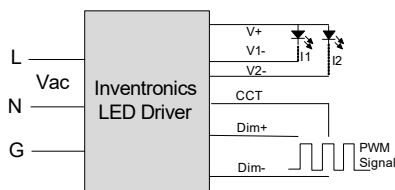

### Implementation 6: Negative logic

**Notes:**

1. Do NOT connect Dim- to the output V- or V+, otherwise the driver will not work properly.
2. When PWM negative logic dimming mode and Dim+ is open, the driver will output maximum current.

● **Time Dimming for Dim and CCT**

Time dimming control includes 3 kinds of modes, they are Self Adapting-Midnight, Self Adapting-Percentage and Traditional Timer.

- **Self Adapting-Midnight:** Automatically adjusts the dimming curve based on the on-time of past two days (if difference <15 minutes), assuming that the center point of the dimming curve is midnight local time.

- **Self Adapting-Percentage:** Automatically adjusts the on-time of each step by a constant percentage = (actual on-time for the past 2 days if difference <15 min) / (programmed on-time from the dimming curve).
- **Traditional Timer:** Follows the programmed timing curve after power on with no changes.

- **Output Lumen Compensation**

Output Lumen Compensation (OLC) may be used to maintain constant light output over the life of the LEDs by driving them at a reduced current when new, then gradually increasing the drive current over time to counteract LED lumen degradation.

## Programming Connection Diagram

*EUW-060DxxxDV*

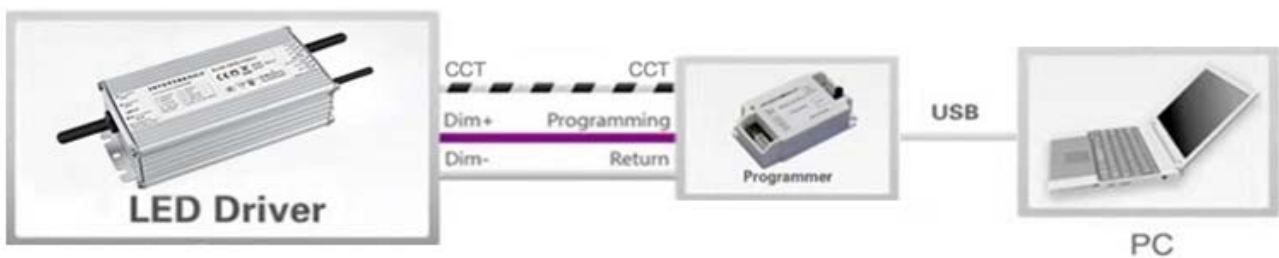

*EUW-060DxxxDF*

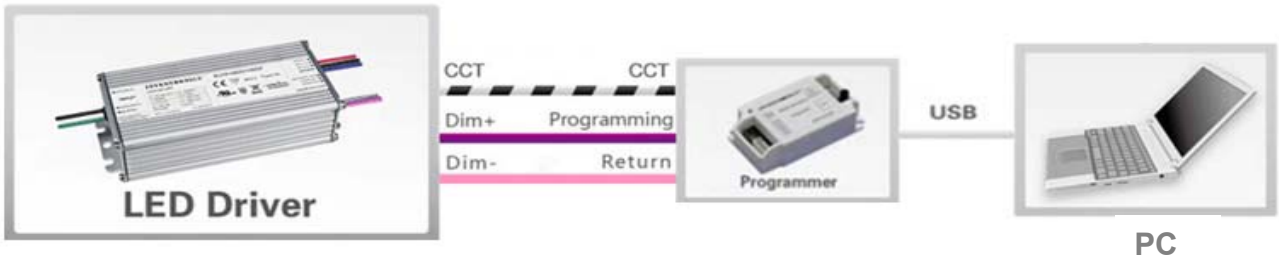

**Note:** The driver does not need to be powered on during the programming process.

- Please refer to [PRG-MUL2](#) (Programmer) datasheet for details.

## Mechanical Outline

### EUW-060D105DV

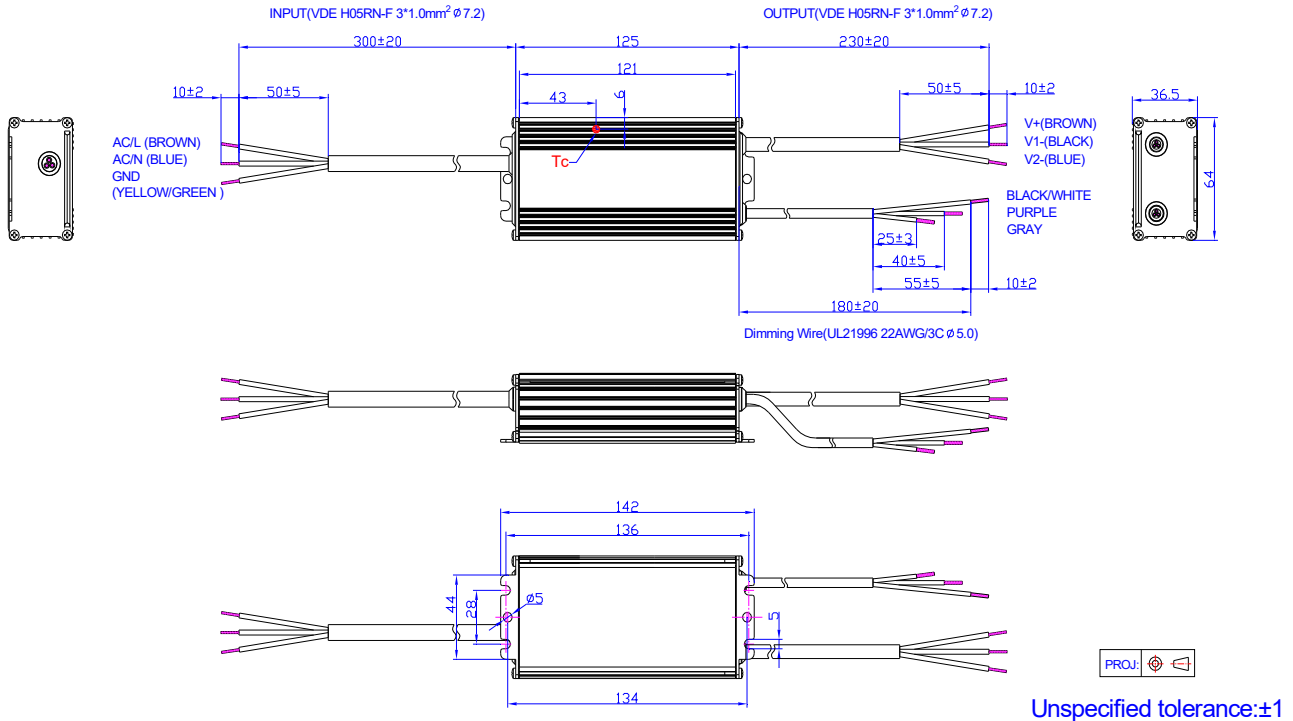

### EUW-060D105DF

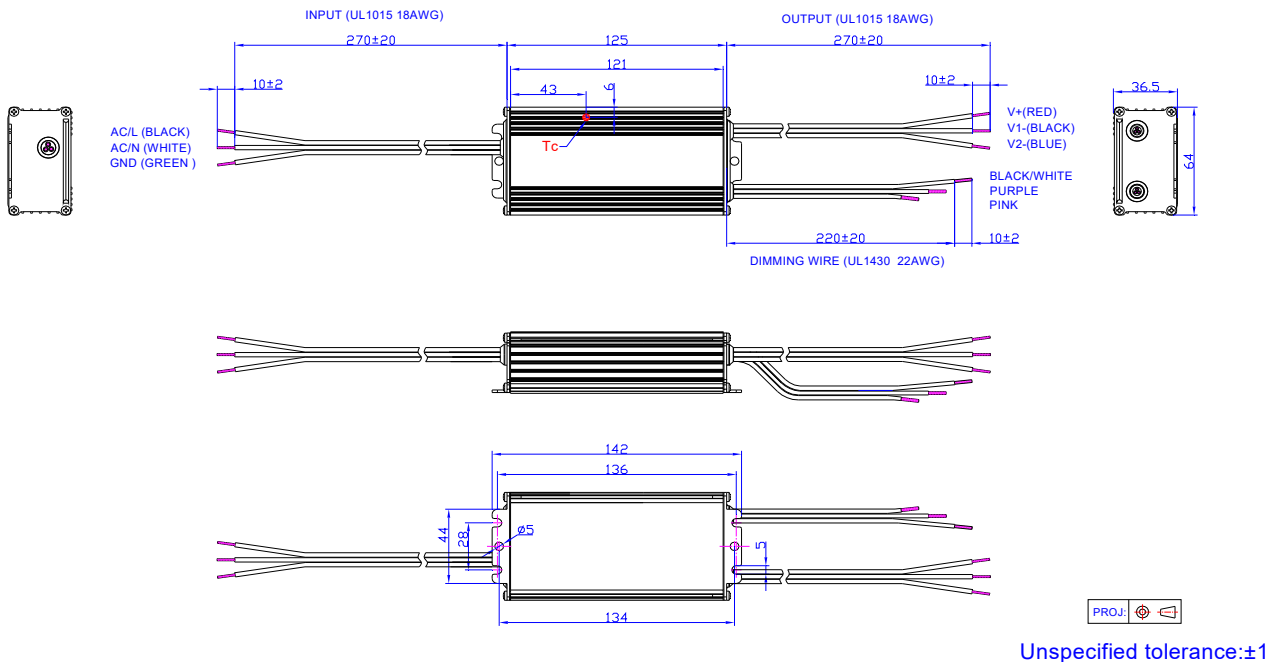

## RoHS Compliance

Our products comply with reference to RoHS Directive (EU) 2015/863 amending 2011/65/EU, calling for the elimination of lead and other hazardous substances from electronic products..

## Revision History

Change Date	Rev.	Description of Change		
		Item	From	To
2021-07-19	A	Datasheet Release	/	/
2021-08-06	B	Features	/	Updated
		Mechanical Outline	/	Updated