

Features

- Full Power at Wide Output Current Range (Constant Power)
- Adjustable Output Current (AOC) with Programmability
- Isolated 1-5V/1-10V/10V PWM/3-Timer-Modes Dimmable
- Output Lumen Compensation
- Input Surge Protection: DM 6kV, CM 10kV
- All-Around Protection: OVP, SCP, OTP
- IP66/IP67
- SELV Output
- Suitable for Luminaires with Protection Class I and II
- 5 Years Warranty



Description

The EUM-150SxxxDE series is a 150W, constant-current, programmable and IP66/IP67 rated LED driver that operates from 90-305Vac input with excellent power factor. It is created for many lighting applications including high bay, high mast and roadway etc. The high efficiency of these drivers and compact metal case enables them to run cooler, significantly improving reliability and extending product life. To ensure trouble-free operation, protection is provided against input surge, output over voltage, short circuit, and over temperature.

Models

Adjustable Output Current Range	Full-Power Current Range(1)	Default Output Current	Input Voltage Range(2)	Output Voltage Range	Max. Output Power	Typical Efficiency (3)	Typical Power Factor		Model Number (4)
							120Vac	220Vac	
53-700mA	530-700mA	530mA	90~305 Vac/ 127~300 Vdc	107~284 Vdc	150W	93.5%	0.99	0.96	EUM-150S070DE
70-1050mA	700-1050mA	700mA	90~305 Vac/ 127~300 Vdc	72~214 Vdc	150W	93.0%	0.99	0.96	EUM-150S105DE
105-1500mA	1050-1500mA	1050mA	90~305 Vac/ 127~300 Vdc	50~143 Vdc	150W	93.5%	0.99	0.96	EUM-150S150DE
140-2100mA	1400-2100mA	1400mA	90~305 Vac/ 127~300 Vdc	36~107 Vdc	150W	92.0%	0.99	0.96	EUM-150S210DE ⁽⁵⁾
280-4200mA	2800-4200mA	3150mA	90~305 Vac/ 127~300 Vdc	18 ~ 54 Vdc	150W	91.5%	0.99	0.96	EUM-150S420DE ⁽⁵⁾

- Notes:** (1) Output current range with constant power at 150W
 (2) Certified input voltage range: 100-240Vac.
 (3) Measured at 100% load and 220Vac input (see below "General Specifications" for details).
 (4) All the models are certificated to KS, except EUM-150S070DE.
 (5) SELV output.

I-V Operation Area

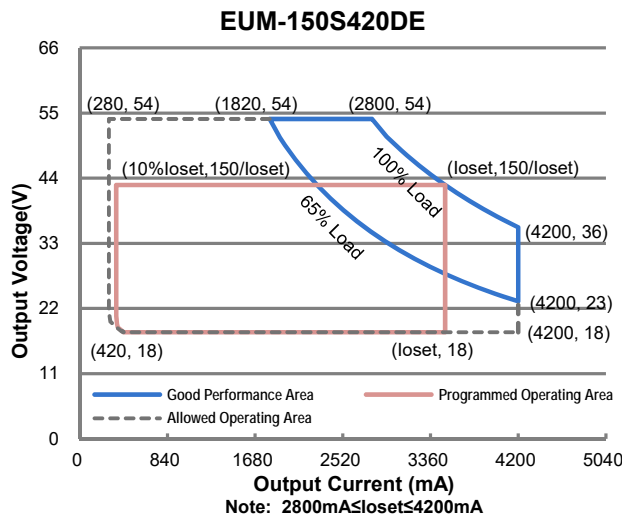
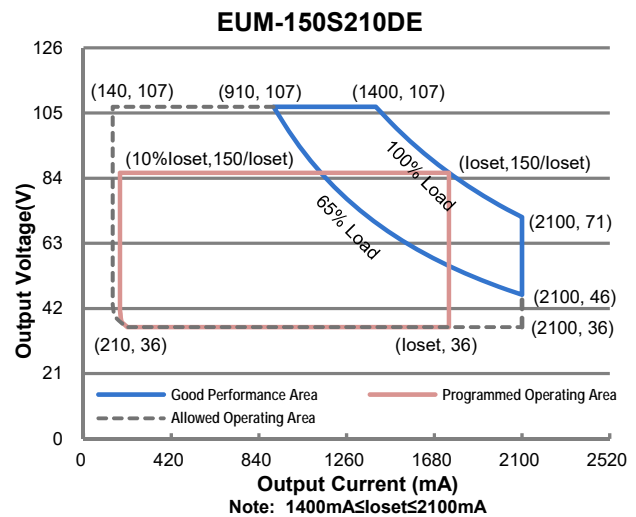
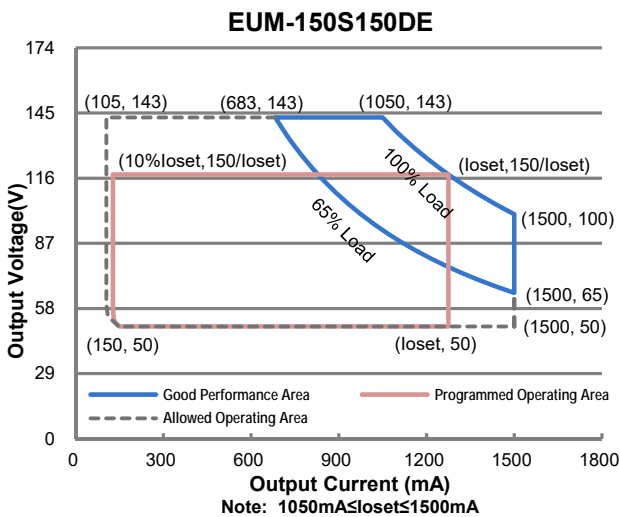
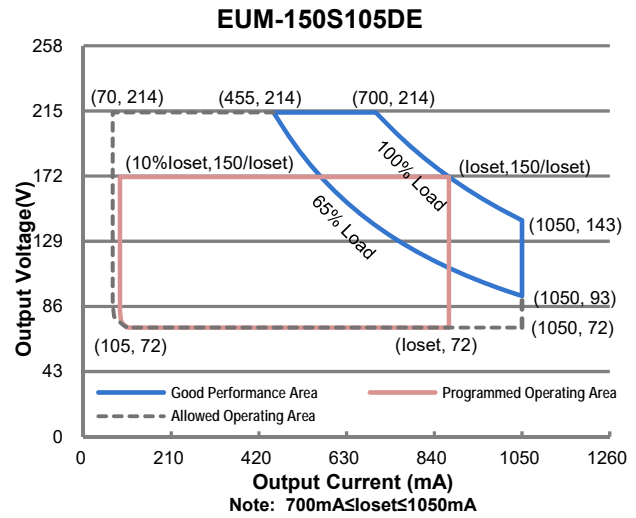
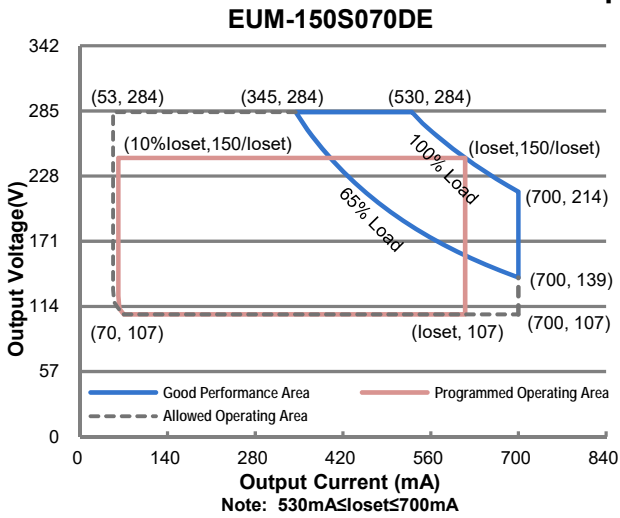

Input Specifications

Parameter	Min.	Typ.	Max.	Notes
Input AC Voltage	90 Vac	-	305 Vac	
Input DC Voltage	127 Vdc	-	300 Vdc	
Input Frequency	47 Hz	-	63 Hz	
Leakage Current	-	-	0.70 mA	IEC 60598-1; 240Vac/60Hz
Input AC Current	-	-	1.50 A	Measured at 100% load and 120 Vac input.
	-	-	0.80 A	Measured at 100% load and 220 Vac input.
Inrush Current(I ² t)	-	-	3.55 A ² s	At 220Vac input, 25°C cold start, duration=220 μs, 10%Ipk-10%Ipk. See Inrush Current Waveform for the details.
PF	0.9	-	-	At 100-277Vac, 50-60Hz, 65%-100% Load (97.5-150W)
THD	-	-	20%	
THD	-	-	10%	At 220-240Vac, 50-60Hz, 75%-100% Load (112.5-150W)

Output Specifications

Parameter	Min.	Typ.	Max.	Notes
Output Current Tolerance	-5%loset	-	5%loset	At 100% load condition
Output Current Setting(loset) Range				
EUM-150S070DE	53 mA	-	700 mA	
EUM-150S105DE	70 mA	-	1050 mA	
EUM-150S150DE	105 mA	-	1500 mA	
EUM-150S210DE	140 mA	-	2100 mA	
EUM-150S420DE	280 mA	-	4200 mA	
Output Current Setting Range with Constant Power				
EUM-150S070DE	530 mA	-	700 mA	
EUM-150S105DE	700 mA	-	1050 mA	
EUM-150S150DE	1050 mA	-	1500 mA	
EUM-150S210DE	1400 mA	-	2100 mA	
EUM-150S420DE	2800 mA	-	4200 mA	
Total Output Current Ripple (pk-pk)	-	5%lomax	10%lomax	At 100% load condition. 20 MHz BW
Output Current Ripple at < 200 Hz (pk-pk)	-	2%lomax	-	At 100% load condition. Only this component of ripple is associated with visible flicker.
Startup Overshoot Current	-	-	10%lomax	At 100% load condition
No Load Output Voltage				
EUM-150S070DE	-	-	320 V	
EUM-150S105DE	-	-	240 V	
EUM-150S150DE	-	-	160 V	
EUM-150S210DE	-	-	120 V	
EUM-150S420DE	-	-	60 V	
Line Regulation	-	-	±0.5%	Measured at 100% load

Output Specifications (Continued)

Parameter	Min.	Typ.	Max.	Notes
Load Regulation	-	-	±1.5%	
Turn-on Delay Time	-	-	0.5 s	Measured at 120-277Vac input, 65%-100% Load
Temperature Coefficient of loset	-	0.03%/°C	-	Case temperature = 0°C ~Tc max

General Specifications

Parameter	Min.	Typ.	Max.	Notes
Efficiency at 120 Vac input: EUM-150S070DE				Measured at 100% load and steady-state temperature in 25°C ambient; (Efficiency will be about 2.0% lower if measured immediately after startup.)
Io= 530 mA	89.0%	91.0%	-	
Io= 070 mA	90.0%	92.0%	-	
EUM-150S105DE				
Io= 700 mA	88.5%	90.5%	-	
Io=1050 mA	89.0%	91.0%	-	
EUM-150S150DE				
Io=1050 mA	89.0%	91.0%	-	
Io=1500 mA	89.5%	91.5%	-	
EUM-150S210DE				
Io=1400 mA	87.5%	89.5%	-	
Io=2100 mA	88.0%	90.0%	-	
EUM-150S420DE				
Io=2800 mA	87.0%	89.0%	-	
Io=4200 mA	86.5%	88.5%	-	
Efficiency at 220 Vac input: EUM-150S070DE				Measured at 100% load and steady-state temperature in 25°C ambient; (Efficiency will be about 2.0% lower if measured immediately after startup.)
Io= 530 mA	91.0%	93.0%	-	
Io= 070 mA	91.5%	93.5%	-	
EUM-150S105DE				
Io= 700 mA	90.5%	92.5%	-	
Io=1050 mA	91.0%	93.0%	-	
EUM-150S150DE				
Io=1050 mA	91.0%	93.0%	-	
Io=1500 mA	91.5%	93.5%	-	
EUM-150S210DE				
Io=1400 mA	89.5%	91.5%	-	
Io=2100 mA	90.0%	92.0%	-	
EUM-150S420DE				
Io=2800 mA	89.5%	91.5%	-	
Io=4200 mA	89.0%	91.0%	-	
Efficiency at 277 Vac input: EUM-150S070DE				Measured at 100% load and steady-state temperature in 25°C ambient; (Efficiency will be about 2.0% lower if measured immediately after startup.)
Io= 530 mA	91.5%	93.5%	-	
Io= 070 mA	92.0%	94.0%	-	
EUM-150S105DE				
Io= 700 mA	91.0%	93.0%	-	
Io=1050 mA	91.5%	93.5%	-	
EUM-150S150DE				
Io=1050 mA	91.5%	93.5%	-	
Io=1500 mA	91.5%	93.5%	-	
EUM-150S210DE				
Io=1400 mA	90.0%	92.0%	-	
Io=2100 mA	90.0%	92.0%	-	
EUM-150S420DE				
Io=2800 mA	89.5%	91.5%	-	
Io=4200 mA	89.0%	91.0%	-	

General Specifications (Continued)

Parameter	Min.	Typ.	Max.	Notes
MTBF	-	333,000 Hours	-	Measured at 220Vac input, 80%Load and 25°C ambient temperature (MIL-HDBK-2 17F)
Lifetime	-	106,000 Hours	-	Measured at 220Vac input, 80%Load and 70°C case temperature; See lifetime vs. Tc curve for the details
Operating Case Temperature for Safety Tc_s	-40°C	-	+90°C	
Operating Case Temperature for Warranty Tc_w	-40°C	-	+80°C	Case temperature for 5 years warranty Humidity: 10% RH to 95% RH
Storage Temperature	-40°C	-	+85°C	Humidity: 5% RH to 95% RH
Dimensions Inches (L × W × H) Millimeters (L × W × H)	6.54 × 2.36 × 1.44 166 × 60 × 36.5			With mounting ear 7.20 × 2.36 × 1.44 183 × 60 × 36.5
Net Weight	-	735 g	-	

Dimming Specifications

Parameter	Min.	Typ.	Max.	Notes	
Absolute Maximum Voltage on the Vdim (+) Pin	-20 V	-	20 V		
Source Current on Vdim (+)Pin	200 µA	300 µA	450 µA	Vdim(+) = 0 V	
Dimming Output Range	EUM-150S070DE EUM-150S105DE EUM-150S150DE EUM-150S210DE EUM-150S420DE	10%loset	-	loset	530 mA ≤ loset ≤ 700 mA 700 mA ≤ loset ≤ 1050 mA 1050 mA ≤ loset ≤ 1500 mA 1400 mA ≤ loset ≤ 2100 mA 2800 mA ≤ loset ≤ 4200 mA
	EUM-150S070DE EUM-150S105DE EUM-150S150DE EUM-150S210DE EUM-150S420DE	53 mA 70 mA 105 mA 140 mA 280 mA	-	loset	53 mA ≤ loset < 530 mA 70 mA ≤ loset < 700 mA 105 mA ≤ loset < 1050 mA 140 mA ≤ loset < 1400 mA 280 mA ≤ loset < 2800 mA
Recommended Dimming Range for 1-5V	0.25 V	-	4.75 V	Dimming mode set to 1-5V in PC interface.	
Recommended Dimming Range for 1-10V	1 V	-	9 V	Default 1-10V dimming mode with positive logic.	
PWM_in High Level	-	10V	-		
PWM_in Low Level	-	0V	-		
PWM_in Frequency Range	200 Hz	-	2 KHz		
PWM_in Duty Cycle	0%	-	100%		

Safety & EMC Compliance

Safety Category	Standard
ENEC & CE	EN 61347-1 ⁽¹⁾ , EN 61347-2-13
UKCA	BS EN 61347-1 ⁽¹⁾ , BS EN 61347-2-13
CB	IEC 61347-1 ⁽¹⁾ , IEC 61347-2-13
KS	KS C 7655
Performance	Standard
ENEC	EN 62384
EMI Standards	Notes
BS EN/EN IEC 55015 ⁽²⁾	Conducted emission Test & Radiated emission Test
BS EN/EN IEC 61000-3-2	Harmonic current emissions
BS EN/EN 61000-3-3	Voltage fluctuations & flicker
EMS Standards	Notes
BS EN/EN 61000-4-2	Electrostatic Discharge (ESD): 8 kV air discharge, 4 kV contact discharge
BS EN/EN 61000-4-3	Radio-Frequency Electromagnetic Field Susceptibility Test-RS
BS EN/EN 61000-4-4	Electrical Fast Transient / Burst-EFT
BS EN/EN 61000-4-5	Surge Immunity Test: AC Power Line: Differential Mode 6 kV, Common Mode 10 kV
BS EN/EN 61000-4-6	Conducted Radio Frequency Disturbances Test-CS
BS EN/EN 61000-4-8	Power Frequency Magnetic Field Test
BS EN/EN 61000-4-11	Voltage Dips
BS EN/EN 61547	Electromagnetic Immunity Requirements Applies To Lighting Equipment

Note: (1) This product meets the requirements for IEC/BS EN/EN 61347-1(Class II), when the driver is energized, the allowed leakage current is perceptible but harmless.

(2) This LED driver meets the EMI specifications above, but EMI performance of a luminaire that contains it depends also on the other devices connected to the driver and on the fixture itself.

Derating

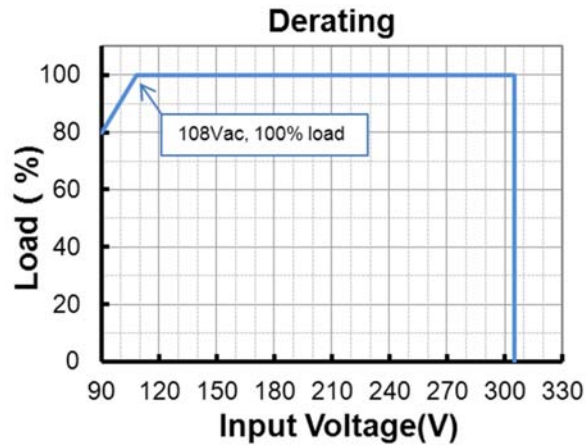

Lifetime vs. Case Temperature

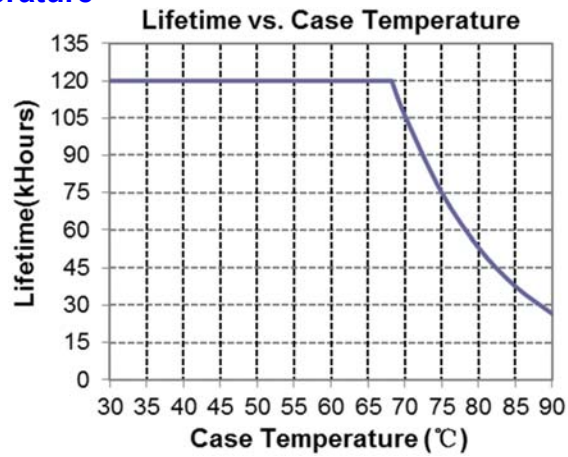

Inrush Current Waveform

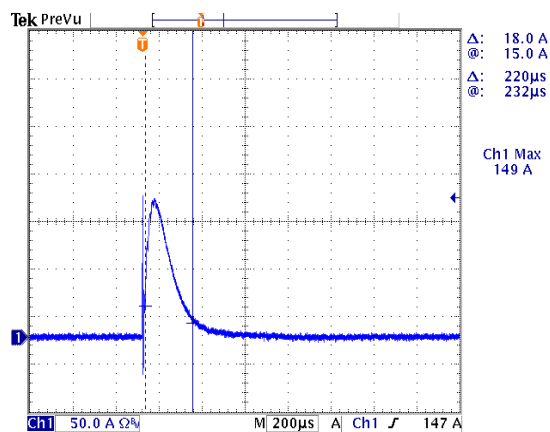

Efficiency vs. Load

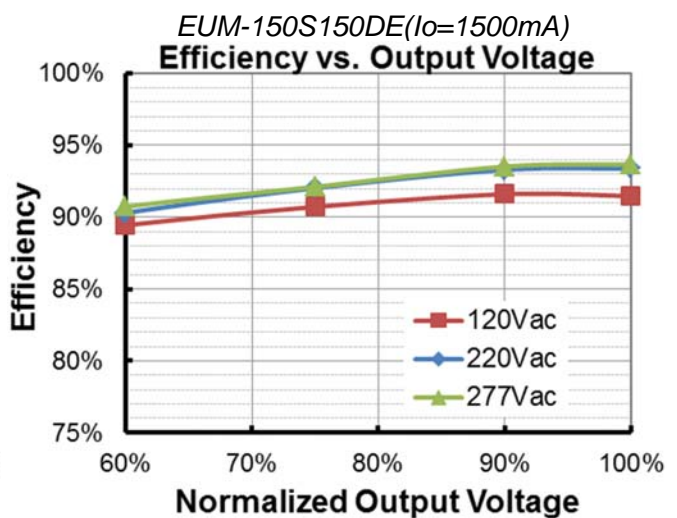
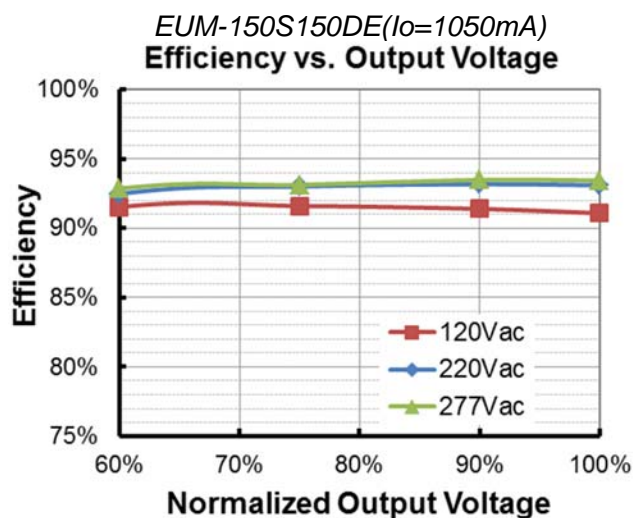
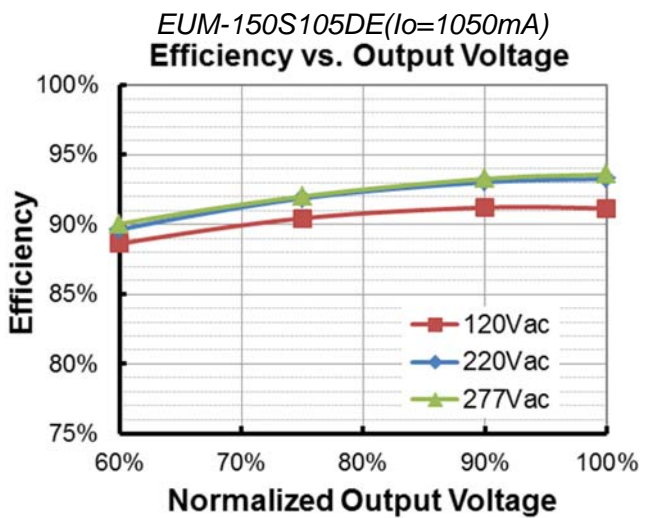
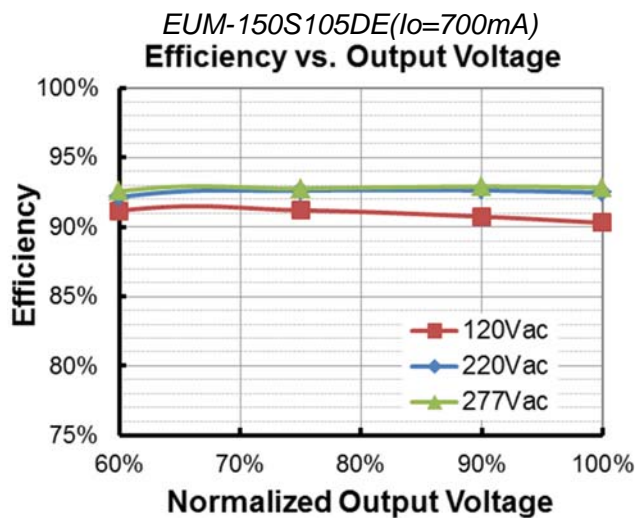
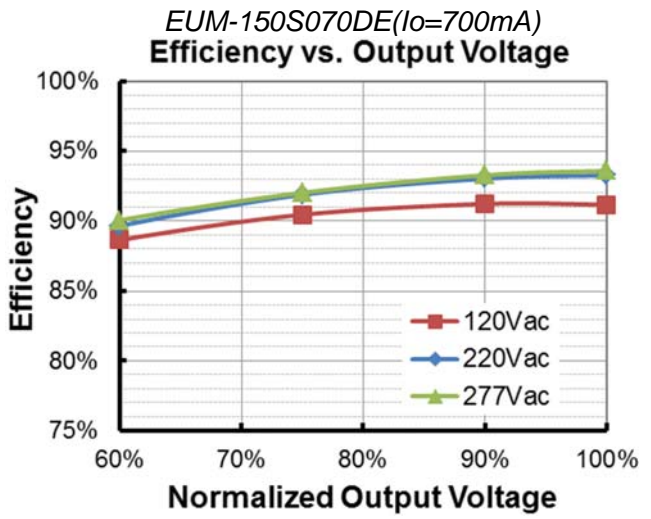
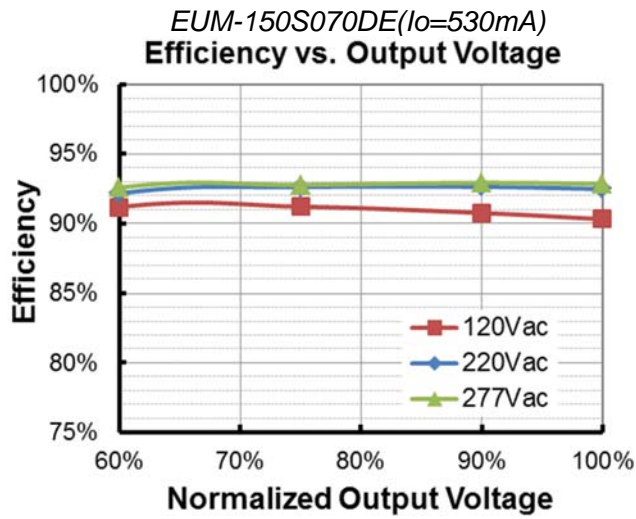

EUM-150S210DE (Io=1400mA)
Efficiency vs. Output Voltage

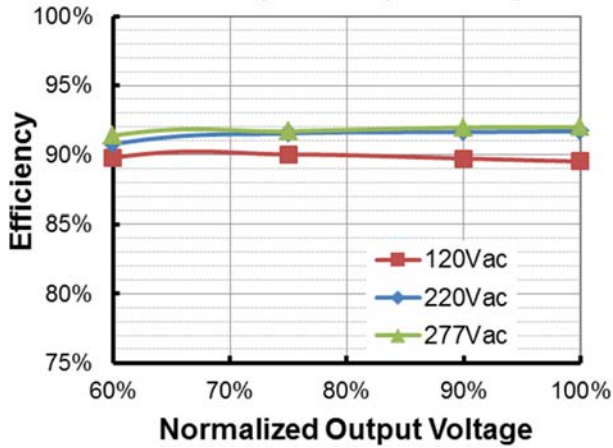

EUM-150S210DE (Io=2100mA)
Efficiency vs. Output Voltage

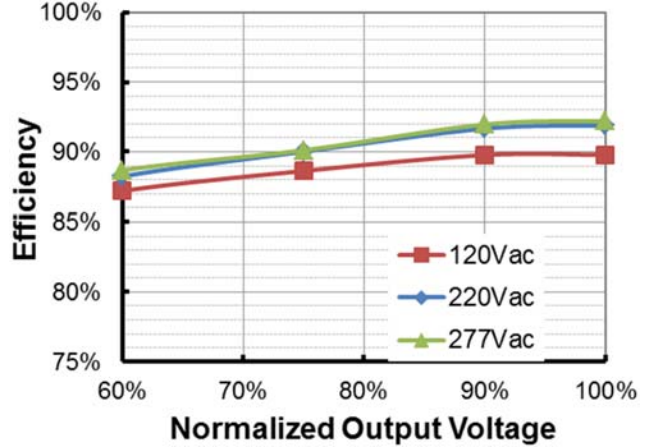

EUM-150S420DE (Io=2800mA)
Efficiency vs. Output Voltage

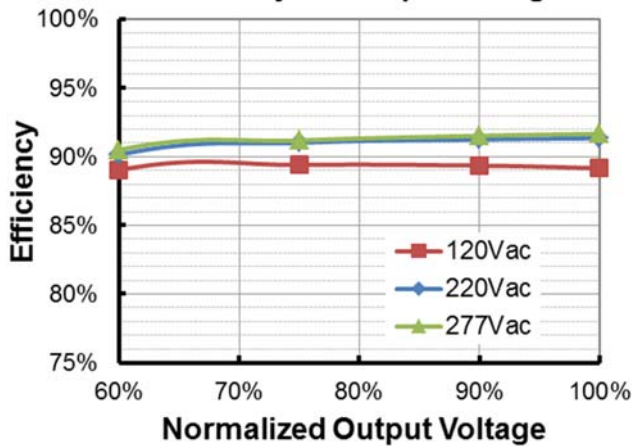

EUM-150S420DE (Io=4200mA)
Efficiency vs. Output Voltage

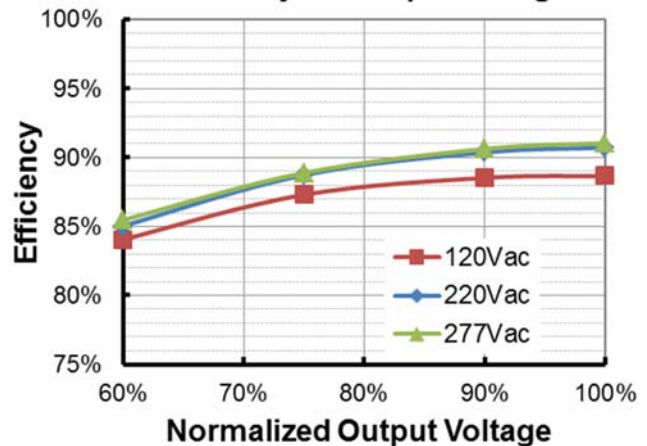

Power Factor

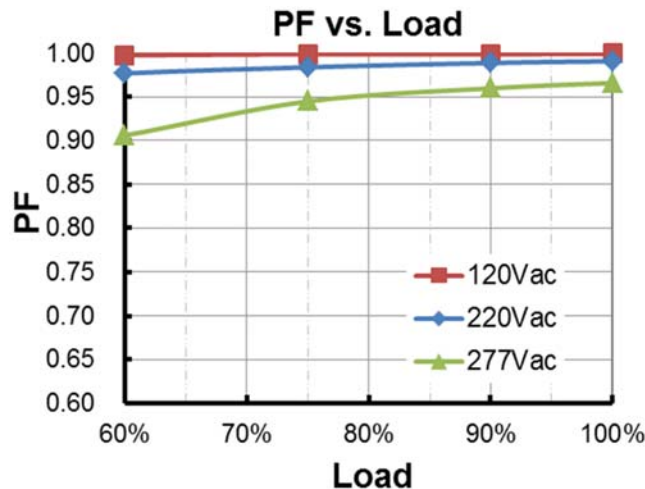

Total Harmonic Distortion

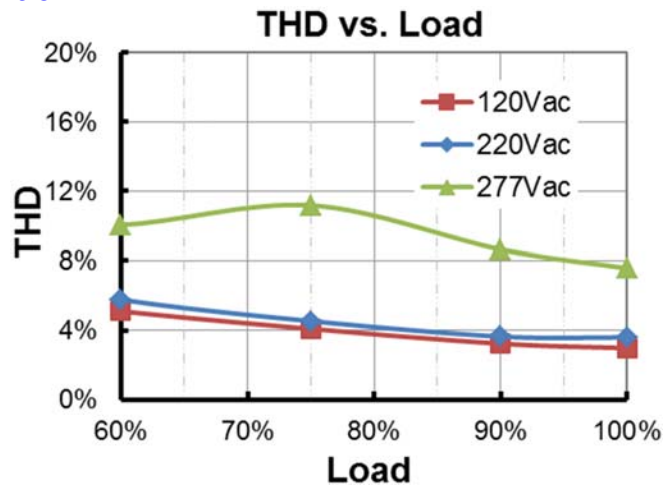

Protection Functions

Parameter	Notes
Over Temperature Protection	Decreases output current, returning to normal after over temperature is removed.
Short Circuit Protection	Auto Recovery. No damage will occur when any output is short circuited. The output shall return to normal when the fault condition is removed.
Over Voltage Protection	Limits output voltage at no load and in case the normal voltage limit fails.

Dimming

● 1-5V Dimming

The recommended implementation of the dimming control is provided below.

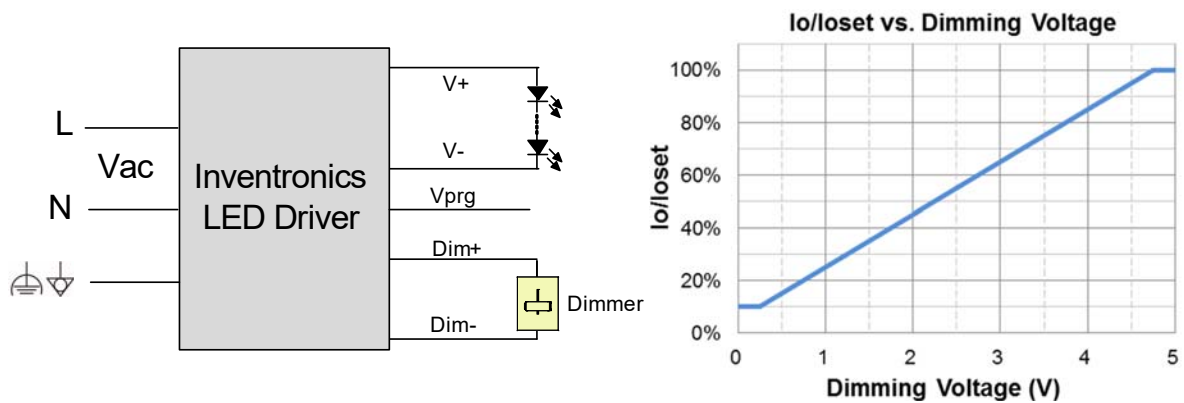

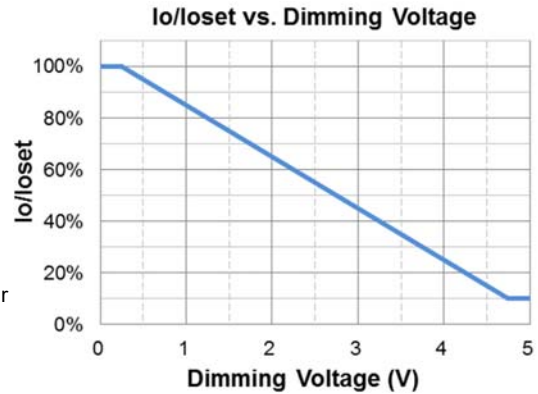
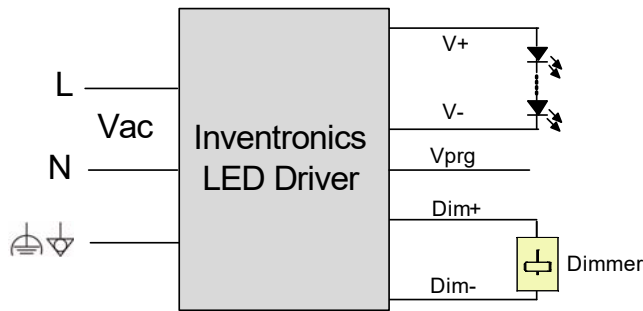

Implementation 2: Negative logic

Notes:

1. Do NOT connect Dim- to the output V- or V+, otherwise the driver will not work properly.
2. The dimmer can also be replaced by an active 1-5V voltage source signal or passive components like zener.
3. When 1-5V negative logic dimming mode and Dim+ is open, the driver will output maximum current.

● **1-10V Dimming**

The recommended implementation of the dimming control is provided below.

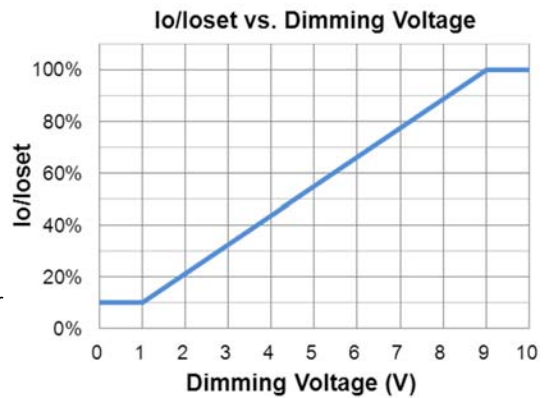
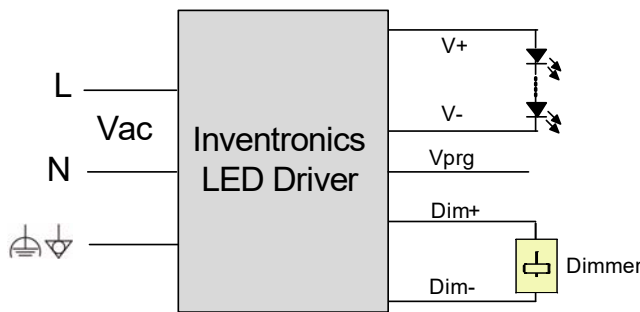

Implementation 3: Positive logic

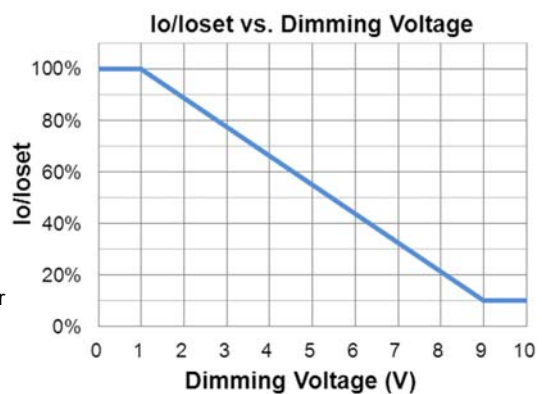
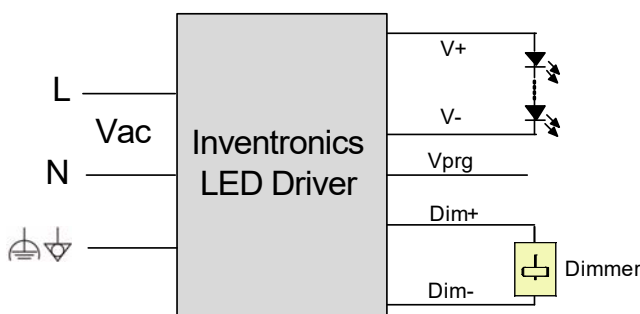

Implementation 4: Negative logic

Notes:

1. Do NOT connect Dim- to the output V- or V+, otherwise the driver will not work properly
2. The dimmer can also be replaced by an active 1-10V voltage source signal or passive components like zener.
3. When 1-10V negative logic dimming mode and Dim+ is open, the driver will output minimum current.

● **10V PWM Dimming**

The recommended implementation of the dimming control is provided below.

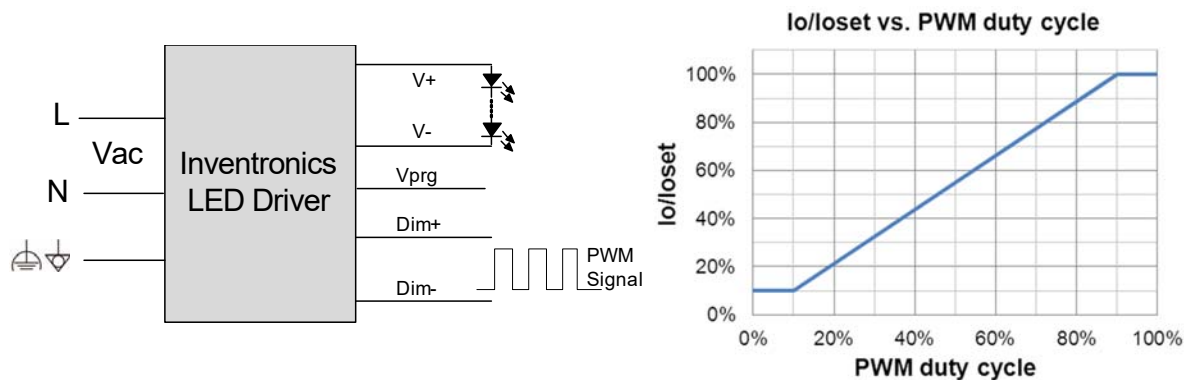

Implementation 5: Positive logic

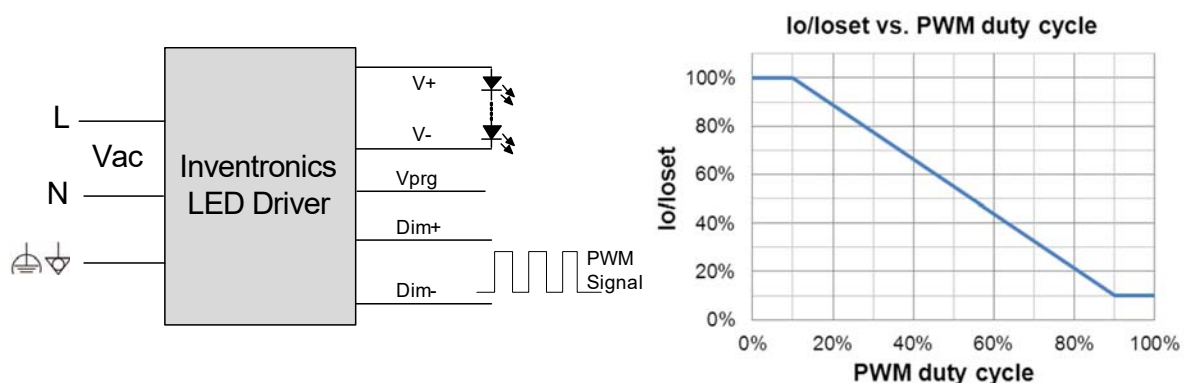

Implementation 6: Negative logic

Notes:

1. Do NOT connect Dim- to the output V- or V+, otherwise the driver will not work properly
2. When 10V PWM negative logic dimming mode and Dim+ is open, the driver will output minimum current.

● **Time Dimming**

Time dimming control includes 3 kinds of modes, they are Self Adapting-Midnight, Self Adapting-Percentage and Traditional Timer.

- **Self Adapting-Midnight:** Automatically adjusts the dimming curve based on the on-time of past two days (if difference <15 minutes), assuming that the center point of the dimming curve is midnight local time.
- **Self Adapting-Percentage:** Automatically adjusts the on-time of each step by a constant percentage = (actual on-time for the past 2 days if difference <15 min) / (programmed on-time from the dimming curve).
- **Traditional Timer:** Follows the programmed timing curve after power on with no changes.

● **Output Lumen Compensation**

Output Lumen Compensation (OLC) may be used to maintain constant light output over the life of the LEDs by driving them at a reduced current when new, then gradually increasing the drive current over time to counteract LED lumen degradation.

Programming Connection Diagram

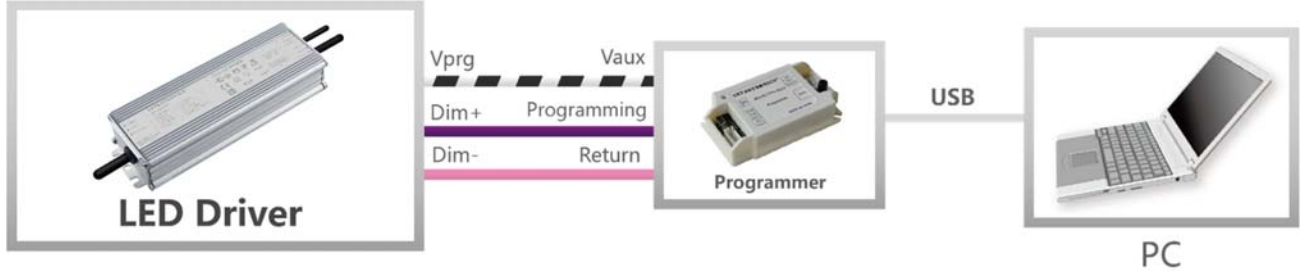

Note: The driver does not need to be powered on during the programming process.

● Please refer to [PRG-MUL2](#) (Programmer) datasheet for details.

Mechanical Outline

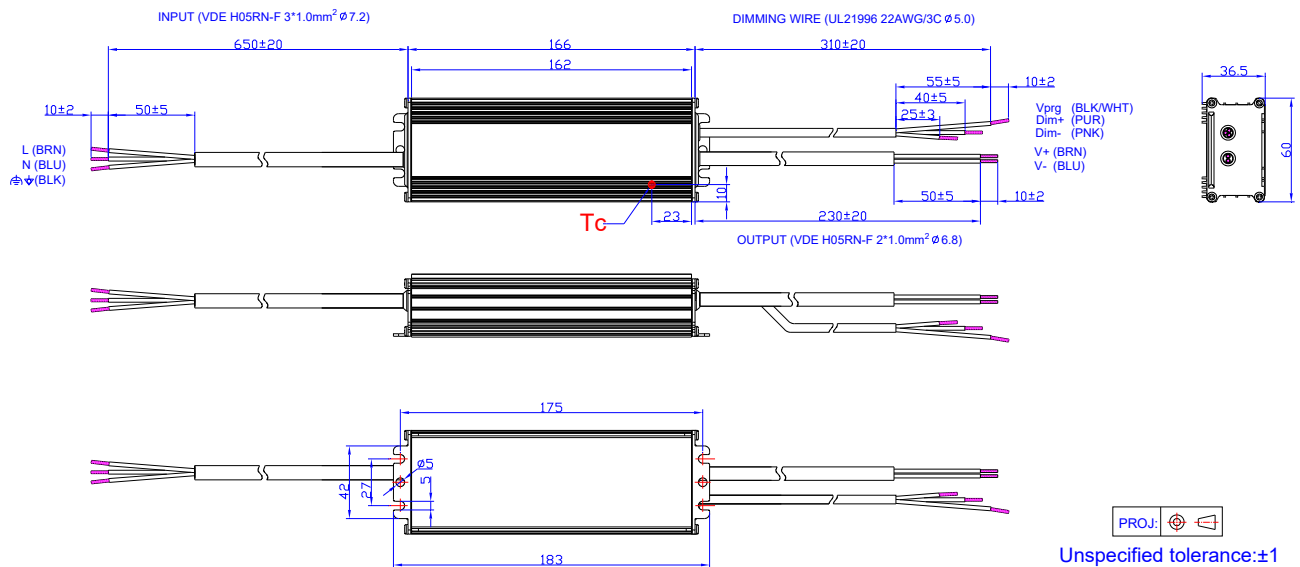

RoHS Compliance

Our products comply with reference to RoHS Directive (EU) 2015/863 amending 2011/65/EU, calling for the elimination of lead and other hazardous substances from electronic products.

Revision History

Change Date	Rev.	Description of Change		
		Item	From	To
2022-03-08	A	Datasheet Release	/	/
2023-06-09	B	Product Photograph	/	Updated
		Safety & EMC Compliance	/	Updated
		Dimming	/	Updated
		Programming Connection Diagram	/	Updated
		Mechanical Outline	/	Updated