

Features

- Ultra High Efficiency (Up to 94.5%)
- Full Power at Wide Output Current Range (Constant Power)
- Adjustable Output Current (AOC) with Programmability
- Isolated 0-10V/10V PWM/Resistor Dimmable
- Dim-to-Low-Voltage(DTLV)
- Maximum Dimming Level with 9V or 10V Selectable
- Fade-Time Adjustable
- Output Lumen Compensation
- End-of-Life Indicator
- Input Surge Protection: DM 6kV, CM 6kV
- All-Around Protection: OVP, SCP, OTP
- IP65 and UL Dry/Damp Location
- TYPE HL, for use in a Class I, Division 2 Hazardous (Classified) Location
- 5 Years Warranty



Description

The SSM-220SxxxHF series is a 220W, constant-current, programmable and IP65 rated LED driver that operates from 249-528Vac input with excellent power factor. Created for many lighting applications including horticulture, high bay, etc. The high efficiency of this driver enables it to run cooler, significantly improving reliability and extending product life. To ensure trouble-free operation, protection is provided against input surge, output over voltage, short circuit, and over temperature.

Models

Adjustable Output Current Range	Full-Power Current Range(1)	Default Output Current	Input Voltage Range(2)	Output Voltage Range	Max. Output Power	Typical Efficiency (3)	Typical Power Factor		Model Number (4)
							277Vac	480Vac	
410-5300mA	4100-5300mA	4100mA	249~528Vac/ 352~500 Vdc	34-54 Vdc	220 W	94.5%	0.99	0.96	SSM-220S530HF

- Notes:** (1) Output current range with constant power at 220W
 (2) Certified input voltage range: 277-480Vac;
 (3) Measured at 100% load and 480Vac input (see below "General Specifications" for details).
 (4) SELV output.

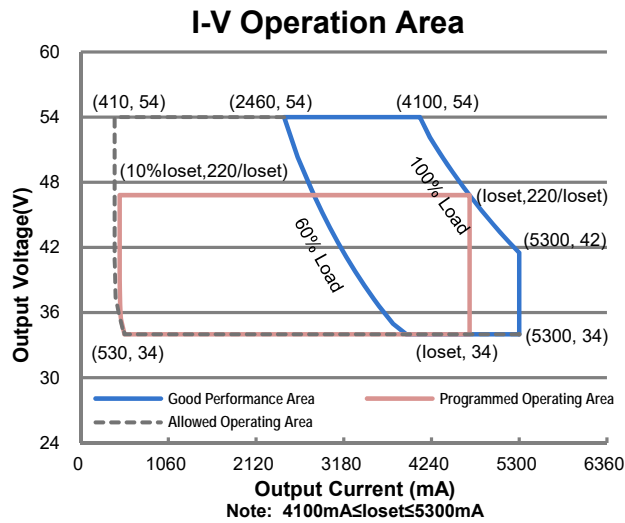

Input Specifications

Parameter	Min.	Typ.	Max.	Notes
Input AC Voltage	249 Vac	-	528 Vac	
Input DC Voltage	352 Vdc	-	500 Vdc	
Input Frequency	47 Hz	-	63 Hz	
Leakage Current	-	-	0.75 MIU	UL 8750; 480Vac/ 60Hz
	-	-	0.70 mA	IEC 60598-1; 480Vac/ 60Hz
Input AC Current	-	-	0.97 A	Measured at 100% load and 277 Vac input.
	-	-	0.56 A	Measured at 100% load and 480 Vac input.
Inrush Current(I ² t)	-	-	4.42 A ² s	At 480Vac input, 25°C cold start, duration=230 μs, 10%I _{pk} -10%I _{pk} . See Inrush Current Waveform for the details.
PF	0.9	-	-	At 277-480Vac, 50-60Hz, 60%-100% load (132-220W)
THD	-	-	20%	

Output Specifications

Parameter	Min.	Typ.	Max.	Notes
Output Current Tolerance	-5%loset	-	5%loset	At 100% load condition
Output Current Setting(I _o set) Range				
SSM-220S530HF	410 mA	-	5300 mA	
Output Current Setting Range with Constant Power				
SSM-220S530HF	4100 mA	-	5300 mA	
Total Output Current Ripple (pk-pk)	-	5%I _o max	10%I _o max	At 100% load condition. 20 MHz BW

Output Specifications (Continued)

Parameter	Min.	Typ.	Max.	Notes
Output Current Ripple at < 200 Hz (pk-pk)	-	2%I _o max	-	At 100% load condition. Only this component of ripple is associated with visible flicker.
Startup Overshoot Current	-	-	10%I _o max	At 100% load condition
No Load Output Voltage SSM-220S530HF	-	-	60V	
Line Regulation	-	-	±0.5%	Measured at 100% load
Load Regulation	-	-	±3.0%	
Turn-on Delay Time	-	-	0.5 s	Measured at 277-480Vac input, 60%-100%load
Temperature Coefficient of I _o set	-	0.03%/°C	-	Case temperature = 0°C ~T _c max

General Specifications

Parameter	Min.	Typ.	Max.	Notes
Efficiency at 277 Vac input: SSM-220S530HF I _o =4100 mA I _o =5300 mA	91.0% 91.5%	93.0% 93.5%	- -	Measured at 100% load and steady-state temperature in 25°C ambient; (Efficiency will be about 2.0% lower if measured immediately after startup.)
Efficiency at 400 Vac input: SSM-220S530HF I _o =4100 mA I _o =5300 mA	92.0% 92.0%	94.0% 94.0%	- -	Measured at 100% load and steady-state temperature in 25°C ambient; (Efficiency will be about 2.0% lower if measured immediately after startup.)
Efficiency at 480 Vac input: SSM-220S530HF I _o =4100 mA I _o =5300 mA	92.0% 92.5%	94.0% 94.5%	- -	Measured at 100% load and steady-state temperature in 25°C ambient; (Efficiency will be about 2.0% lower if measured immediately after startup.)
Standby Power	-	1.5 W	-	Measured at 480Vac/60Hz; Dimming off
MTBF	-	292,000 Hours	-	Measured at 480Vac input, 80%load and 25°C ambient temperature (MIL-HDBK-217F)
Lifetime	-	120,000 Hours	-	Measured at 480Vac input, 80%load and 70°C case temperature; See lifetime vs. T _c curve for the details
	-	120,000 Hours	-	Measured at 277Vac input, 100%load and 40°C ambient temperature;
Operating Case Temperature for Safety T _{c_s}	-40°C	-	+90°C	
Operating Case Temperature for Warranty T _{c_w}	-40°C	-	+80°C	Case temperature for 5 years warranty Humidity: 10% RH to 95% RH;
Storage Temperature	-40°C	-	+85°C	Humidity: 5%RH to 95%RH
Dimensions Inches (L × W × H) Millimeters (L × W × H)	12.28 × 1.71 × 1.24 312 × 43.5 × 31.5			With mounting ear 13.23 × 1.71 × 1.24 336 × 43.5 × 31.5
Net Weight	-	835 g	-	

Dimming Specifications

Parameter		Min.	Typ.	Max.	Notes
Absolute Maximum Voltage on the Vdim (+) Pin		-20 V	-	20 V	
Source Current on Vdim (+)Pin		90 μ A	100 μ A	110 μ A	Vdim(+) = 0 V
Dimming Output Range	SSM-220S530HF	10%loset	-	loset	4100 mA \leq loset \leq 5300 mA
Recommended Dimming Input Range		0 V	-	10 V	Default 0-10V dimming mode.
Dim off Voltage		0.35 V	0.5 V	0.65 V	
Dim on Voltage		0.55 V	0.7 V	0.85 V	
Hysteresis		-	0.2 V	-	
PWM_in High Level		-	10V	-	
PWM_in Low Level		-	0V	-	
PWM_in Frequency Range		200 Hz	-	3 KHz	
PWM_in Duty Cycle		0%	-	100%	
PWM Dimming off		3%	5%	8%	
PWM Dimming on		5%	7%	10%	
Hysteresis		-	2%	-	

Safety & EMC Compliance

Safety Category	Standard
UL/CUL	UL 8750,CAN/CSA-C22.2 No. 250.13
CE	EN 61347-1, EN 61347-2-13
CB	IEC 61347-1, IEC 61347-2-13
EMI Standards	Notes
EN 55015 ⁽¹⁾	Conducted emission Test &Radiated emission Test
EN 61000-3-2	Harmonic current emissions
EN 61000-3-3	Voltage fluctuations & flicker
FCC Part 15 ⁽¹⁾	ANSI C63.4 Class B
	This device complies with Part 15 of the FCC Rules. Operation is subject to the following two conditions: [1] this device may not cause harmful interference, and [2] this device must accept any interference received, including interference that may cause undesired operation.

Safety & EMC Compliance (Continued)

EMS Standards	Notes
EN 61000-4-2	Electrostatic Discharge (ESD): 8 kV air discharge, 4 kV contact discharge
EN 61000-4-3	Radio-Frequency Electromagnetic Field Susceptibility Test-RS
EN 61000-4-4	Electrical Fast Transient / Burst-EFT
EN 61000-4-5	Surge Immunity Test: AC Power Line: Differential Mode 6 kV, Common Mode 6 kV
EN 61000-4-6	Conducted Radio Frequency Disturbances Test-CS
EN 61000-4-8	Power Frequency Magnetic Field Test
EN 61000-4-11	Voltage Dips
EN 61547	Electromagnetic Immunity Requirements Applies To Lighting Equipment
ANSI Standards	Notes
ANSI C82.77-5	6kV combi-wave surge rating to comply with ANSI C82.77-5 CAT low

Note: (1) This LED driver meets the EMI specifications above, but EMI performance of a Luminaire that contains it depends also on the other devices connected to the driver and on the fixture itself.

Lifetime vs. Case Temperature

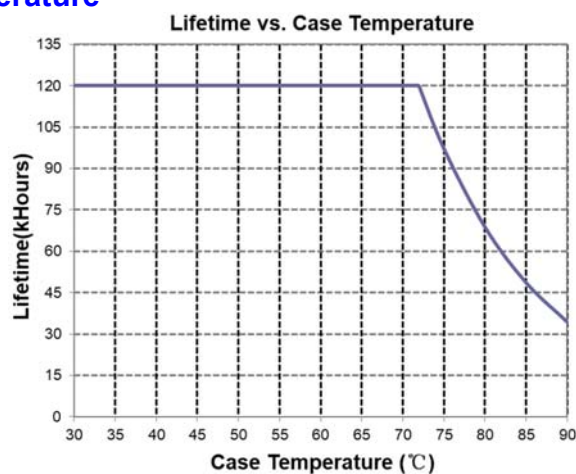

Inrush Current Waveform

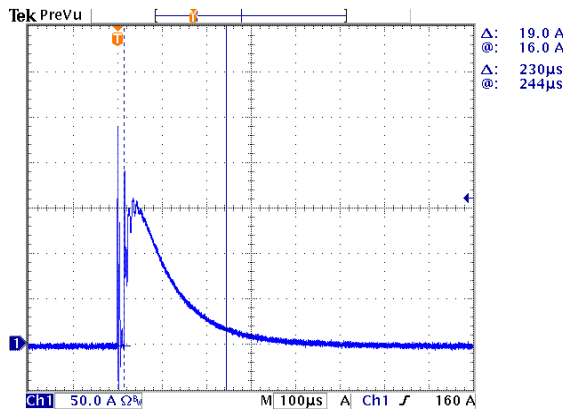

Efficiency vs. Load

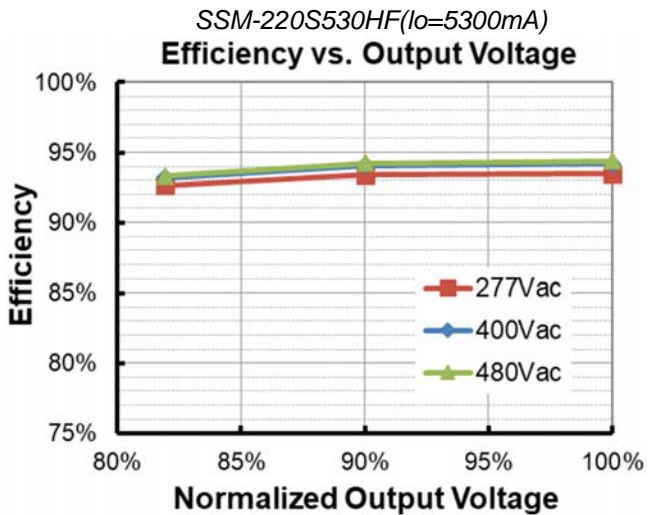
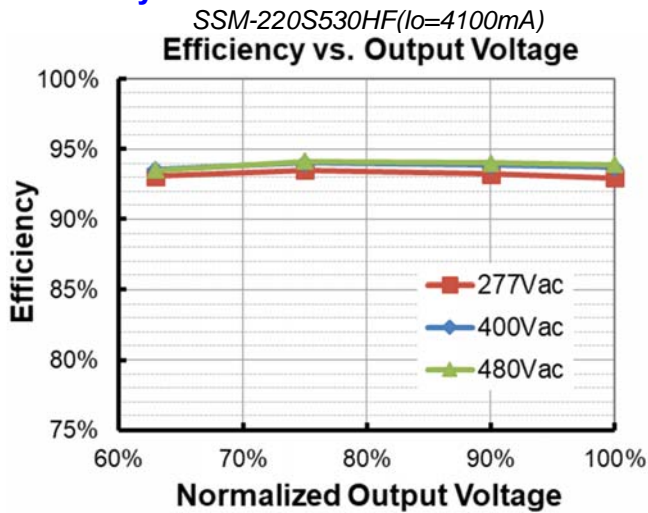

Power Factor

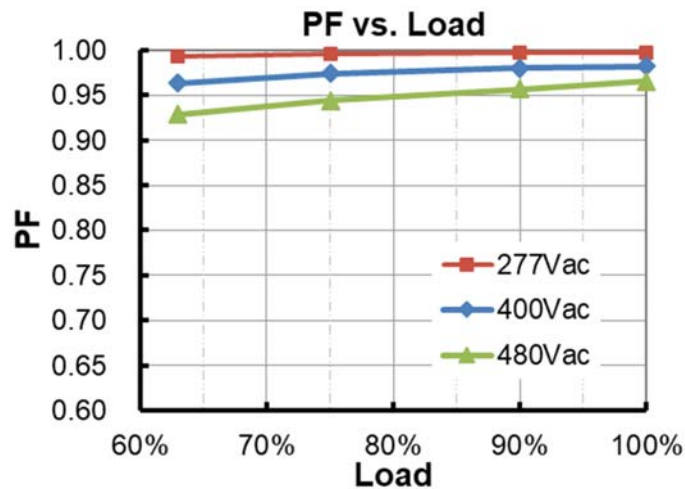

Total Harmonic Distortion

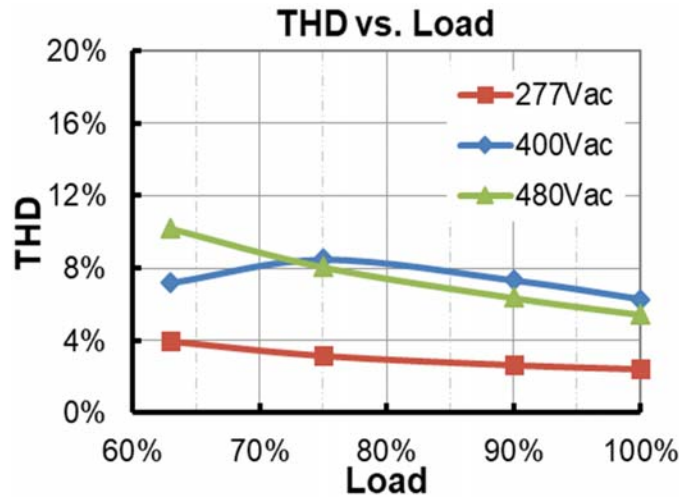

Protection Functions

Parameter	Notes
Over Voltage Protection	Limits output voltage at no load and in case the normal voltage limit fails.
Short Circuit Protection	Auto Recovery. No damage will occur when any output is short circuited. The output shall return to normal when the fault condition is removed.
Over Temperature Protection	Decreases output current, returning to normal after over temperature is removed.

Dimming

● 0-10V Dimming

The recommended implementation of the dimming control is provided below.

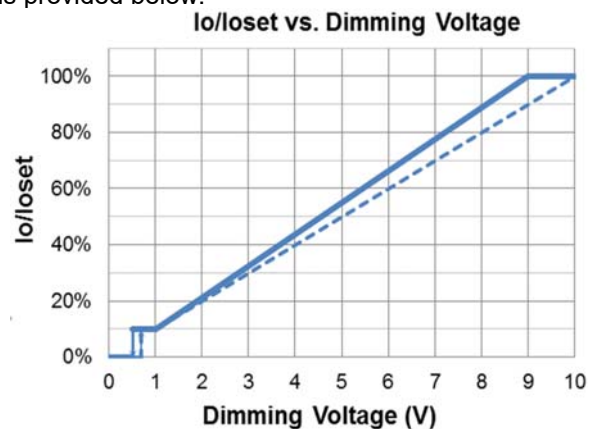
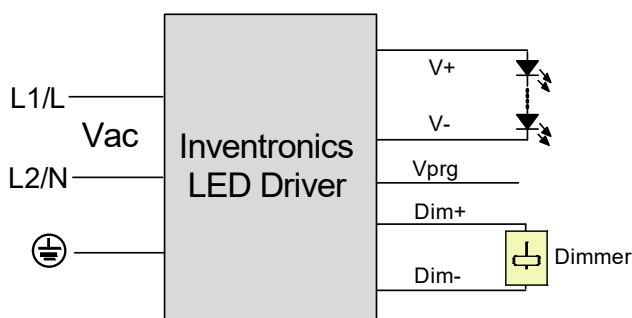

Implementation 1: Positive logic

Notes:

1. Do NOT connect Dim- to the output V- or V+, otherwise the driver will not work properly.
2. The dimmer can also be replaced by an active 0-10V voltage source signal or passive components like zener.

● 10V PWM Dimming

The recommended implementation of the dimming control is provided below.

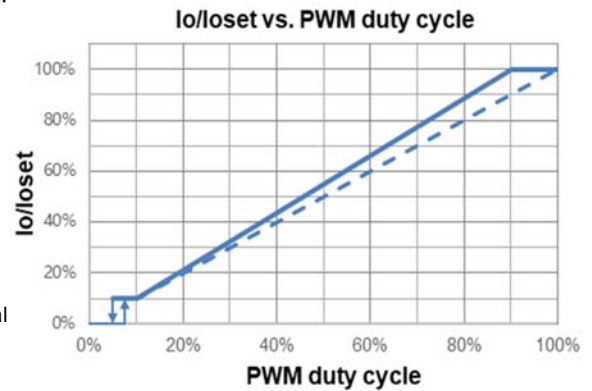
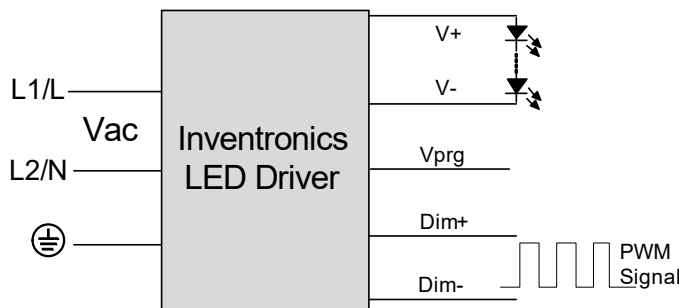

Implementation 2: Positive logic

Notes: Do NOT connect Dim- to the output V- or V+, otherwise the driver will not work properly.

● Resistor Dimming

The recommended implementation of the dimming control is provided below.

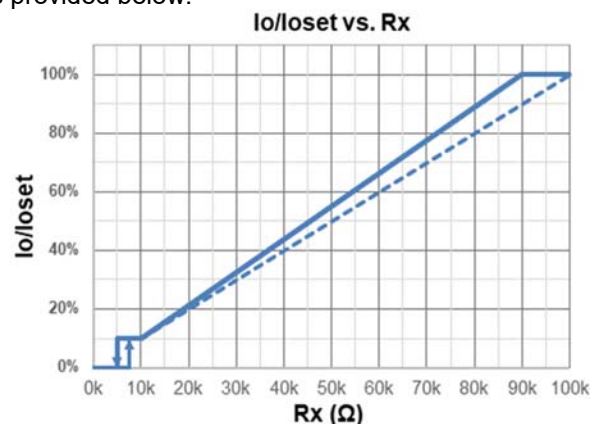
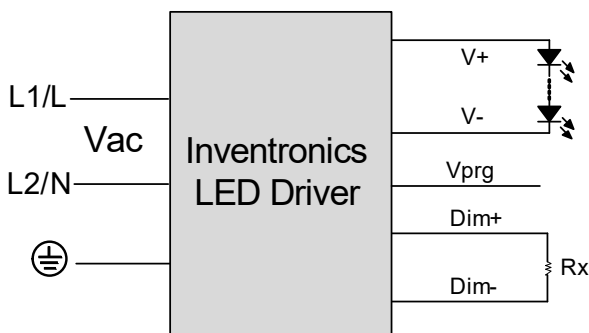

Implementation 3: Positive logic

Notes:

1. Do NOT connect Dim- to the output V- or V+, otherwise the driver will not work properly.

● Output Lumen Compensation

Output Lumen Compensation (OLC) may be used to maintain constant light output over the life of the LEDs by driving them at a reduced current when new, then gradually increasing the drive current over time to counteract LED lumen degradation.

● Maximum Dimming Level with 9V or 10V Selectable

The maximum dimming level can be set as corresponding dimming voltage is 9V or 10V by Inventronics Multi Programmer, 9V is default.

● Fade Time Adjustable

Soft-start time and dimming slope can be adjusted by Inventronics Multi Programmer to get customized fade time experience, disable mode is default.

● **End Of Life**

End-of-Life (EOL) is providing a visual notification to a user that the LED module has reached the end of manufacturer-specified life and that the replacement is recommended. Once active, an indication is given at each power-up of the driver, which the driver indicates this through a lower light output during the first 1 minute before normal operation is continued.

Programming Connection Diagram

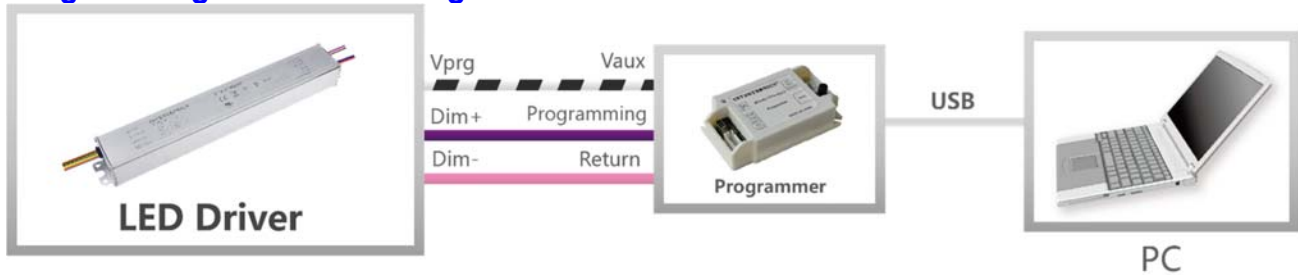

Note: The driver does not need to be powered on during the programming process.

- Please refer to [PRG-MUL2 \(Programmer\) datasheet](#) for details.

Mechanical Outline

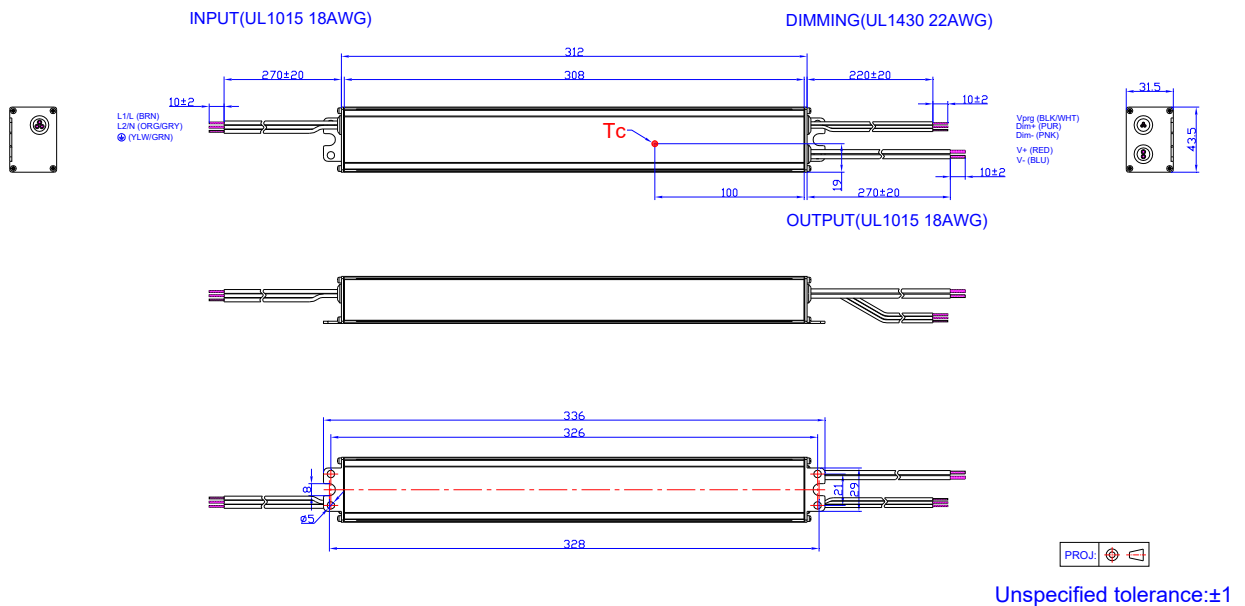

Unspecified tolerance:±1

RoHS Compliance

Our products comply with reference to RoHS Directive (EU) 2015/863 amending 2011/65/EU, calling for the elimination of lead and other hazardous substances from electronic products.

Revision History

Change Date	Rev.	Description of Change		
		Item	From	To
2022-07-05	A	Datasheet Release	/	/