

Features

- Input Over Voltage Protection at 440Vac with 48 Hours
- Low THD, 10% Max up to 240 Vac
- High Efficiency (Up to 91%)
- Input Surge Protection: DM 4kV, CM 6kV
- High Reliability & Long Lifetime: 120,000 Hrs. at 70°C Case Temperature
- Adjustable Output Current (AOC) by Potentiometer
- Suitable for Class I Luminaires
- IUVP & IOVP
- IP66/IP67
- 5 Years Warranty



Description

The EDC-100S105SV2 is a 100W, constant-current, AOC LED driver that operates from 140-305 Vac input with excellent power factor. It is created for high bay, tunnel and street lights. The high efficiency of these drivers and compact metal case enable them to run cooler, significantly improving reliability and extending product life. To ensure trouble-free operation, protection is provided against input surge, input under voltage, input over voltage, output over voltage, short circuit, and over temperature.

Models

Output Current Range (mA)	Output Voltage Range (Vdc)	Max. Output Power (W)	Typical Efficiency ⁽¹⁾	Typical Power Factor ⁽¹⁾	Model Number ⁽²⁾⁽³⁾
700-1050	47-143	100	91.0%	0.96	EDC-100S105SV2

Notes: (1) Measured at 100% load and 220Vac input.

(2) Certified input voltage range: 220-240Vac.

(3) Operating input voltage range: 100-305Vac, and 100-140Vac is for safety operation.

Operating Area

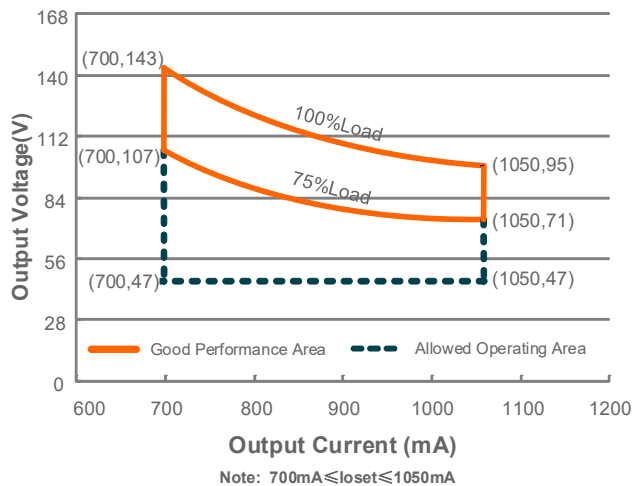

Input Specifications

Parameter	Min.	Typ.	Max.	Notes
Input Voltage	140 Vac	-	305 Vac	
Input Frequency	47 Hz	-	63 Hz	
Leakage Current	-	-	0.70 mA	IEC 60598-1; 240Vac/60Hz
Input AC Current	-	-	0.55 A	Measured at 100% load and 220 Vac input.
Inrush Current(I ² t)	-	-	0.005 A ² s	At 220Vac input, 25°C cold start, duration=47.2 μs, 10%I _{pk} -10%I _{pk} .
PF	0.90	-	-	At 200-277Vac, 50-60Hz, 75%-100%load (75~100W)
THD	-	-	20%	
THD	-	-	10%	At 220-240Vac, 50-60Hz, 75%-100%load (75~100W)

Output Specifications

Parameter	Min.	Typ.	Max.	Notes
Output Current Tolerance	-8%lo	-	8%lo	At 100% load condition.
Output Current Setting (I _o set) Range				
EDC-100S105SV2	700 mA	-	1050 mA	
Startup Overshoot Current	-	-	10%I _o max	At 100% load condition
No Load Output Voltage				
EDC-100S105SV2	-	-	200 V	
Line Regulation	-	-	±5.0%	Measured at 100% load
Load Regulation	-	-	±5.0%	
Turn-on Delay Time	-	-	0.5 s	Measured at 220Vac input, 75%-100%load
Temperature Coefficient of I _o max	-	0.06%/°C	-	Case temperature = 0°C~T _c max

Note: All specifications are tested by Cree XLamp XP-G2 unless otherwise stated.

General Specifications

Parameter	Min.	Typ.	Max.	Notes
Efficiency at 220 Vac input: EDC-100S105SV2				Measured at 100% load and steady-state temperature in 25°C ambient; (Efficiency will be about 2.0% lower if measured immediately after startup.)
I _o = 700 mA	89.0%	91.0%	-	
I _o =1050 mA	88.0%	90.0%	-	
MTBF	-	501,000 Hours	-	Measured at 220Vac input, 80%Load and 25°C ambient temperature (MIL-HDBK-217F)
Lifetime	-	120,000 Hours	-	Measured at 220Vac input, 80%Load and 70°C case temperature; See lifetime vs. T _c curve for the details

General Specifications (Continued)

Parameter	Min.	Typ.	Max.	Notes
Operating Case Temperature for Safety T _{c_s}	-40°C	-	+90°C	
Operating Case Temperature for Warranty T _{c_w}	-40°C	-	+75°C	Case temperature for 5 years warranty. Humidity: 10%RH to 95%RH
Storage Temperature	-40°C	-	+85°C	Humidity: 5%RH to 95%RH
Dimensions Inches (L × W × H) Millimeters (L × W × H)	5.71 x 2.66 x 1.44 145 x 67.5 x 36.5			With mounting ear 6.54 x 2.66 x 1.44 166 x 67.5 x 36.5
Net Weight	-	730 g	-	

Note: All specifications are tested by Cree XLamp XP-G2 unless otherwise stated.

Safety & EMC Compliance

Safety Category	Standard
CE	EN 61347-1, EN61347-2-13
CB	IEC 61347-1, IEC 61347-2-13
KS	KS C 7655
EMI Standards	Notes
EN IEC 55015 ⁽¹⁾	Conducted emission Test & Radiated emission Test
EN IEC 61000-3-2	Harmonic current emissions
EN 61000-3-3	Voltage fluctuations & flicker
EMS Standards	Notes
EN 61000-4-2	Electrostatic Discharge (ESD): 8 kV air discharge, 4 kV contact discharge
EN 61000-4-3	Radio-Frequency Electromagnetic Field Susceptibility Test-RS
EN 61000-4-4	Electrical Fast Transient / Burst-EFT
EN 61000-4-5	Surge Immunity Test: AC Power Line: Differential Mode 4 kV, Common Mode 6 kV
EN 61000-4-6	Conducted Radio Frequency Disturbances Test-CS
EN 61000-4-8	Power Frequency Magnetic Field Test
EN 61000-4-11	Voltage Dips
EN 61547	Electromagnetic Immunity Requirements Applies To Lighting Equipment

Note: (1) This LED driver meets the EMI specifications above, but EMI performance of a luminaire that contains it depends also on the other devices connected to the driver and on the fixture itself.

Derating

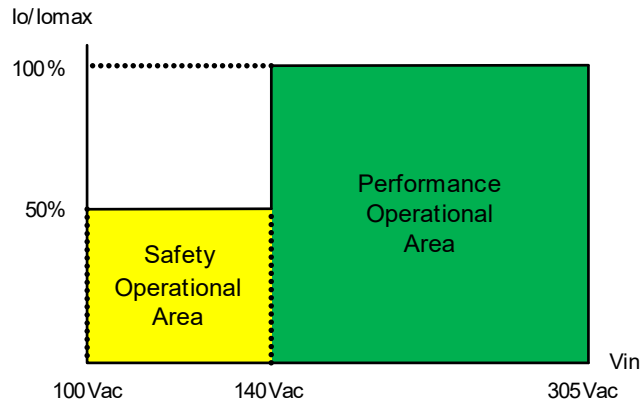

Lifetime vs. Case Temperature

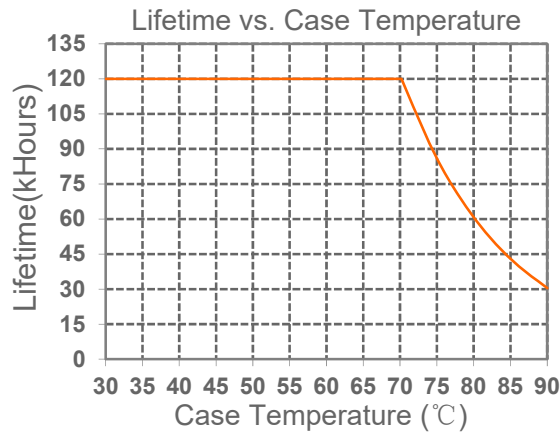

Inrush Current Waveform

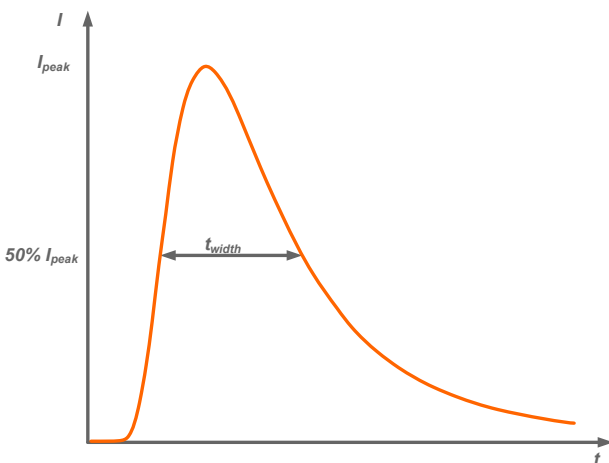

Input AC Voltage	I_{peak}	t_{width} (@ 50% I_{peak})
220 Vac	12.4 A	34.4 us

Inrush Current Waveform (Continued)

MCB	Tripping Curves	B	B	B	B	C	C	C	C
	Rated Current	10A	16A	20A	25A	10A	16A	20A	25A
The Number of LED Driver can be Configured	220Vac	11	18	23	29	13	21	27	34

Efficiency vs. Load

EDC-100S105SV2(Io=700mA)

Efficiency vs. Output Voltage

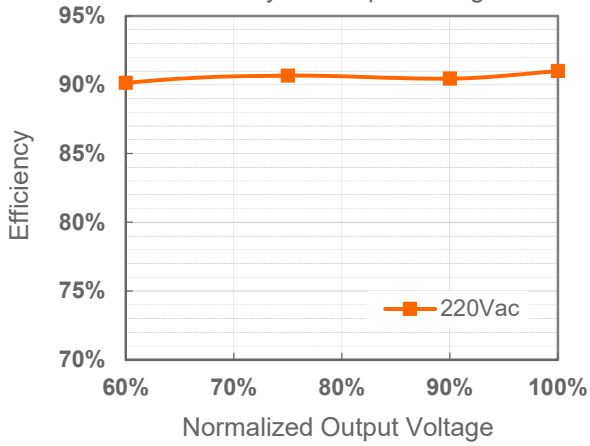

EDC-100S105SV2(Io=1050mA)

Efficiency vs. Output Voltage

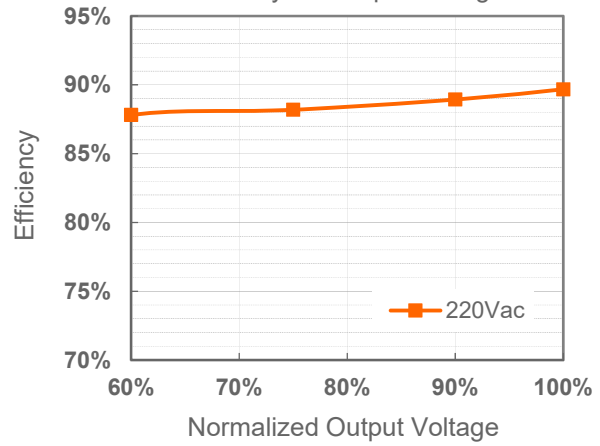

Power Factor

PF vs. Load

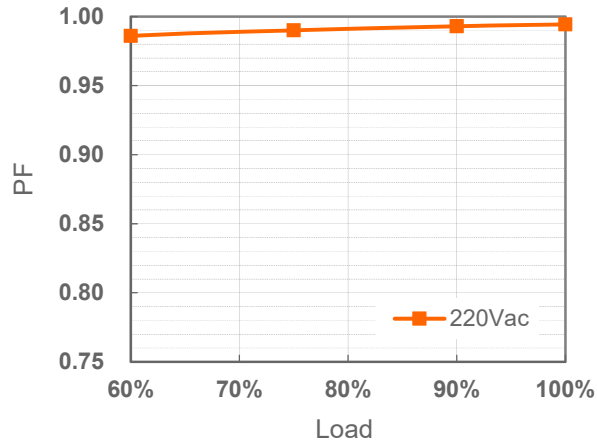

Total Harmonic Distortion

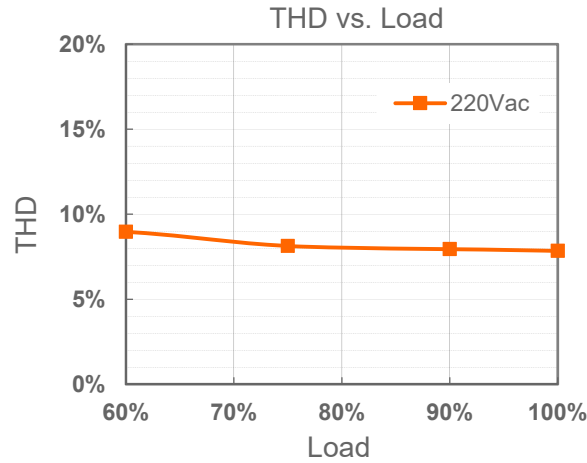

Protection Functions

Parameter		Min.	Typ.	Max.	Notes
Over Voltage Protection		Limits output voltage at no load and in case the normal voltage limit fails.			
Short Circuit Protection		Auto Recovery. No damage will occur when any output is short circuited. The output shall return to normal when the fault condition is removed.			
Over Temperature Protection		Decreases output current, returning to normal after over temperature is removed.			
Input Under Voltage Protection		Auto Recovery. Shut down when the input voltage falls below 100V. And the driver will restart when the input voltage is in normal.			
Input Over Voltage Protection	Input Protection Voltage	320 Vac	340 Vac	360 Vac	Turn off the output when the input voltage exceeds protection voltage.
	Input Recovery Voltage	300 Vac	320 Vac	340 Vac	Auto Recovery. The driver will restart when the input voltage falls below recovery voltage.
	Max. of Input Over Voltage	-	-	440 Vac	The driver can survive for 48 hours with input over voltage of 440Vac.

● Input Over Voltage Protection Diagram

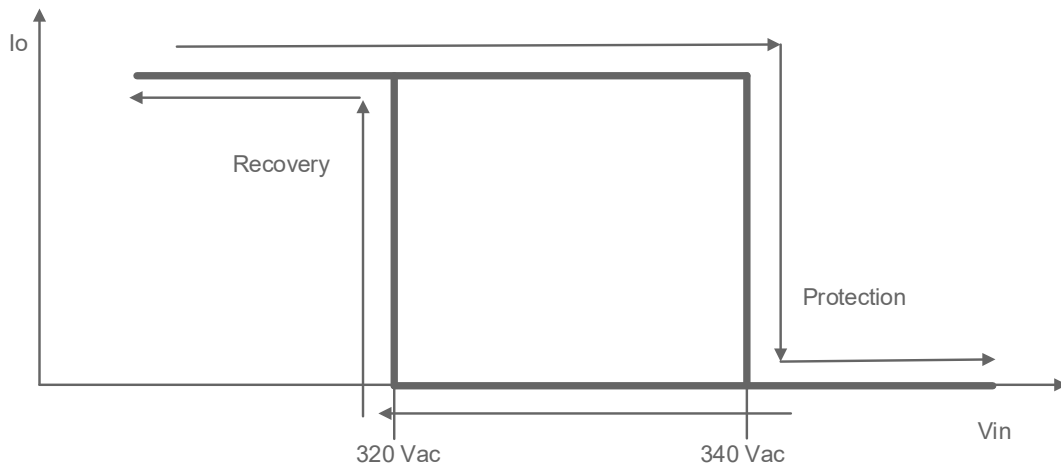

Output Current vs. Potentiometer Setting

Output Current Setting (I _o set)	Output Voltage Range		Notes
Typ.	Min.	Max.	/
1050mA	47V	95V	Output Current Setting with Constant Power
...	
700mA	47V	143V	

Mechanical Outline

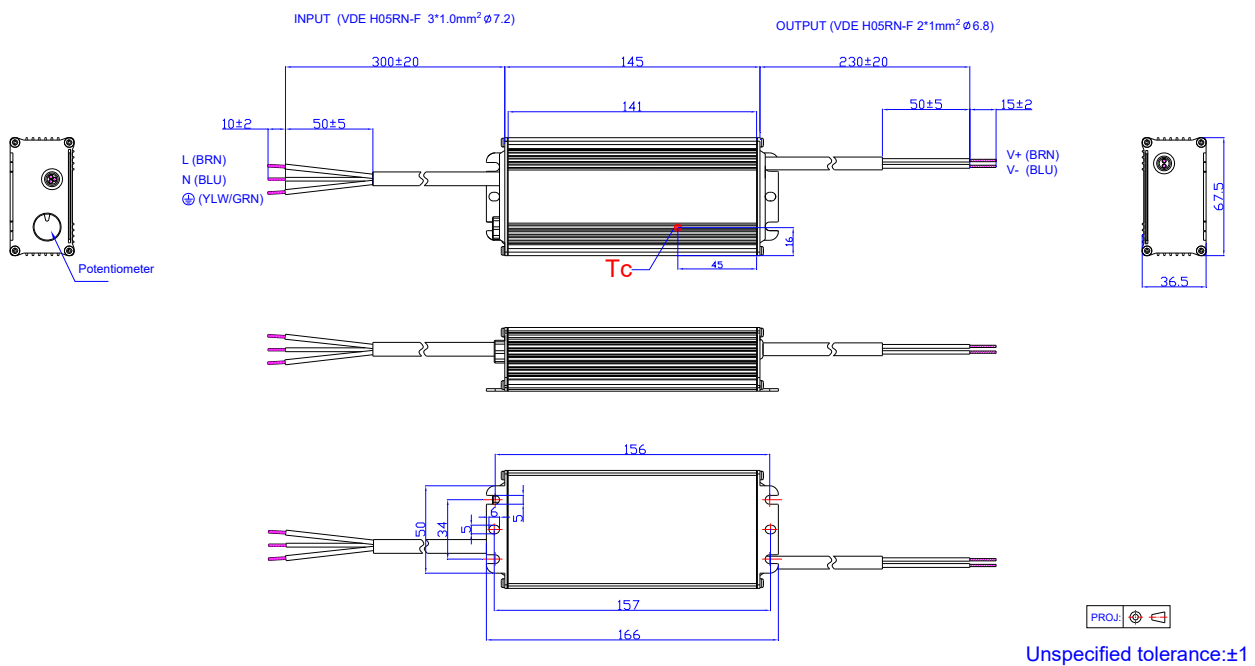

RoHS Compliance

Our products comply with reference to RoHS Directive (EU) 2015/863 amending 2011/65/EU, calling for the elimination of lead and other hazardous substances from electronic products.

Revision History

Change Date	Rev.	Description of Change		
		Item	From	To
2022-11-10	A	Datasheets Release	/	/
2023-08-31	B	Features	/	Updated
		Protection Functions	/	Updated
2024-09-26	C	Format	/	Updated
		Inrush Current Waveform	/	Updated