

Features

- Panel Mount Connectors Facilitates Installation
- Hot-plugging Protection
- Parallel LED Protection
- Ultra High Efficiency (Up to 96.0%)
- Full Power at Wide Output Current Range (Constant Power)
- Adjustable Output Current (AOC) with Programmability
- Isolated 0-10V/PWM/Resistor/3-Timer-Modes Dimmable
- Adjustable Dimming Curve
- INV Digital Dimming, UART Based Communication Protocol
- Dim-to-Off
- Minimum Dimming Level with 5% or 10% Selectable
- Hold Time Adjustable
- Fade Time Adjustable
- Always-on Auxiliary Power: 12Vdc, 250mA
- Low Inrush Current
- Output Lumen Compensation
- End-of-Life Indicator
- Input Surge Protection: DM 6kV, CM 10kV
- All-Around Protection: IOVP, IUVP, OVP, SCP, OTP
- IP66/IP67 and UL Dry/Damp/Wet Location
- TYPE HL, for Use in a Class I, Division 2 Hazardous (Classified) Location
- 5 Years Warranty



Description

The SSM-1K0SxxxMGS series is a 1000W, constant-current, programmable and IP66/IP67 rated LED driver that operates from 249-528Vac input with excellent power factor. Created for many lighting applications including high mast, sports, UV-LED, aquaculture and horticulture, etc. It provides an auxiliary voltage and dim-to-off functionality for powering low voltage, wireless controls. The dimming control supports 0-10V dimming as well as two-way communication via Digital Dimming, a UART based communication protocol. The high efficiency of these drivers and compact metal case enables them to run cooler, significantly improving reliability and extending product life. To ensure trouble-free operation, protection is provided against input surge, input under voltage, input over voltage, output over voltage, short circuit, and over temperature.

Models

Adjustable Output Current Range(A)	Full-Power Current Range(A) ⁽¹⁾	Default Output Current(A)	Output Voltage Range(Vdc)	Max. Output Power(W)	Typical Efficiency ⁽²⁾	Typical Power Factor		Model Number ⁽³⁾
						277Vac	480Vac	
0.32-4	3.2-4	3.3	175-312	1000	96.0%	0.99	0.96	SSM-1K0S400MGS
0.672-8.4	6.72-8.4	7.7	84-149	1000	95.5%	0.99	0.96	SSM-1K0S840MGS
1.85-20	18.5-20	18.5	34-54	1000	96.0%	0.99	0.96	SSM-1K0S20AMGS ⁽⁴⁾

- Notes:** (1) Output current range with constant power at 1000W.
 (2) Measured at 100% load and 480Vac input (see below "General Specifications" for details).
 (3) Certified input voltage range: 277-480Vac
 (4) SELV output

I-V Operating Area

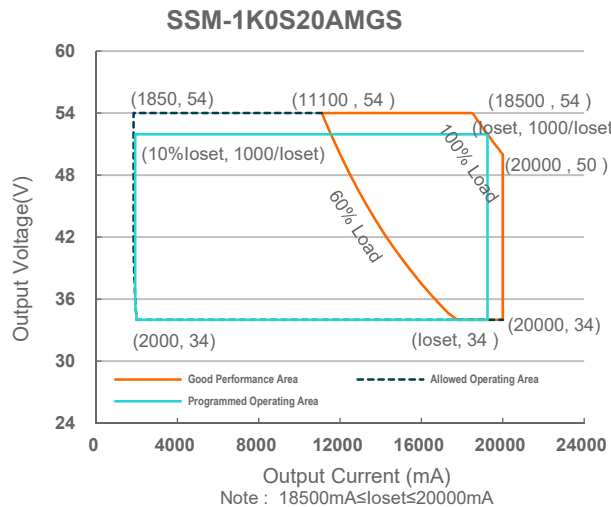
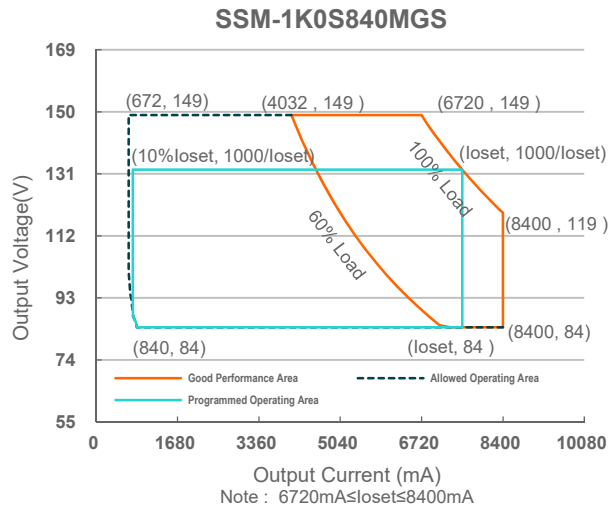
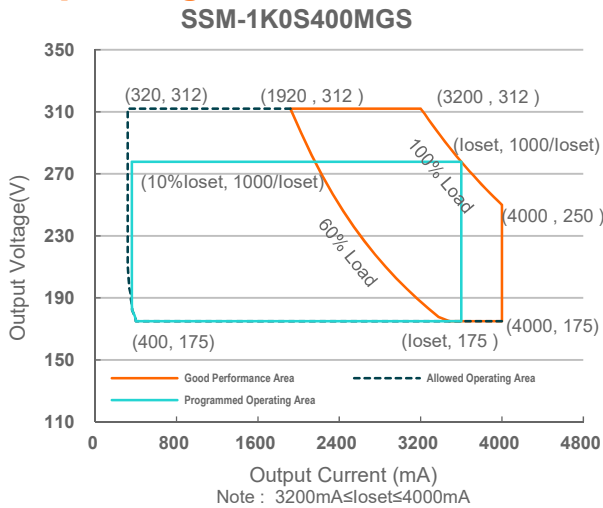

Input Specifications

Parameter	Min.	Typ.	Max.	Notes
Input AC Voltage	249 Vac	-	528 Vac	
Input DC Voltage	352 Vdc	-	500 Vdc	
Input Frequency	47 Hz	-	63 Hz	
Leakage Current	-	-	0.75 MIU	UL 8750; 480Vac/60Hz
			0.70 mA	IEC 60598-1; 480Vac/60Hz

Input Specifications (Continued)

Parameter	Min.	Typ.	Max.	Notes
Input AC Current	-	-	4.29 A	Measured at 100% load and 277 Vac input.
	-	-	2.53 A	Measured at 100% load and 480 Vac input.
Inrush Current(I ² t)	-	-	1.80 A ² s	At 480Vac input, 25°C cold start, duration=11.9ms, 10%l _{pk} -10%l _{pk} .
PF	0.90	-	-	At 277-480Vac, 50-60Hz,60%-100%Load (600 - 1000W)
THD	-	-	20%	

Output Specifications

Parameter	Min.	Typ.	Max.	Notes
Output Current Tolerance	-5%loset	-	5%loset	100% load
Output Current Setting(loset Range)				
SSM-1K0S400MGS	320 mA	-	4000 mA	
SSM-1K0S840MGS	672 mA	-	8400 mA	
SSM-1K0S20AMGS	1850 mA	-	20000 mA	
Output Current Setting Range with Constant Power				
SSM-1K0S400MGS	3200 mA	-	4000 mA	
SSM-1K0S840MGS	6720 mA	-	8400 mA	
SSM-1K0S20AMGS	18500 mA	-	20000 mA	
Total Output Current Ripple (pk-pk)	-	5%lomax	10%lomax	100% load, 20 MHz BW
Output Current Ripple at < 200 Hz (pk-pk)	-	-	2%lomax	70%-100% load
Startup Overshoot Current	-	-	10%lomax	100% load
No Load Output Voltage				
SSM-1K0S400MGS	-	-	350 V	
SSM-1K0S840MGS	-	-	170 V	
SSM-1K0S20AMGS	-	-	60 V	
Line Regulation	-	-	±0.5%	100% load
Load Regulation	-	-	±3.0%	
Turn-on Delay Time	-	-	0.5 s	Measured at 277-480Vac input, 60%-100% Load
Temperature Coefficient of loset	-	0.03%/°C	-	Case temperature = 0°C ~T _c max
12V Auxiliary Output Voltage	10.8 V	12 V	13.2 V	
12V Auxiliary Output Source Current	0 mA	-	250 mA	Return terminal is "Dim"
12V Auxiliary Output Transient Peak Current@6W	-	-	500 mA	500mA peak for a maximum duration of 2.2 ms in a 6.0ms period during which time the average should not exceed 250mA.
12V Auxiliary Output Transient Peak Current@10W	-	-	850 mA	850mA peak for a maximum duration of 1.3 ms in a 5.2ms period during which time the average should not exceed 250mA.

General Specifications

Parameter	Min.	Typ.	Max.	Notes
Efficiency at 277 Vac input: SSM-1K0S400MGS Io= 3200 mA Io= 4000 mA SSM-1K0S840MGS Io= 6720 mA Io= 8400 mA SSM-1K0S20AMGS Io= 18500 mA Io= 20000 mA	93.0% 93.0%	95.0% 95.0%	- -	Measured at 100% load and steady-state temperature in 25°C ambient; (Efficiency will be about 2.0% lower if measured immediately after startup.)
Efficiency at 400 Vac input: SSM-1K0S400MGS Io= 3200 mA Io= 4000 mA SSM-1K0S840MGS Io= 6720 mA Io= 8400 mA SSM-1K0S20AMGS Io= 18500 mA Io= 20000 mA	93.5% 93.5%	95.5% 95.5%	- -	
Efficiency at 480 Vac input: SSM-1K0S400MGS Io= 3200 mA Io= 4000 mA SSM-1K0S840MGS Io= 6720 mA Io= 8400 mA SSM-1K0S20AMGS Io= 18500 mA Io= 20000 mA	94.0% 94.0%	96.0% 96.0%	- -	Measured at 100% load and steady-state temperature in 25°C ambient; (Efficiency will be about 2.0% lower if measured immediately after startup.)
Standby Power	-	1.5 W		
MTBF	-	200,000 Hours	-	Measured at 480Vac input, 80%Load and 25°C ambient temperature (MIL-HDBK-217F)
Lifetime	-	100,000 Hours	-	Measured at 480Vac input, 80%Load and 70°C case temperature; See lifetime vs. Tc curve for the details
	-	50,000 Hours	-	Measured at 277Vac input, 100%Load and 40°C ambient temperature
Operating Case Temperature for Safety Tc_s	-40°C	-	+90°C	
Operating Case Temperature for Warranty Tc_w	-40°C	-	+80°C	Case temperature for 5 years warranty Humidity: 10%RH to 95%RH
Storage Temperature	-40°C	-	+85°C	Humidity: 5%RH to 95%RH
Dimensions Inches (L × W × H) Millimeters (L × W × H)	16.73 × 4.25 × 1.91 425 × 108 × 48.5			With mounting ear 17.72 × 4.25 × 1.91 450 × 108 × 48.5
Net Weight	-	3710 g	-	

Dimming Specifications

Parameter		Min.	Typ.	Max.	Notes
Absolute Maximum Voltage on the Vdim (+) Pin		-20 V	-	20 V	
Source Current on Vdim (+)Pin		90 uA	100 uA	110 uA	Vdim(+) = 0 V
Dimming Output Range with 10%-100% (Default)	SSM-1K0S400MGS	10%loset	-	loset	3200 mA ≤ I _o set ≤ 4000 mA
	SSM-1K0S840MGS				6720 mA ≤ I _o set ≤ 8400 mA
	SSM-1K0S20AMGS				18500 mA ≤ I _o set ≤ 20000 mA
Dimming Output Range with 5%-100% (Settable)	SSM-1K0S400MGS	5%loset	-	loset	320 mA ≤ I _o set ≤ 3200 mA
	SSM-1K0S840MGS				672 mA ≤ I _o set ≤ 6720 mA
	SSM-1K0S20AMGS				1850 mA ≤ I _o set < 18500 mA
Recommended Dimming Input Range		0 V	-	10 V	Default 0-10V dimming mode.
Dim off Voltage		0.35 V	0.5 V	0.65 V	
Dim on Voltage		0.55 V	0.7 V	0.85 V	
Hysteresis		-	0.2 V	-	
PWM_in High Level		3 V	-	10 V	Dimming mode set to PWM in Inventronics Programing Software.
PWM_in Low Level		-0.3 V	-	0.6 V	
PWM_in Frequency Range		200 Hz	-	3 KHz	
PWM_in Duty Cycle		1%	-	99%	
PWM Dimming off (Positive Logic)		3%	5%	8%	
PWM Dimming on (Positive Logic)		5%	7%	10%	
PWM Dimming off (Negative Logic)		92%	95%	97%	
PWM Dimming on (Negative Logic)		90%	93%	95%	
Hysteresis		-	2%	-	

Safety &EMC Compliance

Safety Category	Standard
UL/CUL	UL 8750,CAN/CSA-C22.2 No. 250.13
CE	EN 61347-1, EN 61347-2-13
CB	IEC 61347-1, IEC 61347-2-13
EMI Standards	Notes
EN IEC 55015 ⁽¹⁾	Conducted emission Test &Radiated emission Test

Safety & EMC Compliance (Continued)

EMI Standards	Notes
EN IEC 61000-3-2	Harmonic current emissions
EN 61000-3-3	Voltage fluctuations & flicker
FCC Part 15 ⁽¹⁾	ANSI C63.4 Class B
	This device complies with Part 15 of the FCC Rules. Operation is subject to the following two conditions: [1] this device may not cause harmful interference, and [2] this device must accept any interference received, including interference that may cause undesired Operation.
EMS Standards	Notes
EN 61000-4-2	Electrostatic Discharge (ESD): 8 kV air discharge, 4 kV contact discharge
EN 61000-4-3	Radio-Frequency Electromagnetic Field Susceptibility Test-RS
EN 61000-4-4	Electrical Fast Transient / Burst-EFT
EN 61000-4-5	Surge Immunity Test: AC Power Line: Differential Mode 6 kV, Common Mode 10 kV
EN 61000-4-6	Conducted Radio Frequency Disturbances Test-CS
EN 61000-4-8	Power Frequency Magnetic Field Test
EN 61000-4-11	Voltage Dips
EN 61547	Electromagnetic Immunity Requirements Applies To Lighting Equipment

Note: (1) This LED driver meets the EMI specifications above, but EMI performance of a luminaire that contains it depends also on the other devices connected to the driver and on the fixture itself.

Lifetime vs. Case Temperature

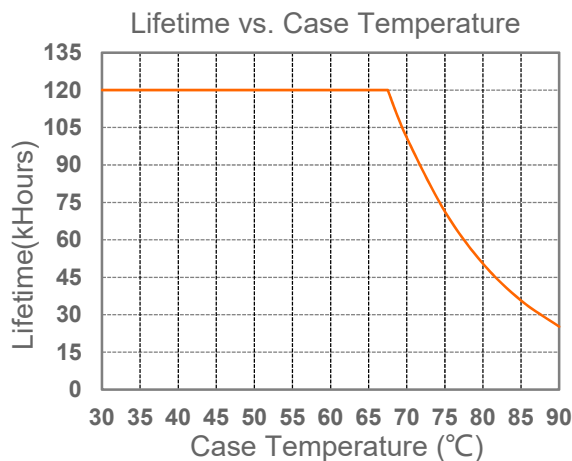

Inrush Current Waveform

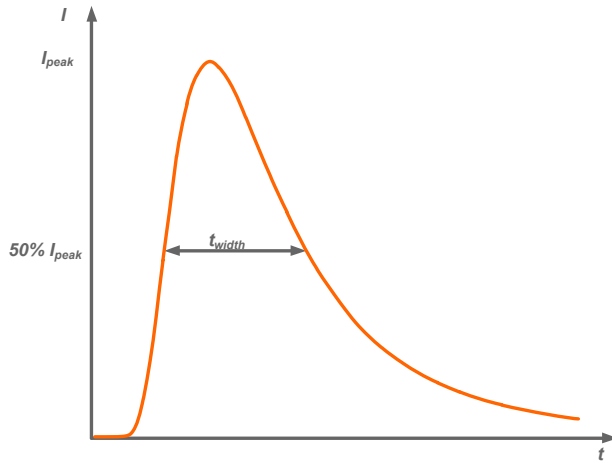

Input AC Voltage	I_{peak}	t_{width} (@ 50% I_{peak})
480V	14.2A	3.72ms

Efficiency vs. Load

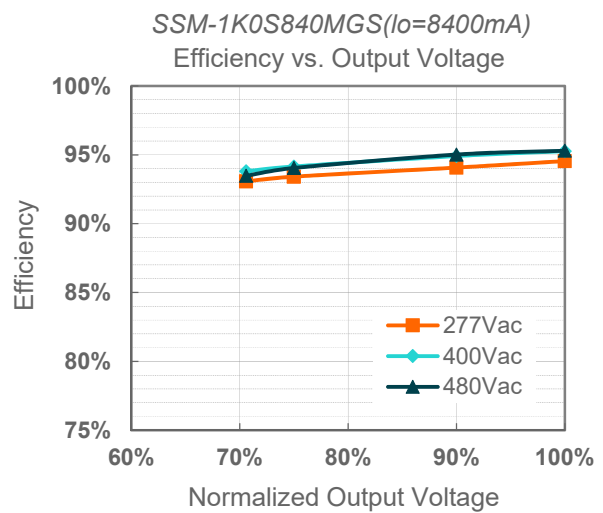
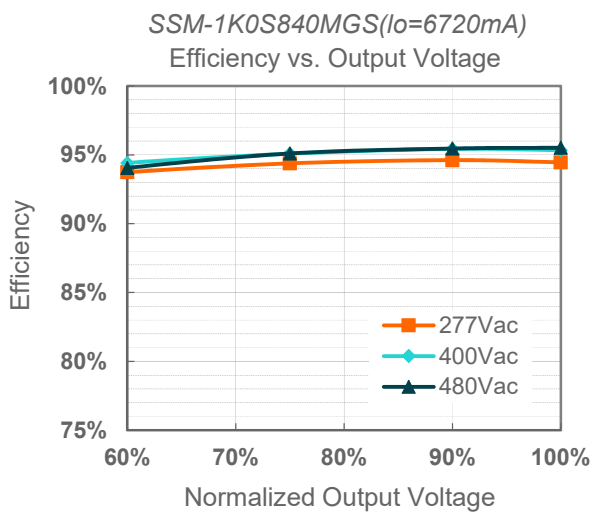
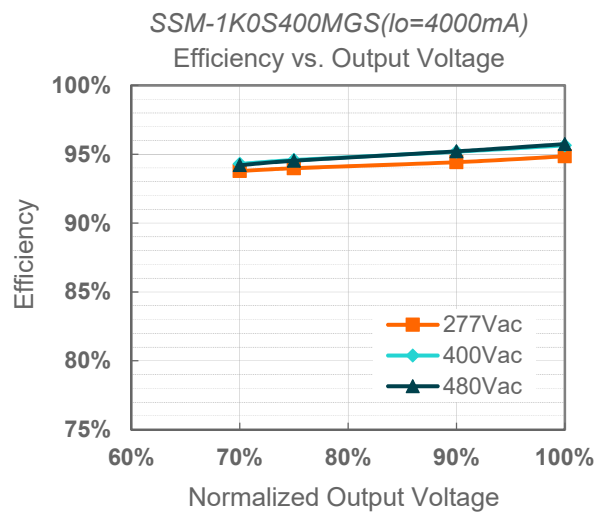
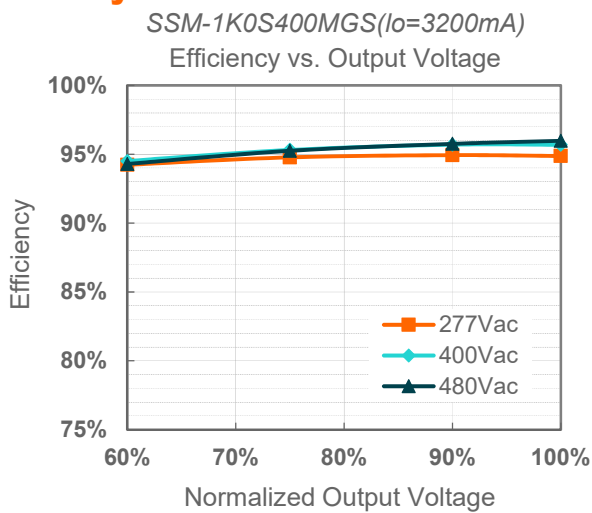

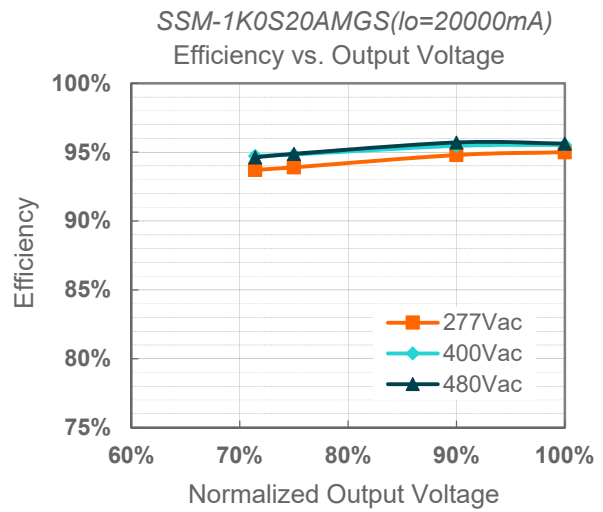
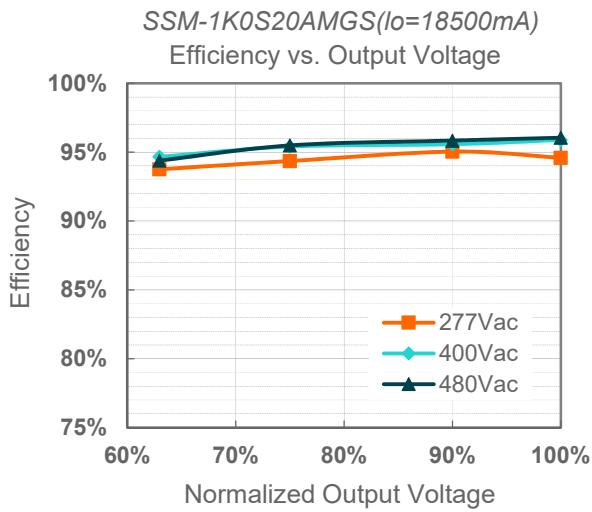

Power Factor

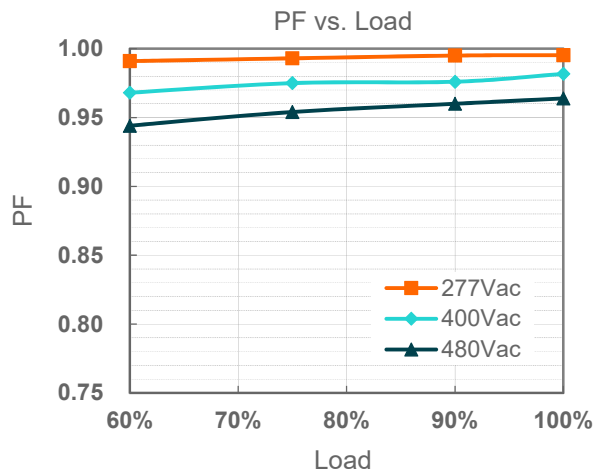

Total Harmonic Distortion

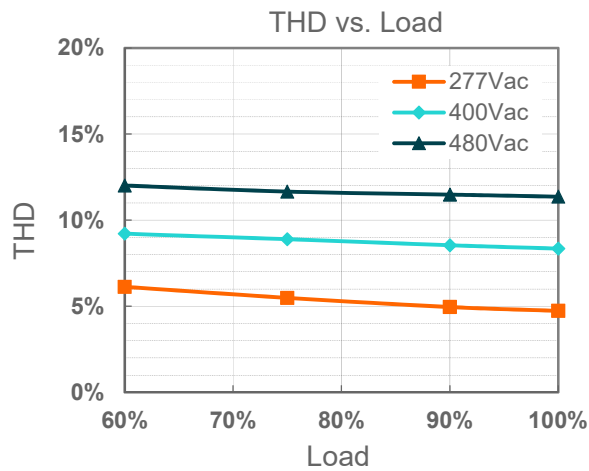

Hot-plugging Protection

This feature protects LEDs when connecting to a driver that is already powered on. This is disabled by default and can be enabled through the Inventronics Programming software.

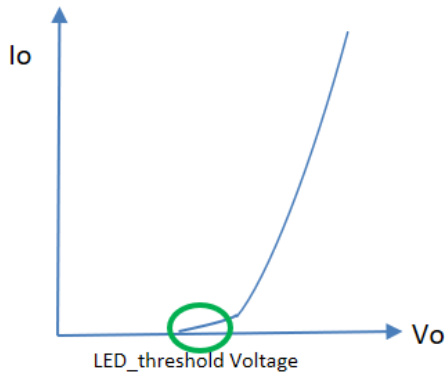

LED threshold voltage (V_{th}) is the minimum voltage required for current to flow through the LED load. After this threshold is met, the LED forward voltage (V_f) increases as the current increases.

Set V_{th} close to, but higher than the actual LED threshold voltage for optimized performance. The greater the difference between the V_{th} setting and the actual LED threshold voltage, the higher the overshoot current will be. The V_{th} setting must be lower than V_f .

Please test, program, and tune this feature for each LED load design.

Parameter		Min.	Typ.	Max.	Notes	
Hot-plugging Protection	LED Threshold Voltage Setting Range	SSM-1K0S400MGS	175 V	-	312 V	Set V_{th} close to, but higher than the actual LED threshold voltage
		SSM-1K0S840MGS	84 V	-	149 V	
		SSM-1K0S20AMGS	44 V	-	54 V	
Setting Tolerance		-2%	-	2%		

Parallel LED Protection

This feature helps protect parallel LEDs from a high, overcurrent condition by limiting the voltage. This is disabled by default and can be enabled through the Inventronics Programming software.

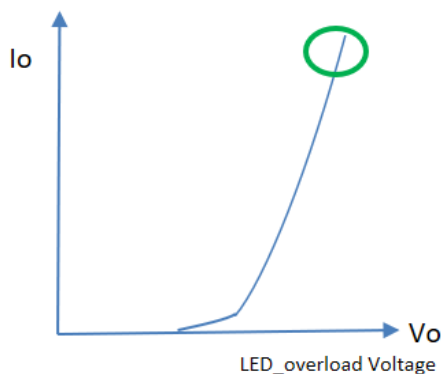

Set $V_{overload}$ close to, but higher than the maximum forward voltage for optimized performance. The greater the difference between the $V_{overload}$ setting and the maximum forward voltage, the higher the overload stress will be. The $V_{overload}$ setting must be higher than V_f .

Please test, program, and tune this feature for each LED load design.

Parallel LED Protection (Continued)

Parameter		Min.	Typ.	Max.	Notes	
Parallel LED Protection	Overload Voltage Setting Range	SSM-1K0S400MGS	175 V	-	325 V	Set V_{overload} close to, but higher than the maximum LED forward voltage
		SSM-1K0S840MGS	90 V	-	155 V	
		SSM-1K0S20AMGS	47 V	-	56 V	
	Setting Tolerance		-2%	-	2%	

Protection Functions

Parameter		Min.	Typ.	Max.	Notes
Over Temperature Protection		Decreases output current, returning to normal after over temperature is removed.			
Short Circuit Protection		Auto Recovery. No damage will occur when any output is short circuited. The output shall return to normal when the fault condition is removed.			
Over Voltage Protection		Limits output voltage at no load and in case the normal voltage limit fails.			
Input Under Voltage Protection (IUVP)	Input Protection Voltage	220 Vac	230 Vac	240 Vac	Turn off the output when the input voltage falls below protection voltage.
	Input Recovery Voltage	230 Vac	240 Vac	250 Vac	Auto Recovery. The driver will restart when the input voltage exceeds recovery voltage.
Input Over Voltage Protection (IOVP)	Input Over Voltage Protection	550 Vac	570 Vac	590 Vac	Turn off the output when the input voltage exceeds protection voltage.
	Input Over Voltage Recovery	530 Vac	550 Vac	570 Vac	Auto Recovery. The driver will restart when the input voltage falls below recovery voltage.
	Max. of Input Over Voltage			590 Vac	The driver can survive for 8 hours with a stable input voltage stress of 590Vac.

● Input Under Voltage Protection Diagram

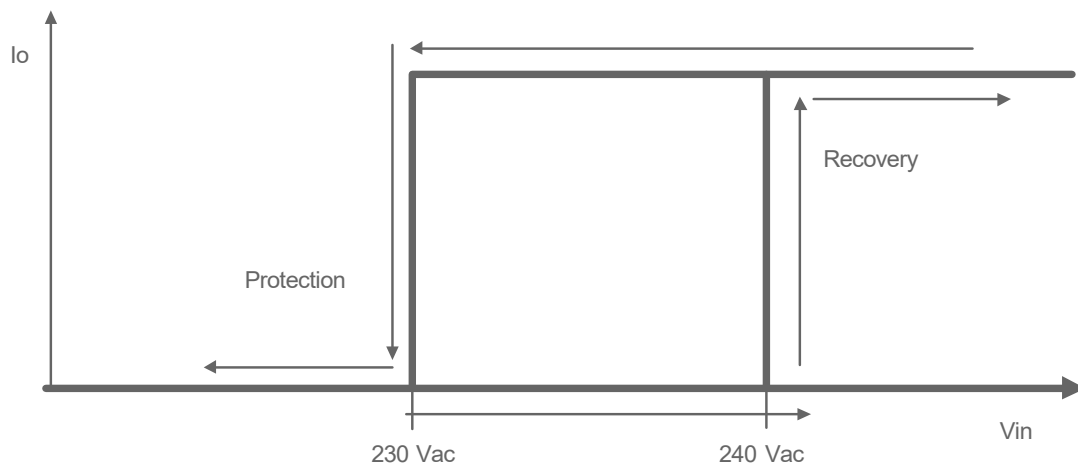

● Input Over Voltage Protection Diagram

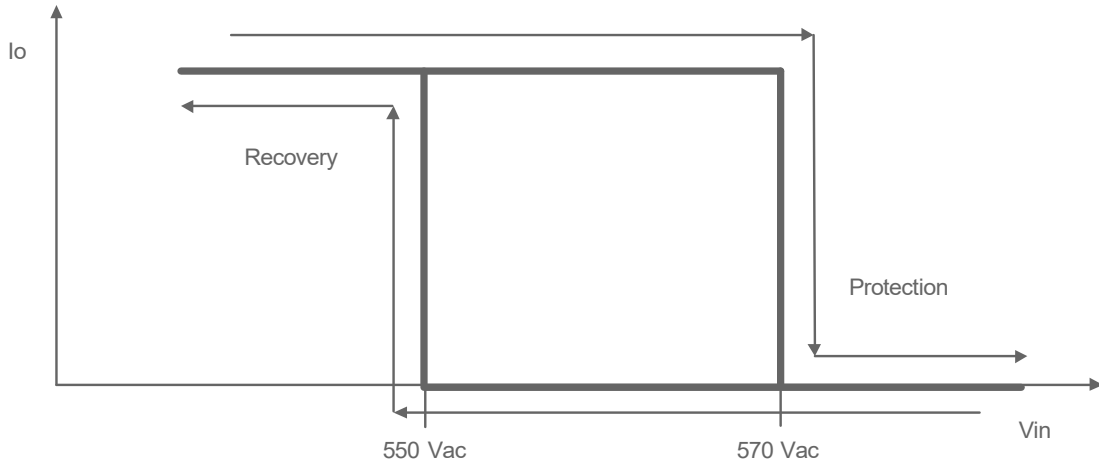

Dimming

● 0-10V Dimming

The recommended implementation of the dimming control is provided below.

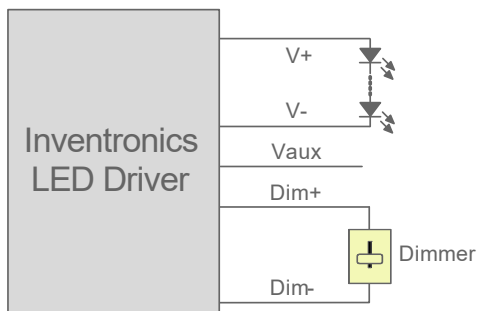

$I_o/I_{o\text{set}}$ vs. Dimming Voltage

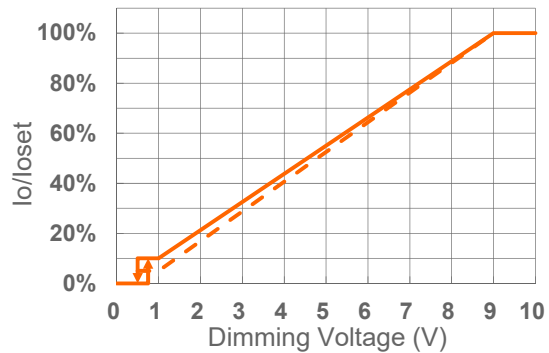

Implementation 1: Positive logic

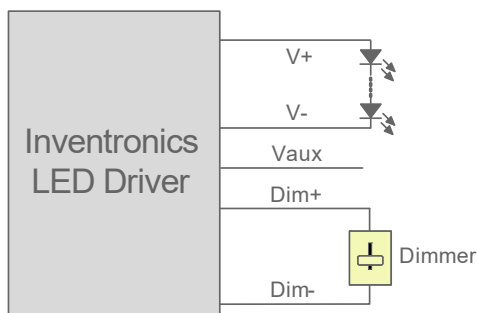

$I_o/I_{o\text{set}}$ vs. Dimming Voltage

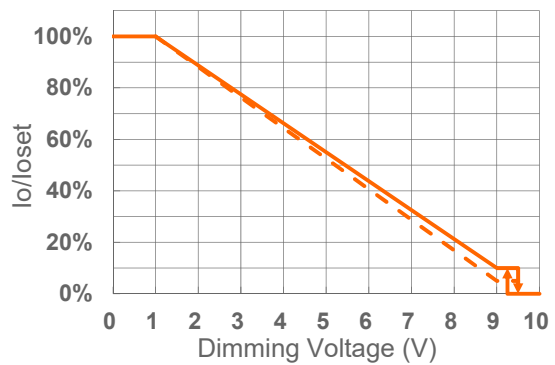

Implementation 2: Negative logic

Notes:

1. Do NOT connect Dim- to the output V- or V+, otherwise the driver will not work properly.
2. The dimmer can also be replaced by an active 0-10V voltage source signal or passive components like zener.
3. When 0-10V negative logic dimming mode and Dim+ is open, the driver will dim to off and be standby.

● **PWM Dimming**

The recommended implementation of the dimming control is provided below.

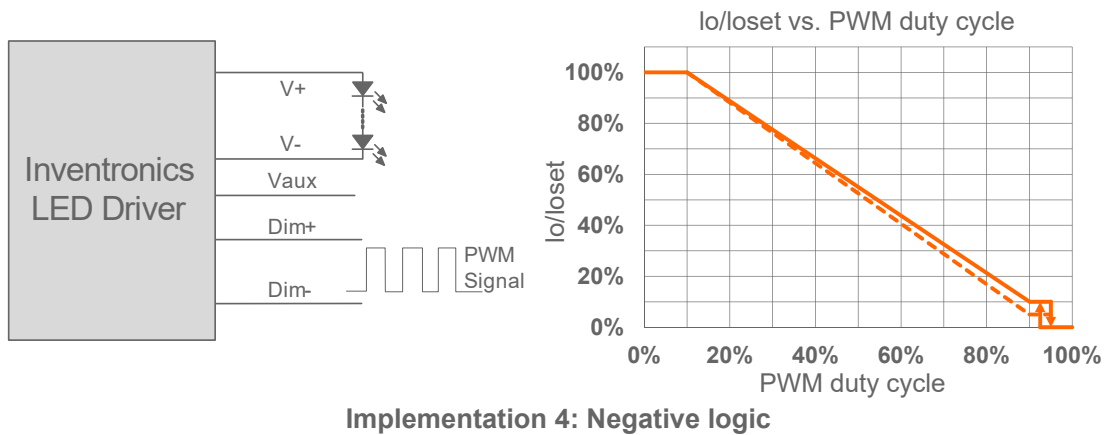
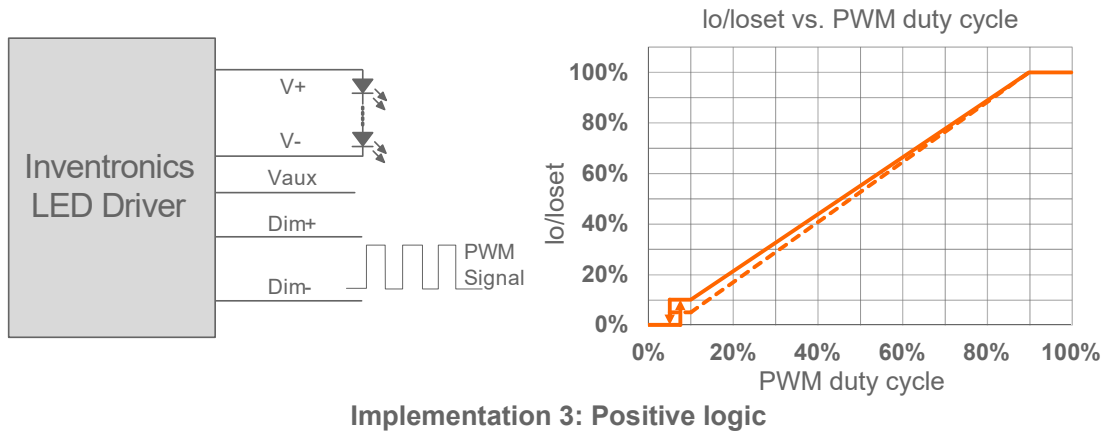

Notes:

1. Do NOT connect Dim- to the output V- or V+, otherwise the driver will not work properly.
2. When PWM negative logic dimming mode and Dim+ is open, the driver will dim to off and be standby.

● Resistor Dimming

The recommended implementation of the dimming control is provided below.

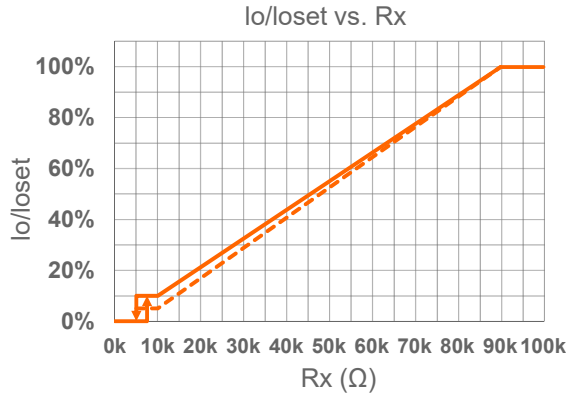
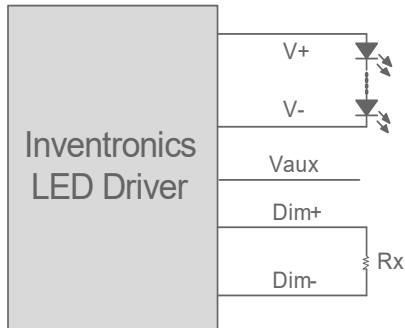

Implementation 5: Positive logic

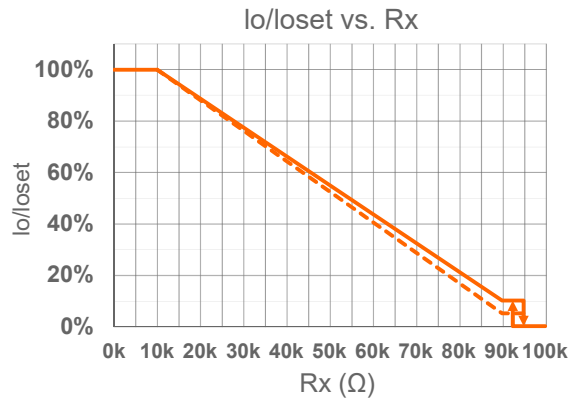
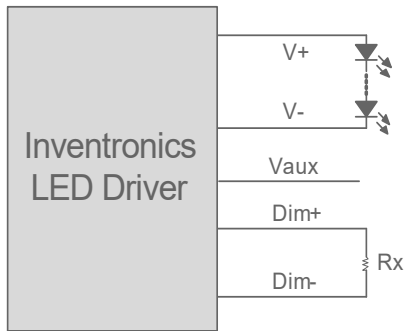

Implementation 6: Negative logic

Notes:

1. Do NOT connect Dim- to the output V- or V+, otherwise the driver will not work properly.
2. When resistor negative logic dimming mode and Dim+ is open, the driver will dim to off and be standby.

● Adjustable Dimming Curve

0-10V dimming curve can be set as corresponding dimming voltage by Inventronics Multi Programmer. Take the positive logic dimming as an example, the recommended implementation of the dimming control is provided below.

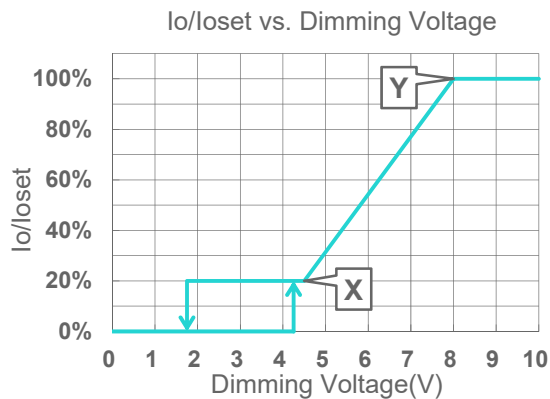
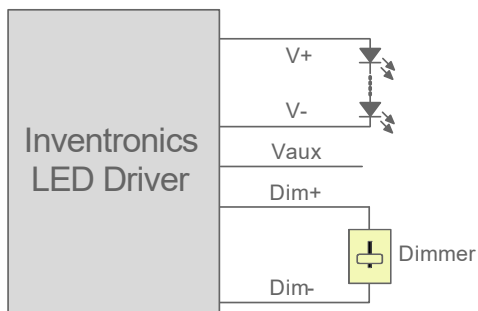

Implementation 7: Positive logic

13 / 17

Notes:

1. Do NOT connect Dim- to the output V- or V+, otherwise the driver will not work properly.
2. The dimmer can also be replaced by an active 0-10V voltage source signal or passive components like zener.
3. When dimming voltage X point is set to be smaller than Y point, the dimming curve is positive logic; conversely, when X point is set to be bigger than Y point, the dimming curve is negative logic.
4. For best dimming accuracy, the difference between X point and Y point is advised more than 4V.
5. Dimming off voltage adjustable.

● Time Dimming

Time dimming control includes 3 kinds of modes, they are Self Adapting-Midnight, Self Adapting-Percentage and Traditional Timer.

- **Self Adapting-Midnight:** Automatically adjusts the dimming curve based on the on-time of past two days (if difference <15 minutes), assuming that the center point of the dimming curve is midnight local time.
- **Self Adapting-Percentage:** Automatically adjusts the on-time of each step by a constant percentage = (actual on-time for the past 2 days if difference <15 min) / (programmed on-time from the dimming curve).
- **Traditional Timer:** Follows the programmed timing curve after power on with no changes.

● Output Lumen Compensation

Output Lumen Compensation (OLC) may be used to maintain constant light output over the life of the LEDs by driving them at a reduced current when new, then gradually increasing the drive current over time to counteract LED lumen degradation.

● Minimum Dimming Level with 5% or 10% Selectable

The minimum dimming level can be set as 5% or 10% by Inventronics Multi Programmer, 10% is default.

● Hold Time Adjustable

When AC power is first applied to the LED driver, enabling a "Hold" period can allow devices powered by the Auxiliary voltage to stabilize before the driver fades up to the maximum dimming level. During this period, the driver will not respond to external dimming commands but will respond again after the hold time ends. Both the initial dimming percentage and the duration of this hold period can be adjusted by the Inventronics Multi Programmer. This function is disabled by default.

● Fade Time Adjustable

There is a "Fade" period after the "Hold" period. The soft-start time and dimming slope applied to all dimming transitions can be adjusted individually. It is adjusted by the Inventronics Multi Programmer. This function is disabled by default.

● End Of Life

End-of-Life (EOL) is providing a visual notification to a user that the LED module has reached the end of manufacturer-specified life and that the replacement is recommended. Once active, an indication is given at each power-up of the driver, which the driver indicates this through a lower light output during the first 1 minute before normal operation is continued.

● Digital Dimming

Inventronics Digital Dimming is a UART (Universal Asynchronous Receive Transmitter) based communication protocol. Please refer to [Inventronics Digital Dimming](#) file for details.

Programming Connection Diagram

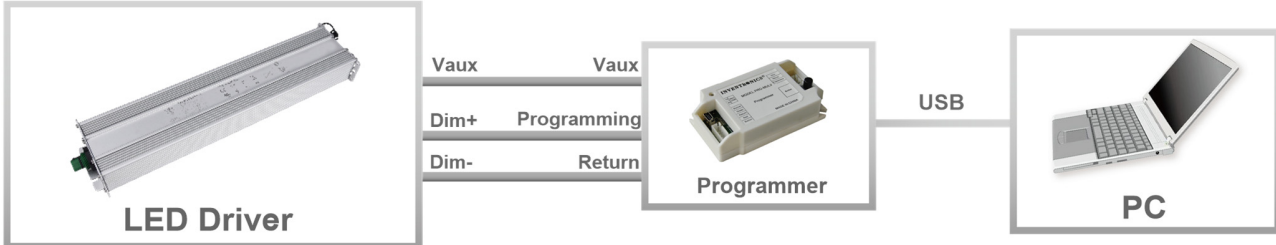

Note: The driver does not need to be powered on during the programming process.

- Please refer to [PRG-MUL2 \(Programmer\) datasheet](#) for details.

Mechanical Outline

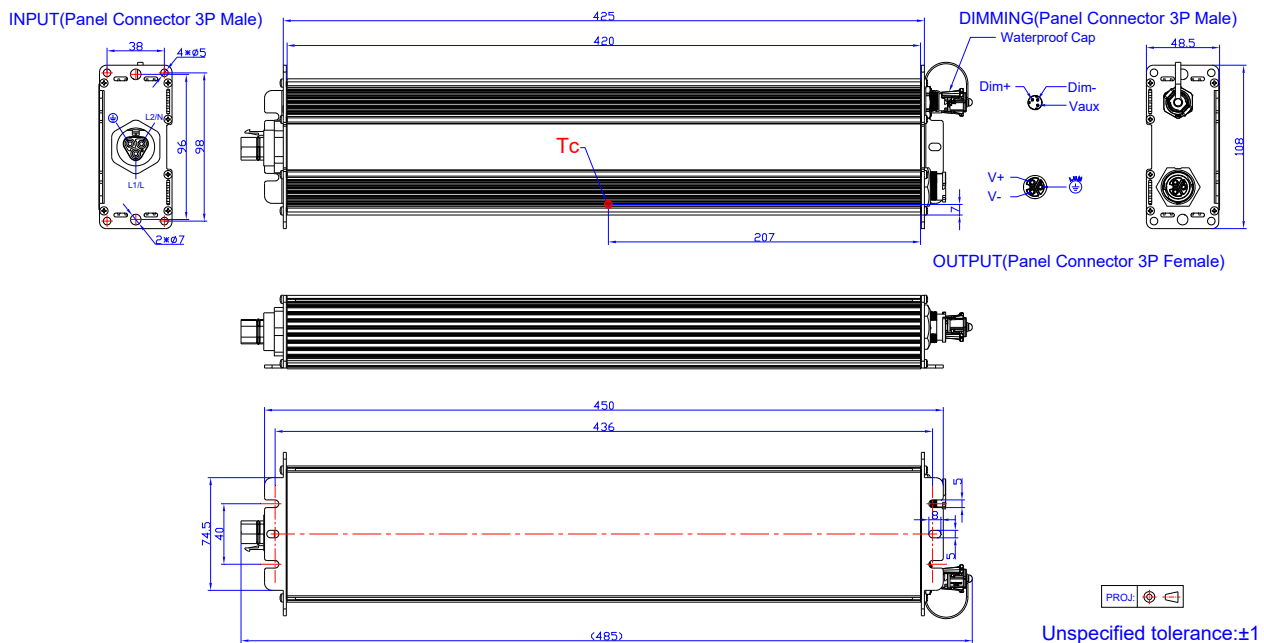

Note: This driver features UL Wet Location, IP67 panel mount connectors to streamline wiring in the field while still supporting stringent environmental conditions. The **mating** push-lock are not supplied by Inventronics. Please contact Wieland and Amphenol LTW or one of their suppliers for assistance sourcing the mating pushlock

Location	Series	Rating voltage/current	PN of connector on driver	PN of mating push-lock
Vin	Wieland RST20i3	600V/10A	96.032.1055.7	96.031.0055.7 (Spring) or 96.031.4055.7 (Screw)
Vo	ALTW X-Lok,C-Size	600V/10A	CC-03PMFS-QC801P	CC-03BFMB-QL8APA
		300V/20A	CC-03PMFS-QC800P	CC-03BFMB-QL8APP
Dim	ALTW X-Lok,A-Size	300V/5A	AD-03PMMS-QC8001	AD-03BFFB-QL8AP0
Dim	ALTW X-Lok,A-Size Waterproof Cap	/	CAP-WAAMQPC1	/

RoHS Compliance

Our products comply with reference to RoHS Directive (EU) 2015/863 amending 2011/65/EU, calling for the elimination of lead and other hazardous substances from electronic products.

Revision History

Change Date	Rev.	Description of Change		
		Item	From	To
2023-04-13	A	Datasheet Release	/	/
2023-12-29	B	Format	/	Updated
		Features	/	Updated
		Inrush Current Waveform	/	Updated
		Dimming	/	Updated