

Features

- Compact Metal Case with Excellent Thermal Performance
- Input Over Voltage Protection at 440Vac with 48 Hours
- Full Power at Wide Output Current Range (Constant Power)
- Adjustable Output Current (AOC) with Programmability
- Isolated 0-10V/10V PWM/3-Timer-Modes Dimmable
- Output Lumen Compensation
- Input Surge Protection: DM 4kV, CM 6kV
- All-Around Protection: IOVP, OVP, SCP, OTP
- IP66/IP67
- SELV Output
- 5 Years Warranty



Description

The EAM-200SxxxDB series is a 200W, constant-current, programmable and IP66/IP67 rated LED driver that operates from 90-305Vac input with excellent power factor. It is created for many lighting applications including high bay, high mast and roadway, etc. The high efficiency of these drivers and compact metal case enables them to run cooler, significantly improving reliability and extending product life. To ensure trouble-free operation, protection is provided against input surge, input over voltage, over voltage, short circuit, and over temperature.

Models

Adjustable Output Current Range	Full-Power Current Range (1)	Default Output Current	Input Voltage Range(2)	Output Voltage Range	Max. Output Power	Typical Efficiency (3)	Typical Power Factor		Model Number
							120Vac	220Vac	
70-1050mA	700-1050mA	700 mA	90~305 Vac/ 127~300 Vdc	95~286 Vdc	200 W	93.5%	0.99	0.96	EAM-200S105DB
105-1500mA	1050-1500mA	1050 mA	90~305 Vac/ 127~300 Vdc	67~190 Vdc	200 W	93.5%	0.99	0.96	EAM-200S150DB
180-2800mA	1800-2800mA	2100 mA	90~305 Vac/ 127~300 Vdc	36~111 Vdc	200 W	92.5%	0.99	0.96	EAM-200S280DB ⁽⁴⁾
350-5600mA	3500-5600mA	4200 mA	90~305 Vac/ 127~300 Vdc	18 ~ 57 Vdc	200 W	92.0%	0.99	0.96	EAM-200S560DB ⁽⁴⁾

- Notes:** (1) Output current range with constant power at 200W.
 (2) Certified input voltage range: 100-240/220-240/240Vac.
 (3) Measured at 100% load and 220Vac input (see below "General Specifications" for details).
 (4) SELV output.

I-V Operation Area

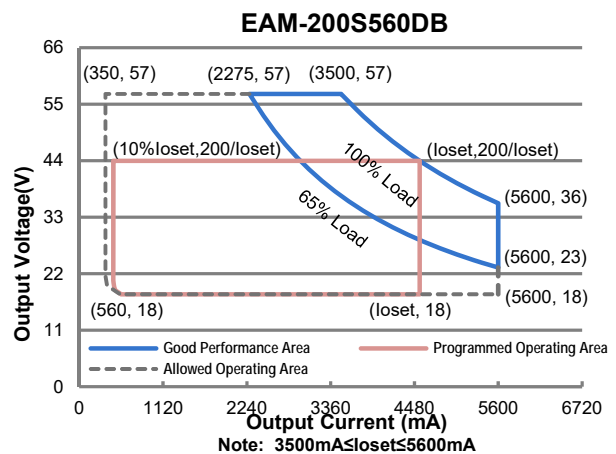
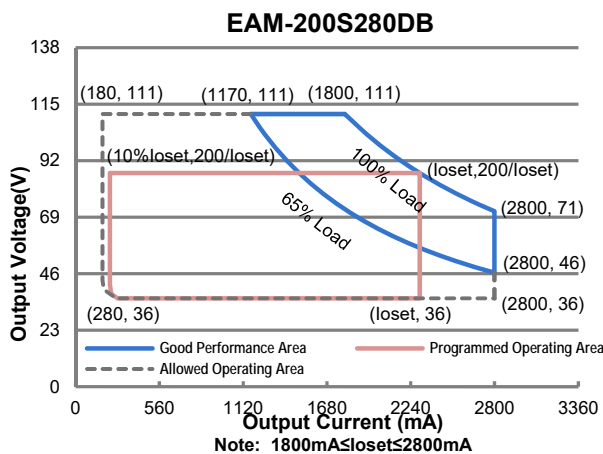
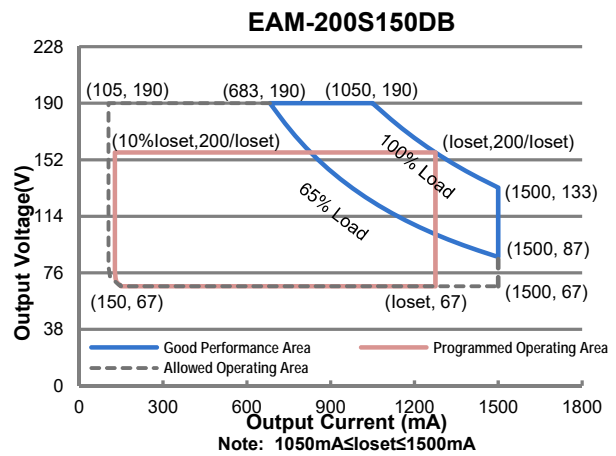
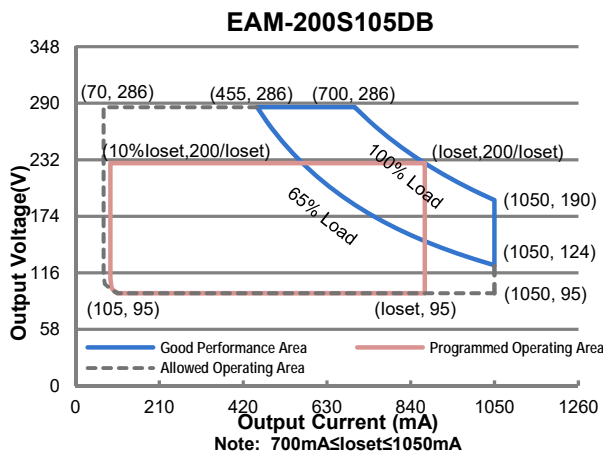

Input Specifications

Parameter	Min.	Typ.	Max.	Notes
Input AC Voltage	90 Vac	-	305 Vac	
Input DC Voltage	127 Vdc	-	300 Vdc	
Input Frequency	47 Hz	-	63 Hz	
Leakage Current	-	-	0.70 mA	IEC 60598-1; 240Vac/ 60Hz
Input AC Current	-	-	2.02 A	Measured at 100% load and 120 Vac input.
	-	-	1.09 A	Measured at 100% load and 220 Vac input.
Inrush Current(I ² t)	-	-	2.50 A ² s	At 220Vac input, 25°C cold start, duration=784 μs, 10%Ipk-10%Ipk. See Inrush Current Waveform for the details.
PF	0.9	-	-	At 100-277Vac, 50-60Hz, 65%-100% Load (130-200W)
THD	-	-	20%	
THD	-	-	10%	At 220-240Vac, 50-60Hz, 75%-100% Load (150-200W)

Output Specifications

Parameter	Min.	Typ.	Max.	Notes
Output Current Tolerance	-5%loset	-	5%loset	At 100% load condition
Output Current Setting(loset) Range				
EAM-200S105DB	70 mA	-	1050 mA	
EAM-200S150DB	105 mA	-	1500 mA	
EAM-200S280DB	180 mA	-	2800 mA	
EAM-200S560DB	350 mA	-	5600 mA	
Output Current Setting Range with Constant Power				
EAM-200S105DB	700 mA	-	1050 mA	
EAM-200S150DB	1050 mA	-	1500 mA	
EAM-200S280DB	1800 mA	-	2800 mA	
EAM-200S560DB	3500 mA	-	5600 mA	
Total Output Current Ripple (pk-pk)	-	5%Iomax	10%Iomax	At 100% load condition. 20 MHz BW
Output Current Ripple at < 200 Hz (pk-pk)	-	2%Iomax	-	At 100% load condition. Only this component of ripple is associated with visible flicker.
Startup Overshoot Current	-	-	10%Iomax	At 100% load condition
No Load Output Voltage				
EAM-200S105DB	-	-	320 V	
EAM-200S150DB	-	-	210 V	
EAM-200S280DB	-	-	120 V	
EAM-200S560DB	-	-	65 V	
Line Regulation	-	-	±0.5%	Measured at 100% load
Load Regulation	-	-	±1.5%	
Turn-on Delay Time	-	-	0.5 s	Measured at 120-277Vac input, 65%-100% Load
Temperature Coefficient of loset	-	0.03%/°C	-	Case temperature = 0°C ~Tc max

General Specifications

Parameter	Min.	Typ.	Max.	Notes
Efficiency at 120 Vac input:				
EAM-200S105DB				
I _o = 700 mA	89.0%	91.0%	-	
I _o =1050 mA	89.5%	91.5%	-	
EAM-200S150DB				
I _o =1050 mA	89.0%	91.0%	-	Measured at 100% load and steady-state temperature in 25°C ambient; (Efficiency will be about 2.0% lower if measured immediately after startup.)
I _o =1500 mA	89.0%	91.0%	-	
EAM-200S280DB				
I _o =1800 mA	88.0%	90.0%	-	
I _o =2800 mA	88.5%	90.5%	-	
EAM-200S560DB				
I _o =3500 mA	88.0%	90.0%	-	
I _o =5600 mA	88.0%	90.0%	-	

General Specifications (Continued)

Parameter	Min.	Typ.	Max.	Notes
Efficiency at 220 Vac input: EAM-200S105DB				Measured at 100% load and steady-state temperature in 25°C ambient; (Efficiency will be about 2.0% lower if measured immediately after startup.)
Io= 700 mA	91.5%	93.5%	-	
Io=1050 mA	91.5%	93.5%	-	
EAM-200S150DB				
Io=1050 mA	91.5%	93.5%	-	
Io=1500 mA	91.5%	93.5%	-	
EAM-200S280DB				
Io=1800 mA	90.5%	92.5%	-	
Io=2800 mA	90.5%	92.5%	-	
EAM-200S560DB				
Io=3500 mA	90.0%	92.0%	-	
Io=5600 mA	90.0%	92.0%	-	
Efficiency at 277 Vac input: EAM-200S105DB				Measured at 100% load and steady-state temperature in 25°C ambient; (Efficiency will be about 2.0% lower if measured immediately after startup.)
Io= 700 mA	91.5%	93.5%	-	
Io=1050 mA	92.0%	94.0%	-	
EAM-200S150DB				
Io=1050 mA	91.5%	93.5%	-	
Io=1500 mA	92.0%	94.0%	-	
EAM-200S280DB				
Io=1800 mA	91.0%	93.0%	-	
Io=2800 mA	91.0%	93.0%	-	
EAM-200S560DB				
Io=3500 mA	90.5%	92.5%	-	
Io=5600 mA	90.5%	92.5%	-	
MTBF	-	364,000 Hours	-	Measured at 220Vac input, 80%Load and 25°C ambient temperature (MIL-HDBK-217F)
Lifetime	-	106,000 Hours	-	Measured at 220Vac input, 80%Load and 70°C case temperature; See lifetime vs. Tc curve for the details
Operating Case Temperature for Safety Tc_s	-20°C	-	+90°C	
Operating Case Temperature for Warranty Tc_w	-20°C	-	+80°C	Case temperature for 5 years warranty Humidity: 10%RH to 95%RH
Storage Temperature	-20°C	-	+85°C	Humidity: 5%RH to 95%RH
Dimensions				With mounting ear
Inches (L × W × H)	6.73 × 2.36 × 1.44			7.40 × 2.36 × 1.44
Millimeters (L × W × H)	171 × 60 × 36.5			188 × 60 × 36.5
Net Weight	-	750 g	-	

Dimming Specifications

Parameter	Min.	Typ.	Max.	Notes
Absolute Maximum Voltage on the Vdim (+) Pin	-20 V	-	20 V	
Source Current on Vdim (+)Pin	200 µA	300 µA	450 µA	Vdim(+) = 0 V

Dimming Specifications (Continued)

Parameter		Min.	Typ.	Max.	Notes
Dimming Output Range	EAM-200S105DB EAM-200S150DB EAM-200S280DB EAM-200S560DB	10%loset	-	loset	700 mA ≤ loset ≤ 1050 mA 1050 mA ≤ loset ≤ 1500 mA 1800 mA ≤ loset ≤ 2800 mA 3500 mA ≤ loset ≤ 5600 mA
	EAM-200S105DB EAM-200S150DB EAM-200S280DB EAM-200S560DB	70 mA 105 mA 180 mA 350 mA	-	loset	70 mA ≤ loset < 700 mA 105 mA ≤ loset < 1050 mA 180 mA ≤ loset < 1800 mA 350 mA ≤ loset < 3500 mA
Recommended Dimming Range for 0-10V		1 V	-	9 V	Default 0-10V dimming mode with positive logic.
PWM_in High Level		-	10V	-	
PWM_in Low Level		-	0V	-	
PWM_in Frequency Range		200 Hz	-	2 KHz	
PWM_in Duty Cycle		0%	-	100%	

Safety & EMC Compliance

Safety Category	Standard
CE	EN 61347-1, EN 61347-2-13
BIS	IS 15885(Part2/Sec13)
EMI Standards	Notes
EN IEC 55015 (1)	Conducted emission Test & Radiated emission Test
EN IEC 61000-3-2	Harmonic current emissions
EN 61000-3-3	Voltage fluctuations & flicker
EMS Standards	Notes
EN 61000-4-2	Electrostatic Discharge (ESD): 8 kV air discharge, 4 kV contact discharge
EN 61000-4-3	Radio-Frequency Electromagnetic Field Susceptibility Test-RS
EN 61000-4-4	Electrical Fast Transient / Burst-EFT
EN 61000-4-5	Surge Immunity Test: AC Power Line: Differential Mode 4 kV, Common Mode 6 kV
EN 61000-4-6	Conducted Radio Frequency Disturbances Test-CS
EN 61000-4-8	Power Frequency Magnetic Field Test
EN 61000-4-11	Voltage Dips
EN 61547	Electromagnetic Immunity Requirements Applies To Lighting Equipment

Note: (1) This LED driver meets the EMI specifications above, but EMI performance of a luminaire that contains it depends also on the other devices connected to the driver and on the fixture itself.

Derating

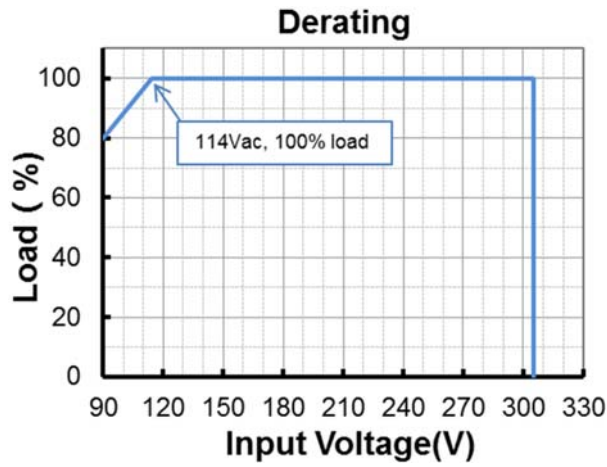

Lifetime vs. Case Temperature

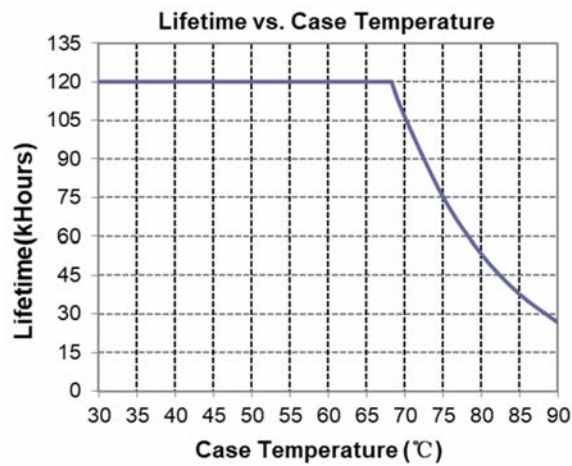

Inrush Current Waveform

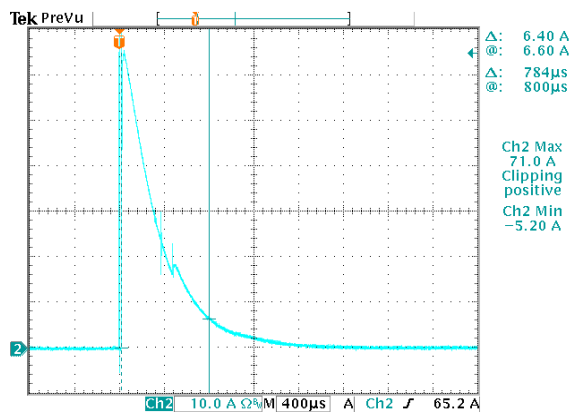

Efficiency vs. Load

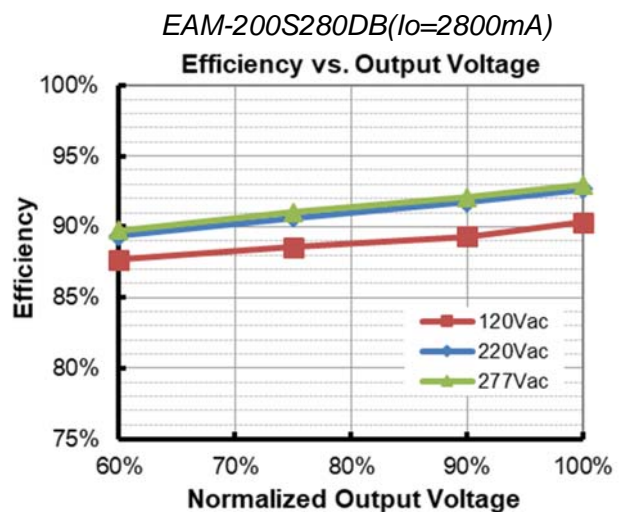
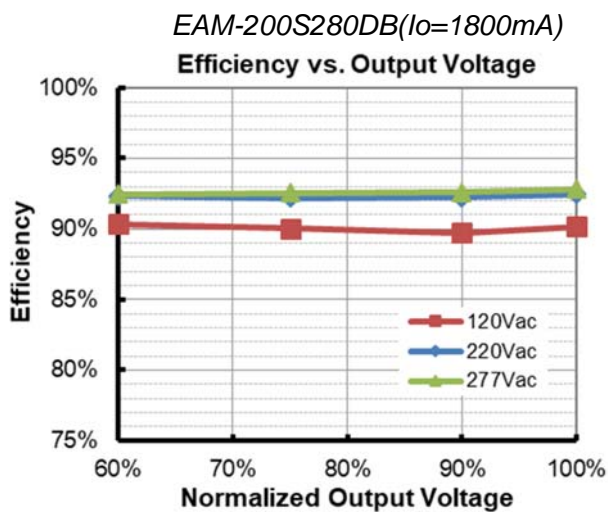
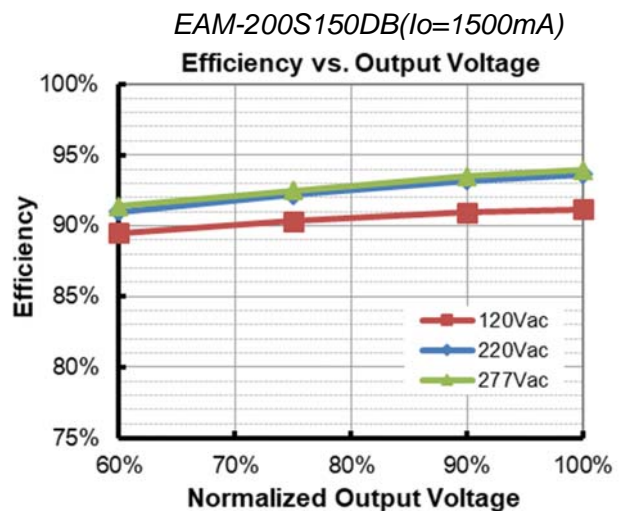
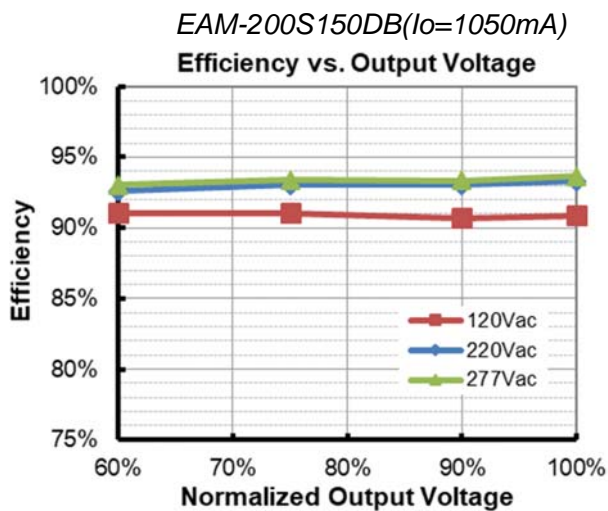
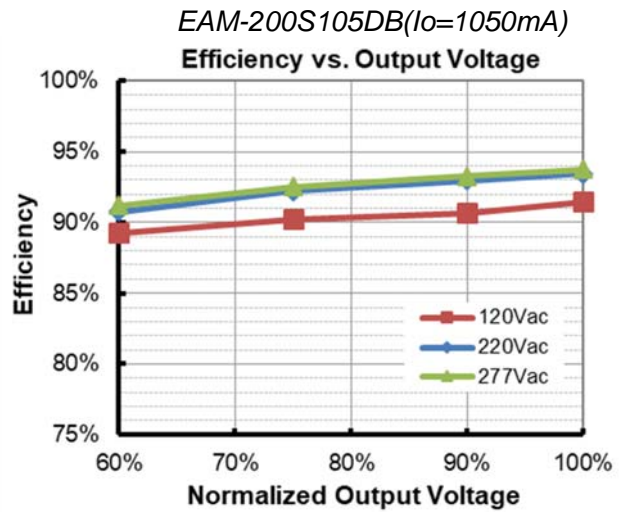
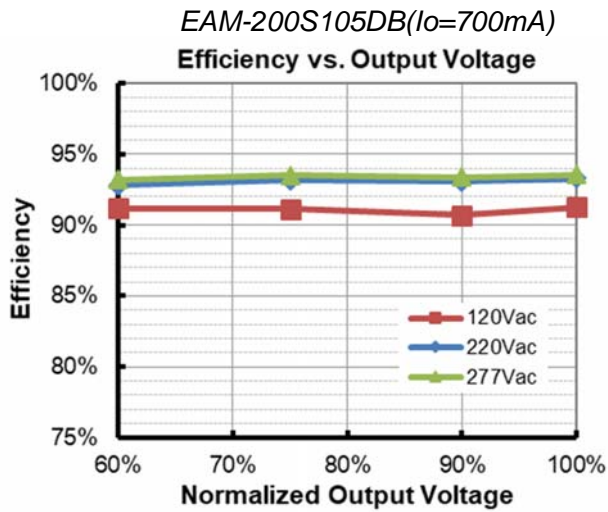

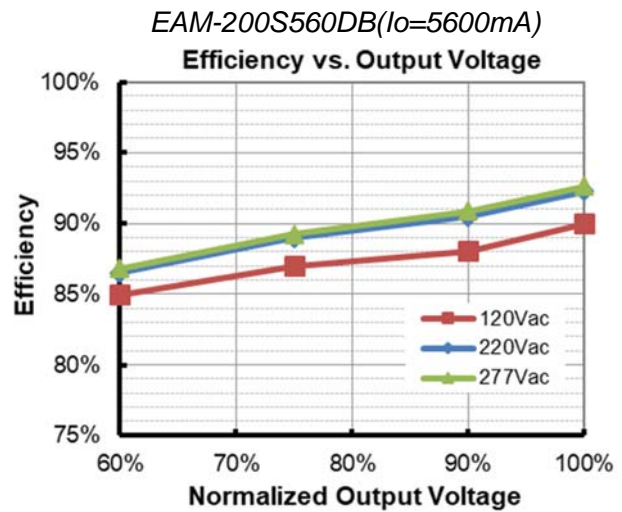
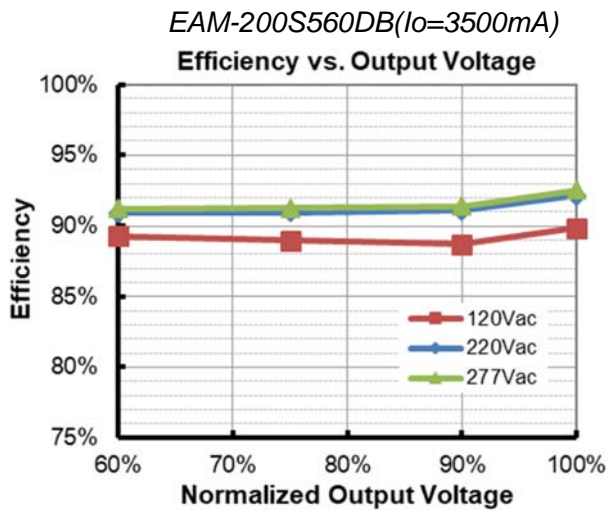

Power Factor

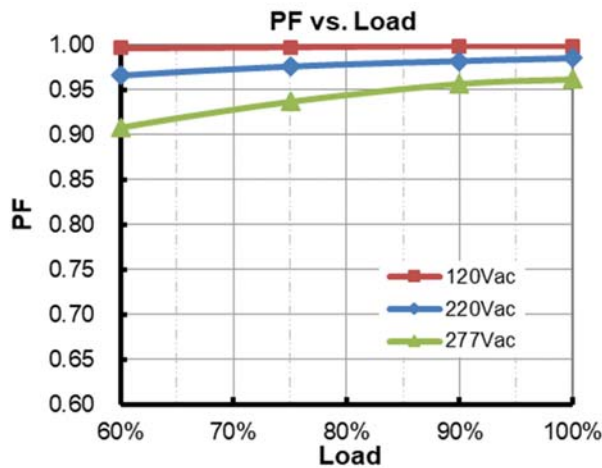

Total Harmonic Distortion

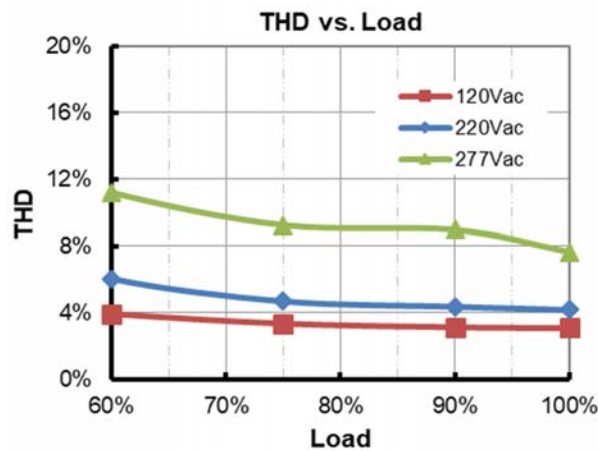

Protection Functions

Parameter		Min.	Typ.	Max.	Notes
Over Voltage Protection		Limits output voltage at no load and in case the normal voltage limit fails.			
Short Circuit Protection		Auto Recovery. No damage will occur when any output is short circuited. The output shall return to normal when the fault condition is removed.			
Over Temperature Protection		Decreases output current, returning to normal after over temperature is removed.			
Input Over Voltage Protection	Input Over Voltage Protection	320 Vac	340 Vac	360 Vac	Turn off the output when the input voltage exceeds protection voltage.
	Input Over Voltage Recovery	300 Vac	320 Vac	340 Vac	Auto Recovery. The driver will restart when the input voltage falls below recovery voltage.
	Max. of Input Over Voltage	-	-	440 Vac	The driver can survive for 48 hours with input voltage stress of 440Vac.

● Input Over Voltage Protection Diagram

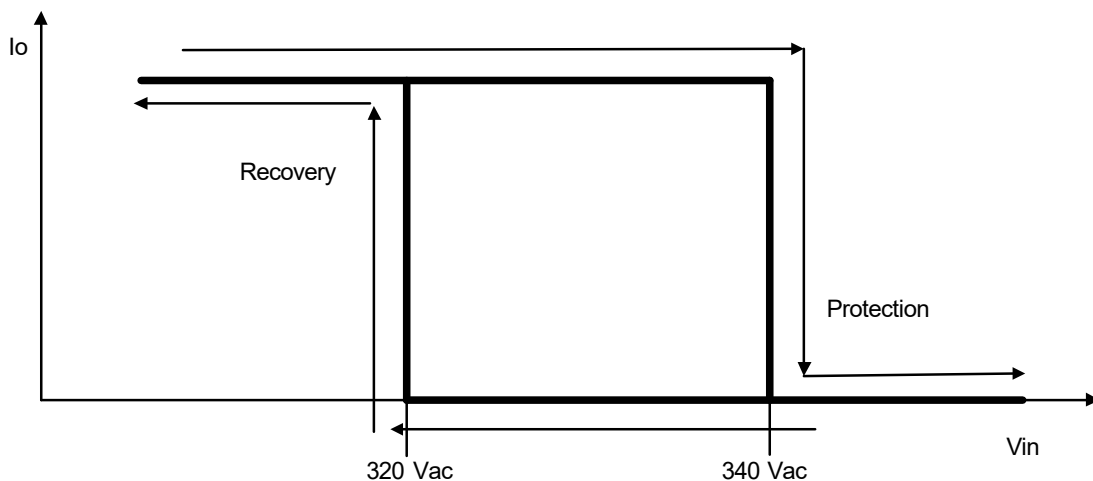

Dimming

● 0-10V Dimming

The recommended implementation of the dimming control is provided below.

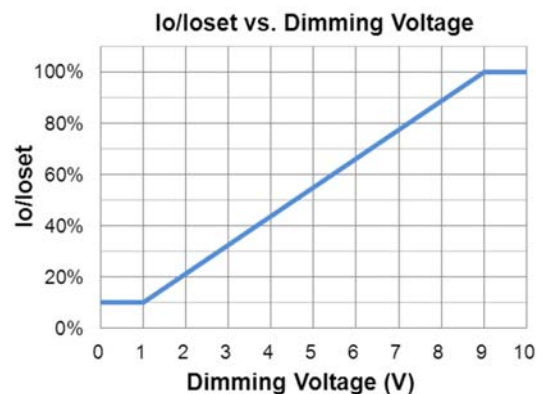
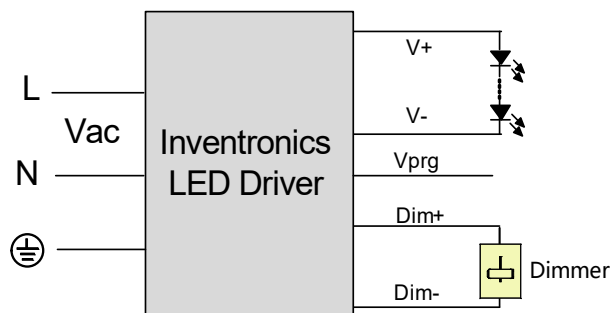

Implementation 3: Positive logic

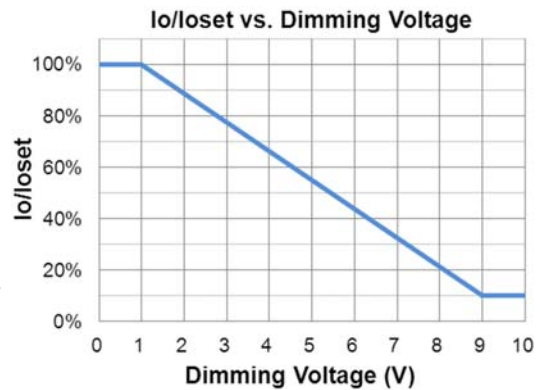
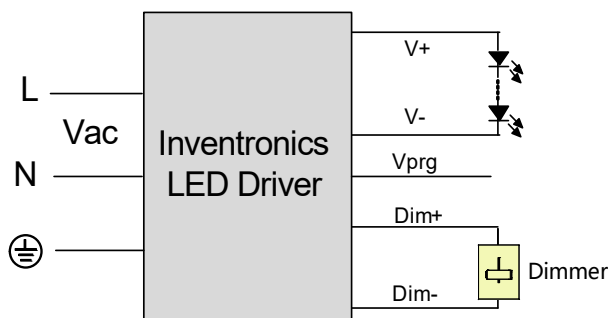

Implementation 4: Negative logic

Notes:

1. Do NOT connect Dim- to the output V- or V+, otherwise the driver will not work properly.
2. The dimmer can also be replaced by an active 0-10V voltage source signal or passive components like zener.
3. When 0-10V negative logic dimming mode and Dim+ is open, the driver will output minimum current.

● **10V PWM Dimming**

The recommended implementation of the dimming control is provided below.

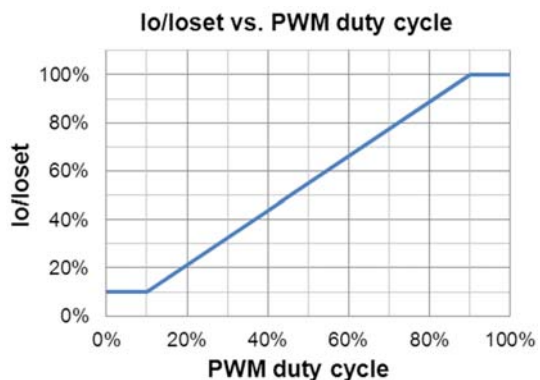
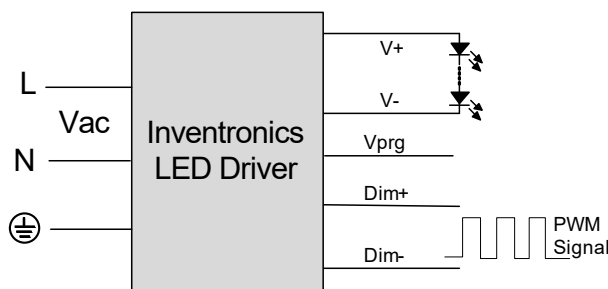

Implementation 5: Positive logic

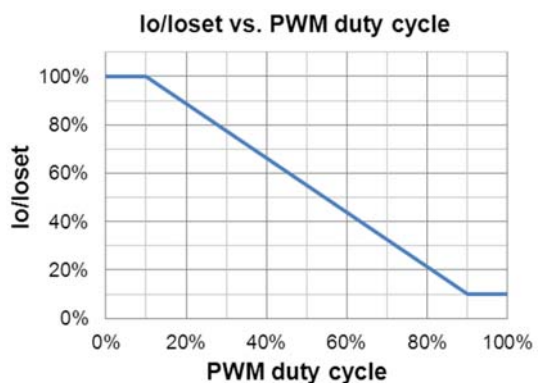
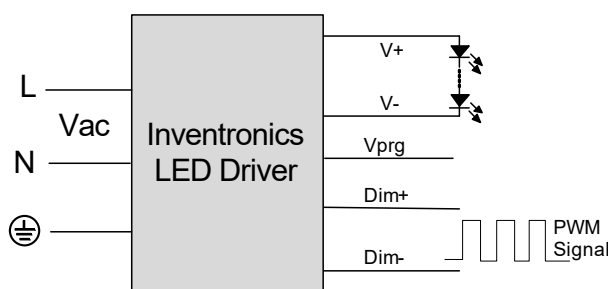

Implementation 6: Negative logic

Notes:

1. Do NOT connect Dim- to the output V- or V+, otherwise the driver will not work properly.
2. When 10V PWM negative logic dimming mode and Dim+ is open, the driver will output minimum current.

● Time Dimming

Time dimming control includes 3 kinds of modes, they are Self Adapting-Midnight, Self Adapting-Percentage and Traditional Timer.

- **Self Adapting-Midnight:** Automatically adjusts the dimming curve based on the on-time of past two days (if difference <15 minutes), assuming that the center point of the dimming curve is midnight local time.
- **Self Adapting-Percentage:** Automatically adjusts the on-time of each step by a constant percentage = (actual on-time for the past 2 days if difference <15 min) / (programmed on-time from the dimming curve).
- **Traditional Timer:** Follows the programmed timing curve after power on with no changes.

● Output Lumen Compensation

Output Lumen Compensation (OLC) may be used to maintain constant light output over the life of the LEDs by driving them at a reduced current when new, then gradually increasing the drive current over time to counteract LED lumen degradation.

Programming Connection Diagram

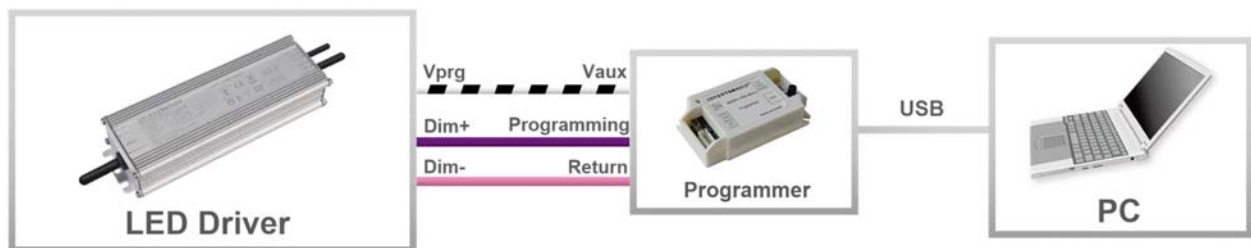

Note: The driver does not need to be powered on during the programming process.

- Please refer to [PRG-MUL2](#) (Programmer) datasheet for details.

Mechanical Outline

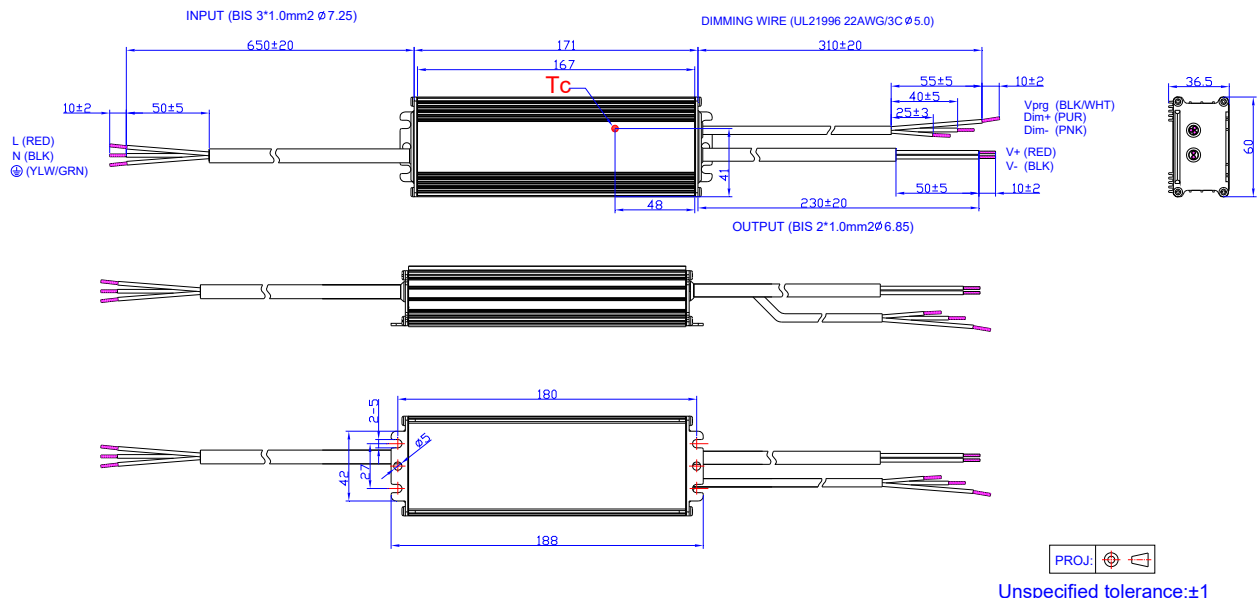

RoHS Compliance

Our products comply with reference to RoHS Directive (EU) 2015/863 amending 2011/65/EU, calling for the elimination of lead and other hazardous substances from electronic products.

Revision History

Change Date	Rev.	Description of Change		
		Item	From	To
2023-06-15	A	Datasheet Release	/	/