

Features

- Full Power at Wide Output Current Range (Constant Power)
- Adjustable Output Current (AOC) with NFC
- DALI-2 and D4i Certified
- 3-Timer-Modes Dimmable
- Dim-to-Off with Standby Power $\leq 0.5W$
- Dimming range: 5%-100%
- Always-on Auxiliary Power: 24Vdc, 125mA, 3W (Transient Peak Power up to 10W)
- Integrated 16Vdc Bus Power Supply based on DALI-2
- Integrated Power Monitoring with High Accuracy up to $\pm 1\%$
- Low Inrush Current
- Output Lumen Compensation
- End-of-Life Indicator
- Thermal Sensing and Protection for LED Module
- Input Surge Protection: DM 6kV, CM 10kV
- All-Around Protection: IUVP, IOVP, OVP, SCP, OTP
- IP66/IP67 and UL Dry/Damp/Wet Location
- TYPE HL, for use in a Class I, Division 2 Hazardous (Classified) Location
- 7 Years Warranty



Description

The EUM-480SxxxBG series is a 480W, constant-current, NFC programmable and IP66/IP67 rated LED driver that operates from 90-305Vac input with excellent power factor. Created for intra-luminaire solutions and health monitoring applications, this family provides integrated AC power monitoring with an auxiliary voltage and dim-to-off functionality for powering low voltage, wireless controls. The dimming control supports two-way communication via DALI-2 and complies with D4i. The high efficiency of these drivers and compact metal case enables them to run cooler, significantly improving reliability and extending product life. To ensure trouble-free operation, protection is provided against input surge, input under voltage, input over voltage, output over voltage, short circuit, and over temperature.

Models

Adjustable Output Current Range(A)	Full-Power Current Range(A) ⁽¹⁾	Default Output Current(A)	Output Voltage Range(Vdc)	Max. Output Power(W)	Typical Efficiency ⁽²⁾	Typical Power Factor		Model Number ⁽³⁾
						120Vac	220Vac	
0.105-1.4	1.05-1.4	1.4	171-457	480	95.0%	0.99	0.96	EUM-480S140BG
0.21-2.8	2.1-2.8	2.8	86-228	480	95.0%	0.99	0.96	EUM-480S280BG
0.315-4.2	3.15-4.2	4.2	57-152	480	94.0%	0.99	0.96	EUM-480S420BG
0.435-5.6	4.35-5.6	5.6	43-110	480	94.0%	0.99	0.96	EUM-480S560BG ⁽⁴⁾
0.86-10	8.6-10	10	24-56	480	94.0%	0.99	0.96	EUM-480S10ABG ⁽⁴⁾

- Notes:** (1) Output current range with constant power at 480W.
 (2) Measured at 100% load and 220Vac input (see below "General Specifications" for details).
 (3) Certified voltage range: UL, FCC 100-277Vac; otherwise 100-240Vac
 (4) SELV output.

I-V Operating Area

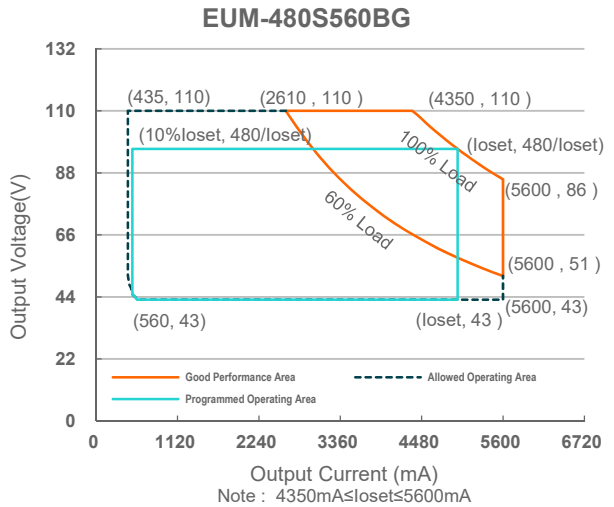
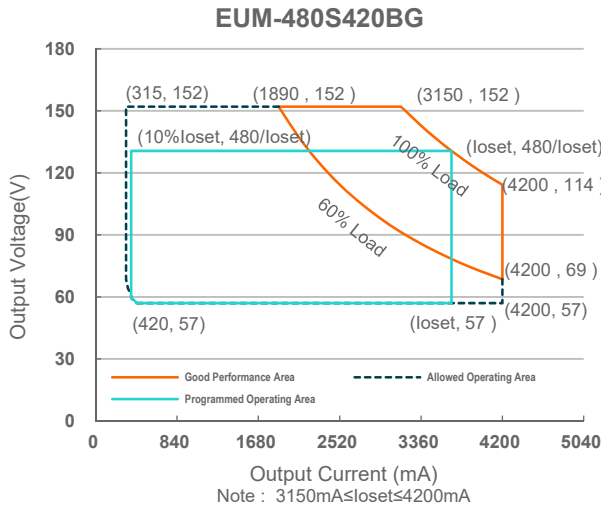
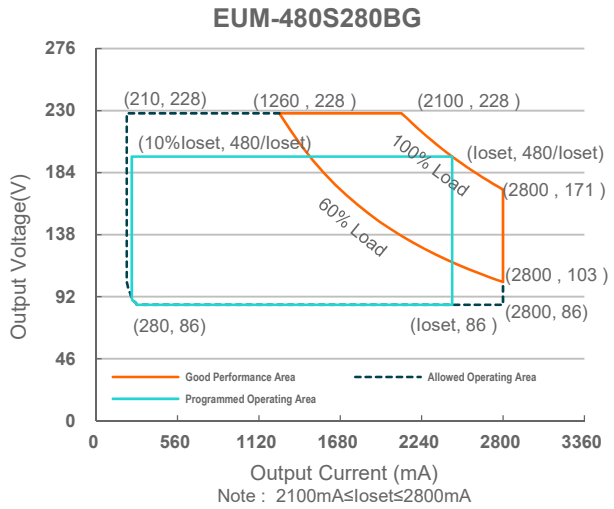
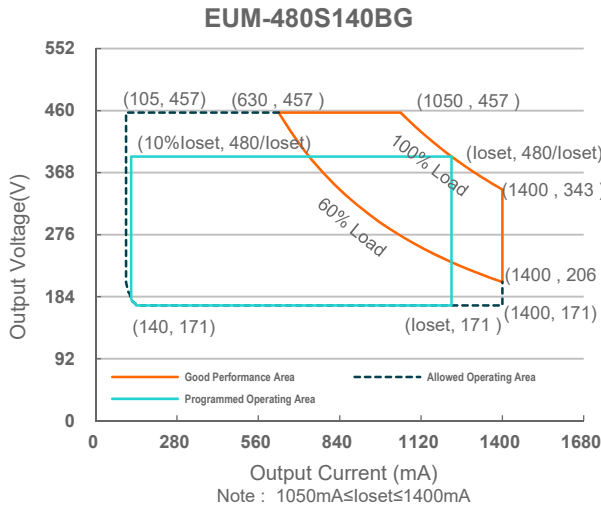

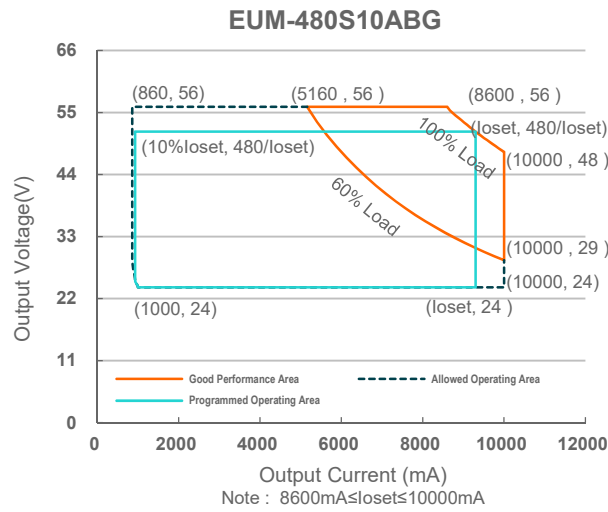

Input Specifications

Parameter	Min.	Typ.	Max.	Notes
Input AC Voltage	90 Vac	-	305 Vac	
Input DC Voltage	127 Vdc	-	250 Vdc	
Input Frequency	47 Hz	-	63 Hz	
Leakage Current	-	-	0.75 MIU	UL 8750; 277Vac/60Hz
	-	-	0.70 mA	IEC 60598-1; 240Vac/60Hz
Input AC Current	-	-	4.85 A	Measured at 100% load and 120 Vac input.
	-	-	2.61 A	Measured at 100% load and 220 Vac input.
Inrush Current(I ² t)	-	-	1.03 A ² s	At 220Vac input, 25°C cold start, duration=6.52ms, 10%I _{pk} -10%I _{pk} .
PF	0.90	-	-	At 100-277Vac,50-60Hz,60%-100% Load (288- 480W)
THD	-	-	20%	
THD			10%	At 220-240Vac,50-60Hz,75%-100% Load (360-480W)

Output Specifications

Parameter	Min.	Typ.	Max.	Notes
Output Current Tolerance	-5%loset	-	5%loset	100% load
Output Current Setting(loset) Range				
EUM-480S140BG	105 mA	-	1400 mA	
EUM-480S280BG	210 mA	-	2800 mA	
EUM-480S420BG	315 mA	-	4200 mA	
EUM-480S560BG	435 mA	-	5600 mA	
EUM-480S10ABG	860 mA	-	10000 mA	

Output Specifications (Continued)

Parameter	Min.	Typ.	Max.	Notes
Output Current Setting Range with Constant Power				
EUM-480S140BG	1050 mA	-	1400 mA	
EUM-480S280BG	2100 mA	-	2800 mA	
EUM-480S420BG	3150 mA	-	4200 mA	
EUM-480S560BG	4350 mA	-	5600 mA	
EUM-480S10ABG	8600 mA	-	10000 mA	
Total Output Current Ripple (pk-pk)	-	5%Iomax	10%Iomax	100% load, 20 MHz BW
Output Current Ripple at < 200 Hz (pk-pk)	-	2%Iomax	-	100% load
Startup Overshoot Current	-	-	10%Iomax	100% load
No Load Output Voltage				
EUM-480S140BG	-	-	500 V	
EUM-480S280BG	-	-	280 V	
EUM-480S420BG	-	-	190 V	
EUM-480S560BG	-	-	120 V	
EUM-480S10ABG	-	-	60 V	
Line Regulation	-	-	±0.5%	100% load
Load Regulation	-	-	±1.5%	
Turn-on Delay Time	-	-	0.5 s	Measured at all dimming modes except DALI-2, and 120-277Vac input, 60%-100% Load
			1.0 s	Measured at DALI-2 dimming mode, and 120-277Vac input, 60%-100% Load
Temperature Coefficient of I _{oset}	-	0.03%/°C	-	Case temperature = 0°C ~T _c max
24V Auxiliary Output Voltage	21.6 V	24 V	26.4 V	
24V Auxiliary Output Source Current	0 mA	-	125 mA	Return terminal is "DA"
24V Auxiliary Output Transient Peak Current@6W	-	-	250 mA	250mA peak for a maximum duration of 2.2ms in a 6.0ms period during which time the average should not exceed 125mA.
24V Auxiliary Output Transient Peak Current@10W	-	-	425 mA	425mA peak for a maximum duration of 1.3ms in a 5.2ms period during which time the average should not exceed 125mA.
Integrated DALI-2 Bus Power Supply Voltage	12 Vdc	16 Vdc	20 Vdc	Voltage is depending on loading.
Integrated DALI-2 Bus Power Maximum Supply Current	60 mA			
Integrated DALI-2 Bus Power Guaranteed Supply Current	50 mA			DALI-2 Bus Power Supply Voltage ≥12V

Notes: (1) DALI-2 bus power supply is enabled by default and can be disabled via programming interface.
(2) DALI-2 bus power supply supports automatic shut-down and restart after short-circuit.

General Specifications

Parameter	Min.	Typ.	Max.	Notes	
Efficiency at 120 Vac input: EUM-480S140BG					
Io= 1050 mA	91.5%	93.5%	-		
Io= 1400 mA	91.5%	93.5%	-		
EUM-480S280BG					
Io= 2100 mA	91.5%	93.5%	-		
Io= 2800 mA	91.5%	93.5%	-		
EUM-480S420BG					
Io= 3150 mA	90.0%	92.0%	-	Measured at 100% load and steady-state temperature in 25°C ambient; (Efficiency will be about 2.0% lower if measured immediately after startup.)	
Io= 4200 mA	90.0%	92.0%	-		
EUM-480S560BG					
Io= 4350 mA	90.5%	92.5%	-		
Io= 5600 mA	90.5%	92.5%	-		
EUM-480S10ABG					
Io= 8600 mA	90.5%	92.5%	-		
Io= 10000 mA	90.5%	92.5%	-		
Efficiency at 220 Vac input: EUM-480S140BG					
Io= 1050 mA	93.0%	95.0%	-		
Io= 1400 mA	93.0%	95.0%	-		
EUM-480S280BG					
Io= 2100 mA	93.0%	95.0%	-	Measured at 100% load and steady-state temperature in 25°C ambient; (Efficiency will be about 2.0% lower if measured immediately after startup.)	
Io= 2800 mA	93.0%	95.0%	-		
EUM-480S420BG					
Io= 3150 mA	92.0%	94.0%	-		
Io= 4200 mA	92.0%	94.0%	-		
EUM-480S560BG					
Io= 4350 mA	91.5%	93.5%	-		
Io= 5600 mA	92.0%	94.0%	-		
EUM-480S10ABG					
Io= 8600 mA	92.0%	94.0%	-		
Io= 10000 mA	92.0%	94.0%	-		
Efficiency at 277 Vac input: EUM-480S140BG					
Io= 1050 mA	93.0%	95.0%	-		
Io= 1400 mA	93.0%	95.0%	-		
EUM-480S280BG					
Io= 2100 mA	93.0%	95.0%	-	Measured at 100% load and steady-state temperature in 25°C ambient; (Efficiency will be about 2.0% lower if measured immediately after startup.)	
Io= 2800 mA	93.0%	95.0%	-		
EUM-480S420BG					
Io= 3150 mA	92.5%	94.5%	-		
Io= 4200 mA	92.0%	94.0%	-		
EUM-480S560BG					
Io= 4350 mA	92.0%	94.0%	-		
Io= 5600 mA	92.0%	94.0%	-		
EUM-480S10ABG					
Io= 8600 mA	92.0%	94.0%	-		
Io= 10000 mA	92.0%	94.0%	-		
Power Monitoring Accuracy	-1%	-	1%		Measured at 220Vac input and 100% Load
Standby Power	-	-	0.5 W	Measured at 230Vac/50Hz; Dimming off	
MTBF	-	293,000 Hours	-	Measured at 220Vac input, 80%Load and 25°C ambient temperature (MIL-HDBK-217F)	

General Specifications (Continued)

Parameter	Min.	Typ.	Max.	Notes
Lifetime	-	110,000 Hours	-	Measured at 220Vac input, 80%Load and 70°C case temperature; See lifetime vs. Tc curve for the details
	-	86,000 Hours	-	Measured at 220Vac input, 100%Load and 40°C ambient temperature
Operating Case Temperature for Safety Tc_s	-40°C	-	+90°C	
Operating Case Temperature for Warranty Tc_w	-40°C	-	+75°C	Case temperature for 7 years warranty Humidity: 10%RH to 95%RH
Storage Temperature	-40°C	-	+85°C	Humidity: 5%RH to 95%RH
Dimensions Inches (L × W × H) Millimeters (L × W × H)	9.57 × 3.54 × 1.71 243 × 90 × 43.5			With mounting ear 10.31 × 3.54 × 1.71 262 × 90 × 43.5
Net Weight	-	1870 g	-	

Dimming Specifications

Parameter	Min.	Typ.	Max.	Notes	
DA+, DA- High Level	9.5 V	16 V	22.5 V		
DA+, DA- Low Level	-6.5 V	0 V	6.5 V		
DA+, DA- Current	0 mA	-	2 mA		
Dimming Output Range with 5%-100%	EUM-480S140BG EUM-480S280BG EUM-480S420BG EUM-480S560BG EUM-480S10ABG	5%loset	-	loset	1050 mA ≤ loiset ≤ 1400 mA 2100 mA ≤ loiset ≤ 2800 mA 3150 mA ≤ loiset ≤ 4200 mA 4350 mA ≤ loiset ≤ 5600 mA 8600 mA ≤ loiset ≤ 10000 mA
	EUM-480S140BG EUM-480S280BG EUM-480S420BG EUM-480S560BG EUM-480S10ABG	53 mA 105 mA 158 mA 218 mA 430 mA	-	loset	105 mA ≤ loiset < 1050 mA 210 mA ≤ loiset < 2100 mA 315mA ≤ loiset < 3150 mA 435mA ≤ loiset < 4350 mA 860mA ≤ loiset < 8600 mA

Safety & EMC Compliance

Safety Category	Standard
UL/CUL	UL 8750,CAN/CSA-C22.2 No. 250.13
ENEC	EN 61347-1, EN 61347-2-13
UKCA	BS EN 61347-1, BS EN 61347-2-13 BS EN 301 489-1 BS EN 301 489-3 BS EN 300 330 BS EN 62479/BS EN 50663/BS EN 50665/BS EN 50364
CE	EN 61347-1, EN 61347-2-13 EN 301 489-1 EN 301 489-3 EN 300 330 EN 62479/EN 50663/EN 50665/EN 50364

Safety & EMC Compliance (Continued)

Safety Category	Standard
CB	IEC 61347-1, IEC 61347-2-13
CCC	GB 19510.1, GB 19510.14
KC	KC 61347-1, KC 61347-2-13
EAC	TP TC 004, TP TC 020
global-mark	AS/NZS 61347.1, AS/NZS 61347.2.13
Performance	Standard
ENEC	EN 62384
EMI Standards	Notes
BS EN/EN IEC 55015/GB/T 17743/KS C 9815 ⁽¹⁾	Conducted emission Test & Radiated emission Test
BS EN/EN IEC 61000-3-2/GB 17625.1	Harmonic current emissions
BS EN/EN 61000-3-3	Voltage fluctuations & flicker
FCC Part 15 ⁽¹⁾	ANSI C63.4 Class B
	This device complies with Part 15 of the FCC Rules. Operation is subject to the following two conditions: [1] this device may not cause harmful interference, and [2] this device must accept any interference received, including interference that may cause undesired Operation.
EMS Standards	Notes
BS EN/EN 61000-4-2	Electrostatic Discharge (ESD): 8 kV air discharge, 4 kV contact discharge
BS EN/EN 61000-4-3	Radio-Frequency Electromagnetic Field Susceptibility Test-RS
BS EN/EN 61000-4-4	Electrical Fast Transient / Burst-EFT
BS EN/EN 61000-4-5	Surge Immunity Test: AC Power Line: Differential Mode 6 kV, Common Mode 10 kV
BS EN/EN 61000-4-6	Conducted Radio Frequency Disturbances Test-CS
BS EN/EN 61000-4-8	Power Frequency Magnetic Field Test
BS EN/EN 61000-4-11	Voltage Dips
BS EN/EN 61547/KS C 9547	Electromagnetic Immunity Requirements Applies To Lighting Equipment
DALI-2 Standards	Notes
DALI-2 ⁽²⁾	IEC 62386-101, -102 & -207

Notes: (1) This LED driver meets the EMI specifications above, but EMI performance of a luminaire that contains it depends also on the other devices connected to the driver and on the fixture itself.

(2) DALI parts: 101, 102, 150, 207, 250, 251, 252, 253.

Derating

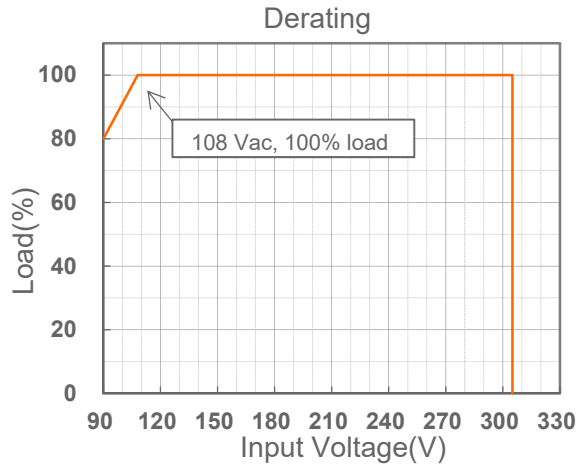

Lifetime vs. Case Temperature

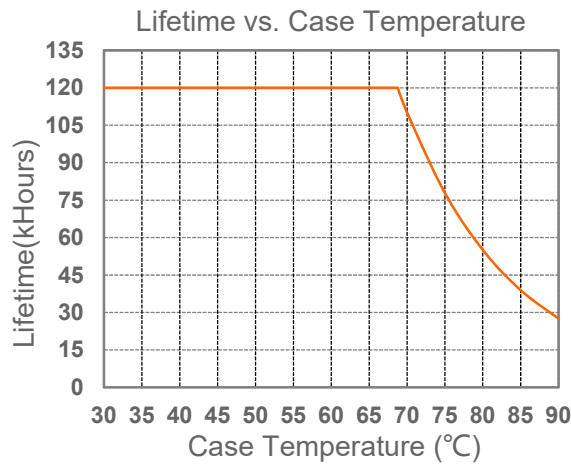

Inrush Current Waveform

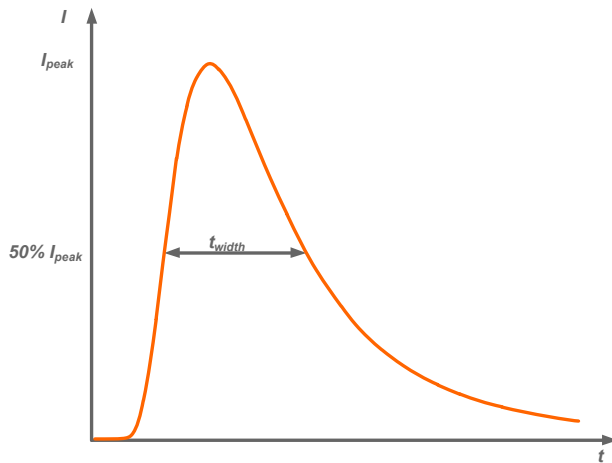

Input AC Voltage	I_{peak}	t_{width} (@ 50% I_{peak})
220V	14.5A	2.0ms

Efficiency vs. Load

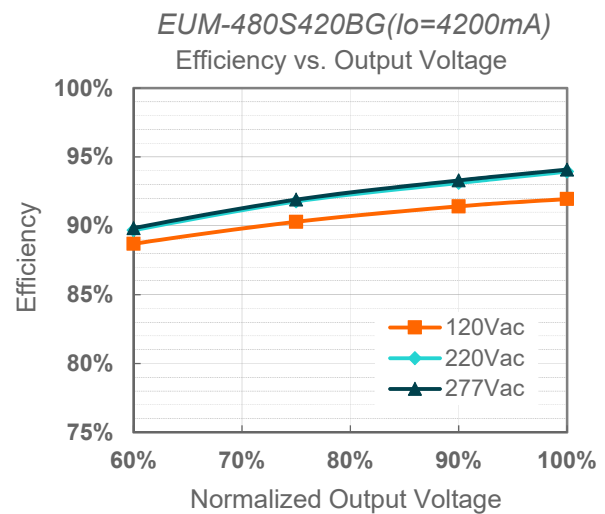
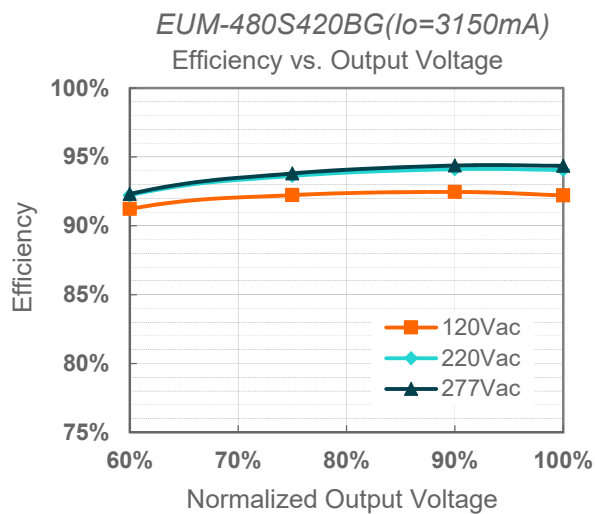
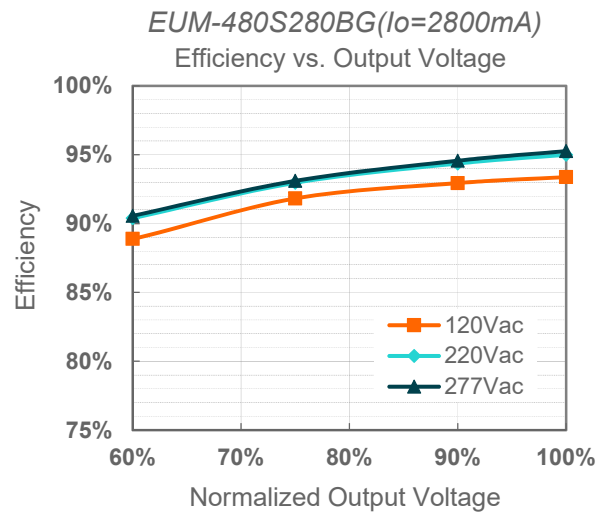
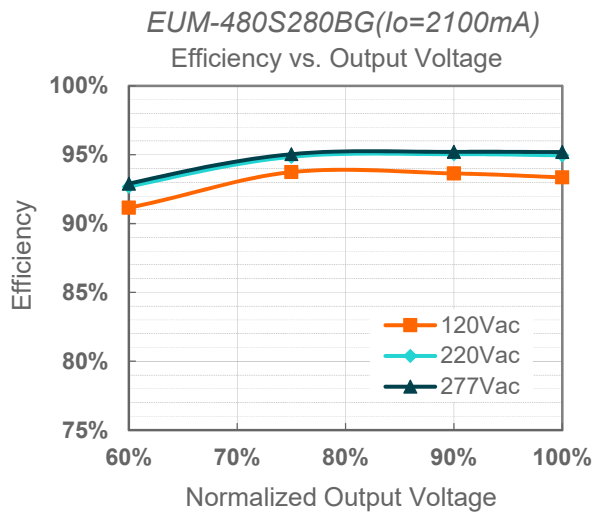
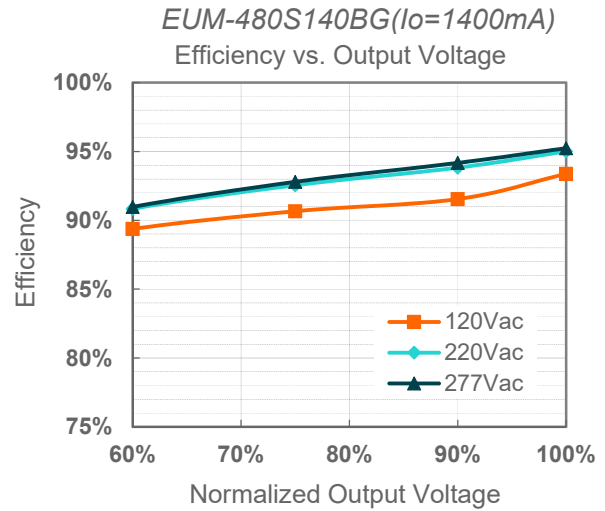
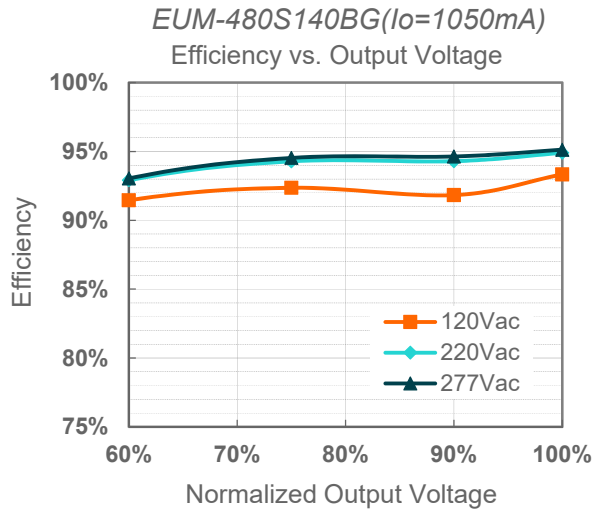

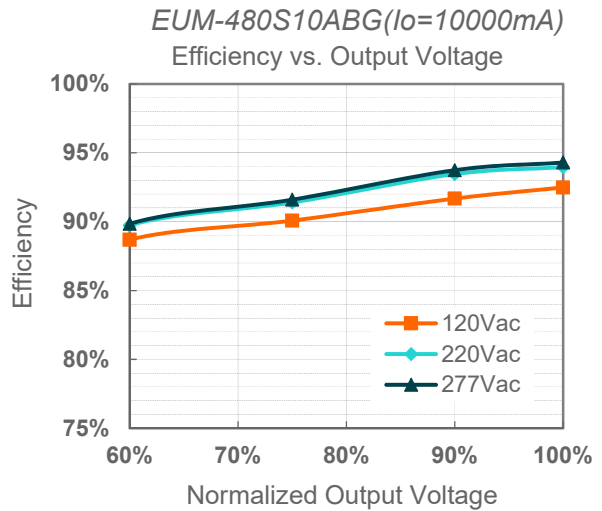
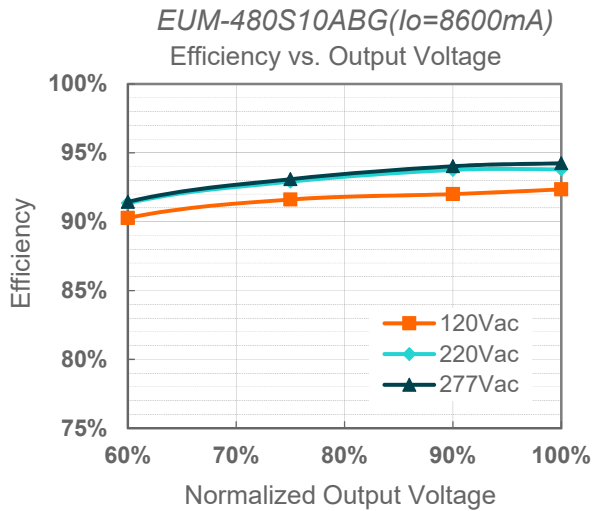
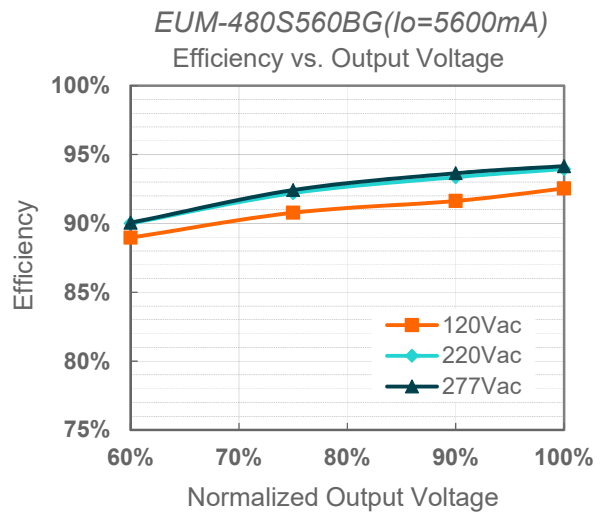
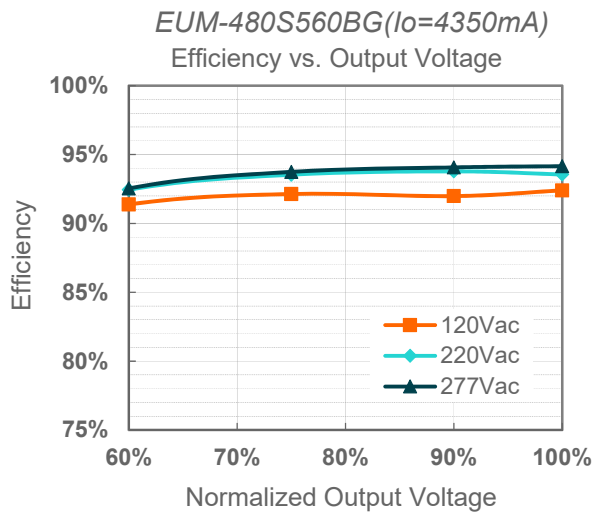

Power Factor

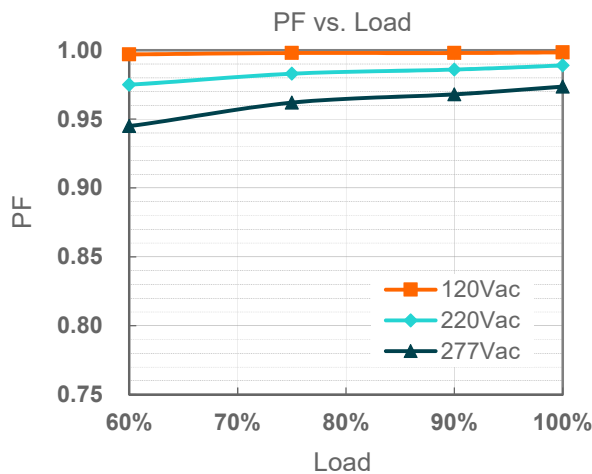

Total Harmonic Distortion

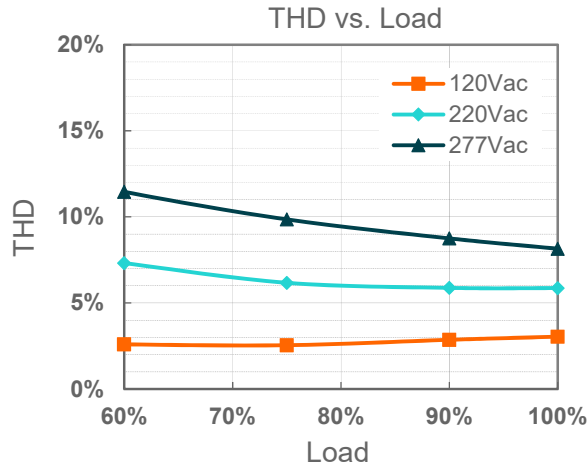

Protection Functions

Parameter		Min.	Typ.	Max.	Notes
External Thermal Protection	R1 (Start derating)	-	1.67 kΩ	-	The output current starts to decrease linearly when the actual NTC resistance value is lower than R1, until R2 is reached.
	R2 (Stop derating)	-	1.27 kΩ	-	When the actual NTC resistance value is lower than R2, the output current will stay at the programmed Protection Current Floor.
	Protection Current Setting Range	10%loset Iomin	20%loset	100%loset	10%loset > Iomin (default setting is 20%) 10%loset ≤ Iomin (default setting is 20%)
Over Temperature Protection		Decreases output current, returning to normal after over temperature is removed.			
Short Circuit Protection		Auto Recovery. No damage will occur when any output is short circuited. The output shall return to normal when the fault condition is removed.			
Over Voltage Protection		Limits output voltage at no load and in case the normal voltage limit fails.			
Input Under Voltage Protection (IUVP)	Input Protection Voltage	70 Vac	80 Vac	90 Vac	Turn off the output when the input voltage falls below protection voltage.
	Input Recovery Voltage	75 Vac	85 Vac	95 Vac	Auto Recovery. The driver will restart when the input voltage exceeds recovery voltage.
Input Over Voltage Protection (IOVP)	Input Over Voltage Protection	310 Vac	320 Vac	330 Vac	Turn off the output when the input voltage exceeds protection voltage.
	Input Over Voltage Recovery	300 Vac	310 Vac	320 Vac	Auto Recovery. The driver will restart when the input voltage falls below recovery voltage.
	Max. of Input Over Voltage	-	-	350 Vac	The driver can survive for 8 hours with a stable input voltage stress of 350Vac.

Note: (1) The recommended NTC type is 10kΩ NTC, Murata NCP18XH103J03RB.

● Input Under Voltage Protection Diagram

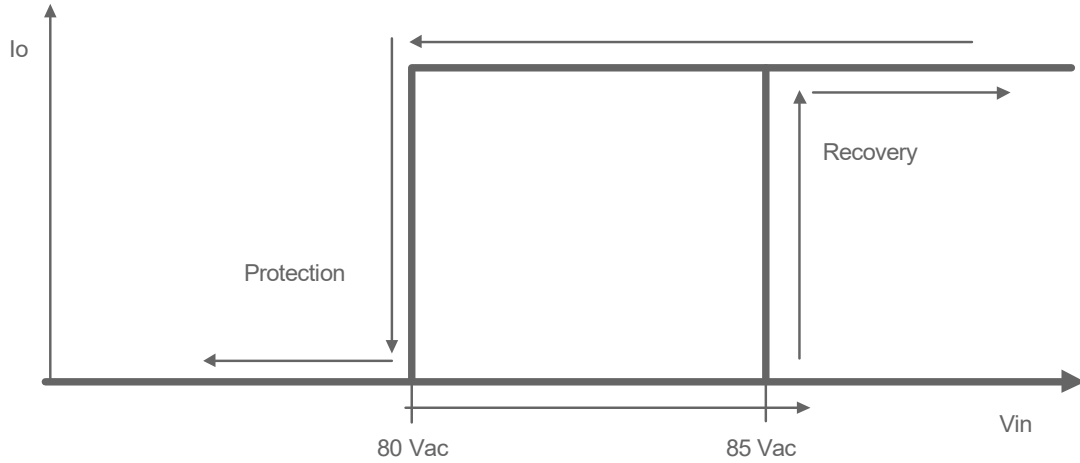

● Input Over Voltage Protection Diagram

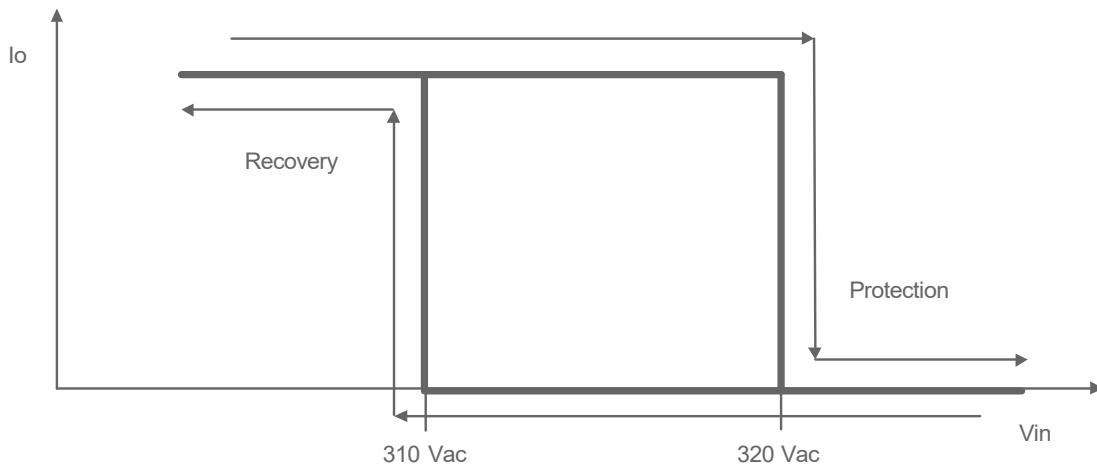

Dimming

● DALI-2 Dimming

The recommended implementation of the dimming control is provided below.

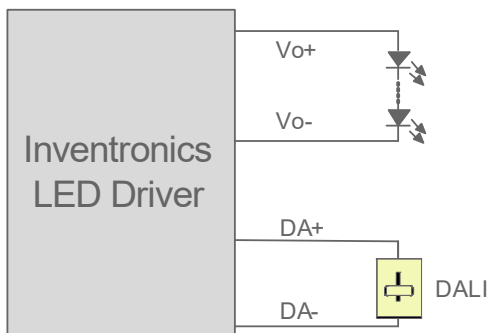

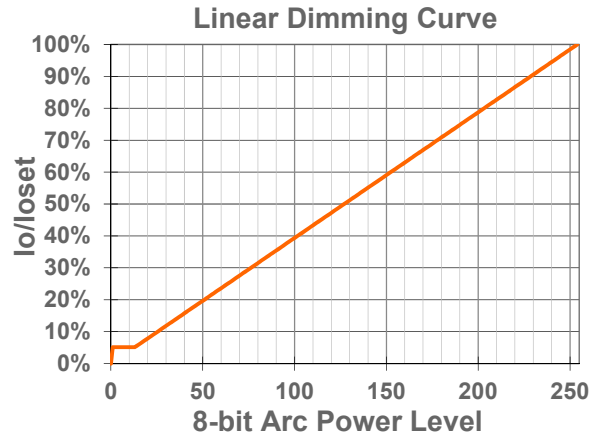
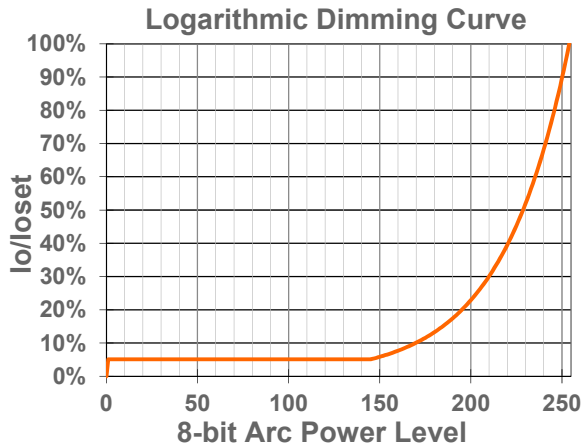

Implementation: DALI-2 Dimming

● Time Dimming

Time dimming control includes 3 kinds of modes, they are Self Adapting-Midnight, Self Adapting-Percentage and Traditional Timer.

- **Self Adapting-Midnight:** Automatically adjusts the dimming curve based on the on-time of past two days (if difference <15 minutes), assuming that the center point of the dimming curve is midnight local time.
- **Self Adapting-Percentage:** Automatically adjusts the on-time of each step by a constant percentage = (actual on-time for the past 2 days if difference <15 min) / (programmed on-time from the dimming curve).
- **Traditional Timer:** Follows the programmed timing curve after power on with no changes.

● Output Lumen Compensation

Output Lumen Compensation (OLC) may be used to maintain constant light output over the life of the LEDs by driving them at a reduced current when new, then gradually increasing the drive current over time to counteract LED lumen degradation.

● End Of Life

End-of-Life (EOL) is providing a visual notification to a user that the LED module has reached the end of manufacturer-specified life and that the replacement is recommended. Once active, an indication is given at each power-up of the driver, which the driver indicates this through a lower light output during the first 1 minute before normal operation is continued.

Programming Connection Diagram

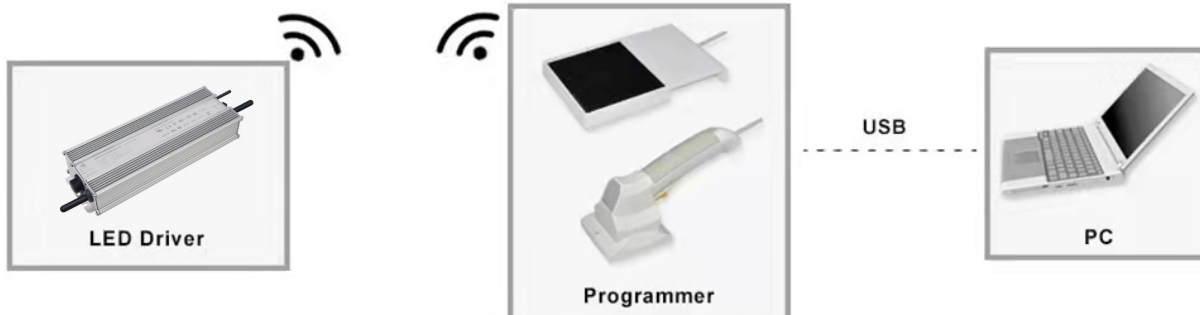

Note: The driver does not need to be powered on during the programming process.

- Please refer to [PRG-NFC-H](#) or [PRG-NFC-D2](#) (Programmer) datasheet for details.

Mechanical Outline

EUM-480S140BG

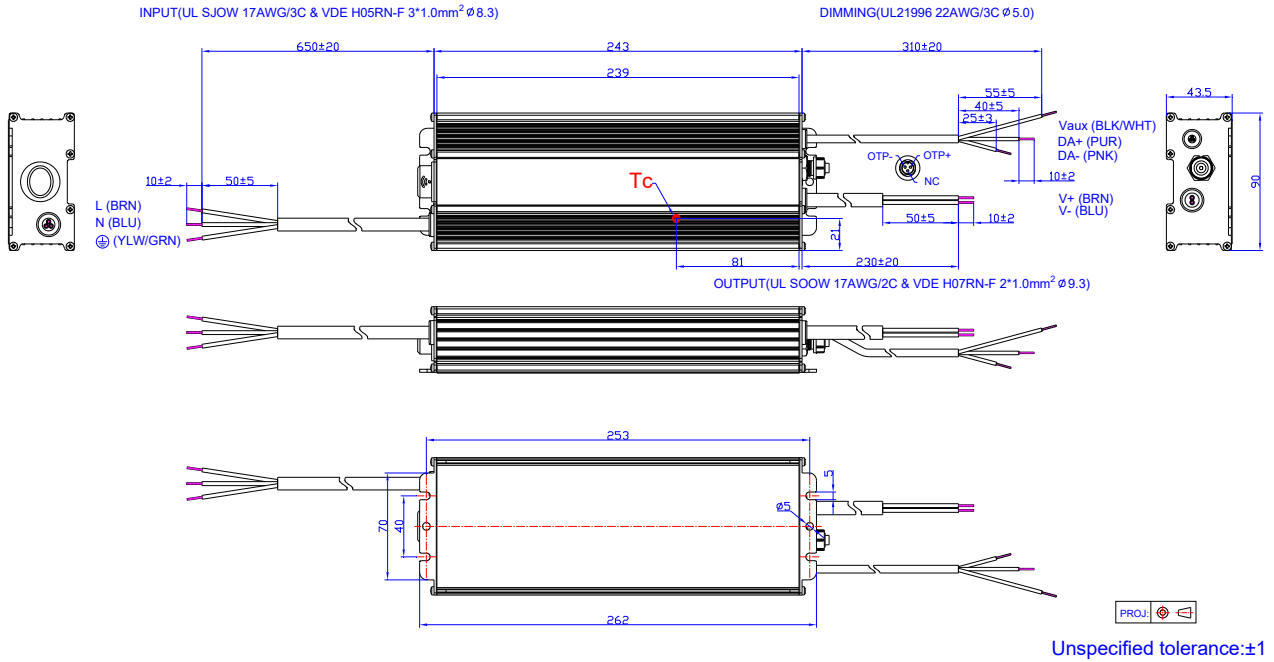

EUM-480S280BG/EUM-480S420BG/EUM-480S560BG

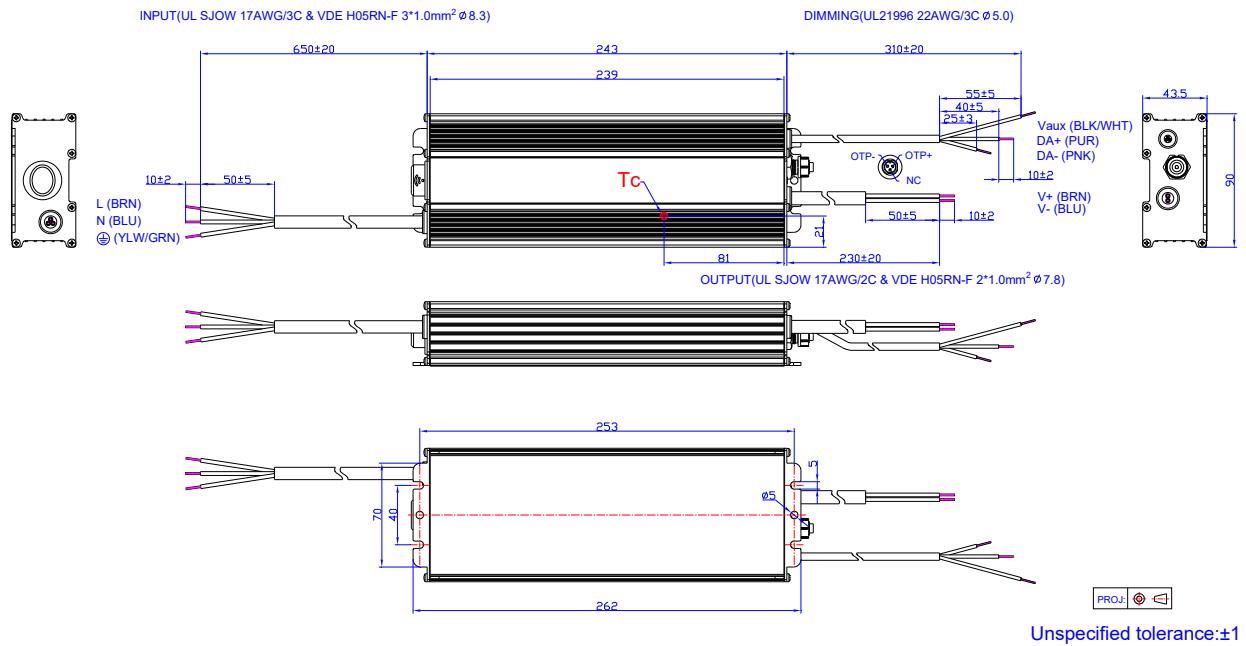

EUM-480S10ABG

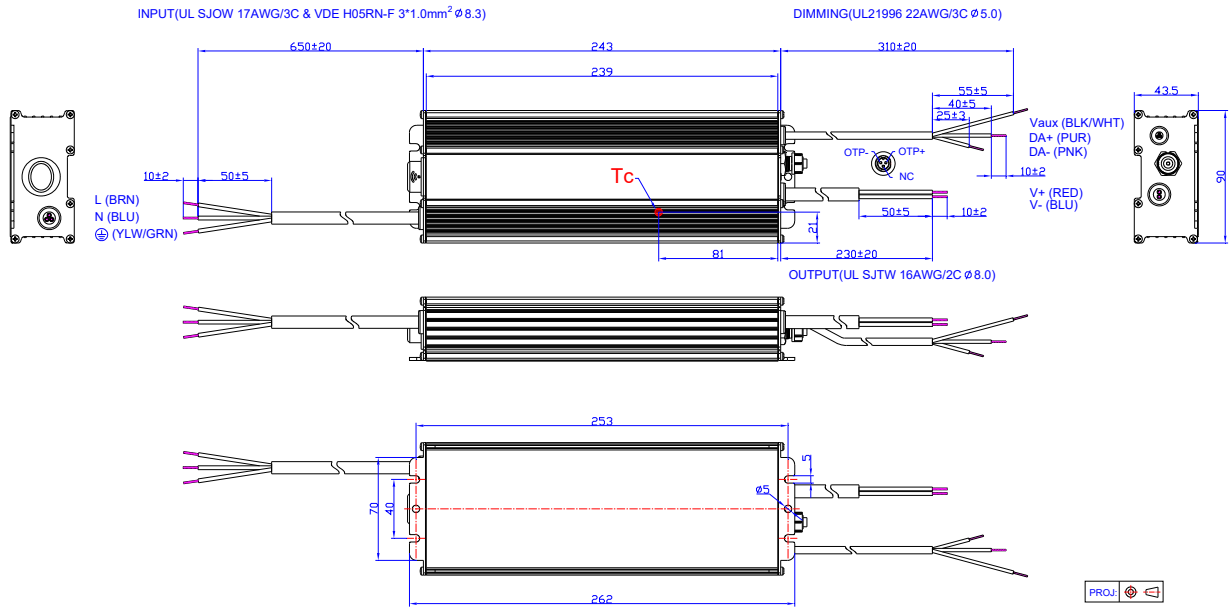

Unspecified tolerance: ±1

Optional Cable Parts CAB-OTPG

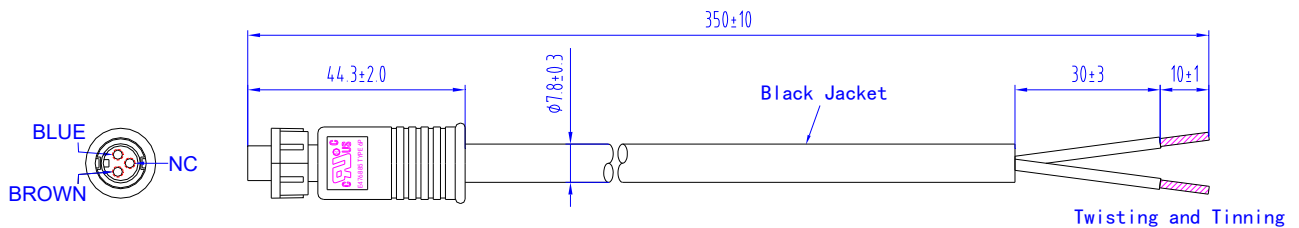

- The external thermal protection cable used for the EUM series drivers can be supplied by Inventronics, please contact the sales for ordering if necessary. For the details of cable, please refer to [CAB-OTPG \(Cable\) datasheet](#).

RoHS Compliance

Our products comply with reference to RoHS Directive (EU) 2015/863 amending 2011/65/EU, calling for the elimination of lead and other hazardous substances from electronic products.

Revision History

Change Date	Rev.	Description of Change		
		Item	From	To
2023-06-07	A	Datasheet Release	/	/
2023-11-15	B	Format	/	Updated
		KCC	/	Added
		Safety &EMC Compliance	/	Updated
		Inrush Current Waveform	/	Updated