

## Features

- Ultra High Efficiency (Up to 96%)
- Full Power at Wide Output Current Range (Constant Power)
- Adjustable Output Current (AOC) with Programmability
- Isolated 0-10V/PWM/3-Timer-Modes Dimmable
- Adjustable Dimming Curve
- INV Digital Dimming, UART Based Communication Protocol
- Dim-to-Off
- Minimum Dimming Level with 5% or 10% Selectable
- Hold Time Adjustable
- Fade Time Adjustable
- Always-on Auxiliary Power: 12Vdc, 250mA
- Low Inrush Current
- Output Lumen Compensation
- End-of-Life Indicator
- Input Surge Protection: DM 6kV, CM 10kV
- All-Around Protection: IUVP, IOVP, OVP, SCP, OTP
- IP66/IP67 and UL Dry/Damp/Wet Location
- TYPE HL, for Use in a Class I, Division 2 Hazardous (Classified) Location
- 5 Years Warranty



## Description

The ESM-880SxxxMx series is an 880W, constant-current, programmable and IP66/IP67 rated LED driver that operates from 249-528Vac input with excellent power factor. Created for many lighting applications including high mast, sports, UV-LED, aquaculture and horticulture, etc. It provides an auxiliary voltage and dim-to-off functionality for powering low voltage, wireless controls. The dimming control supports 0-10V dimming as well as two-way communication via Digital Dimming, a UART based communication protocol. The high efficiency of these drivers and compact metal case enables them to run cooler, significantly improving reliability and extending product life. To ensure trouble-free operation, protection is provided against input surge, input under voltage, input over voltage, output over voltage, short circuit, and over temperature.

## Models

Adjustable Output Current Range(A)	Full-Power Current Range(A) <sup>(1)</sup>	Default Output Current(A)	Output Voltage Range(Vdc)	Max. Output Power(W)	Typical Efficiency <sup>(2)</sup>	Typical Power Factor		Model Number <sup>(3)(5)</sup>
						277Vac	480Vac	
0.195-2.8	1.95-2.8	2.1	157-452	880	96.0%	0.99	0.96	ESM-880S280Mx
0.300-4.2	3.0-4.2	4.2	104-294	880	95.5%	0.99	0.96	ESM-880S420Mx
0.490-7.0	4.9-7.0	5.6	63.0-180	880	96.0%	0.99	0.96	ESM-880S700Mx
0.800-11.5	8.0-11.5	8.4	38.0-110	880	95.0%	0.99	0.96	ESM-880S11AMx <sup>(4)</sup>
1.630-20.0	16.3-20.0	20.0	22.0-54	880	95.5%	0.99	0.96	ESM-880S20AMx <sup>(4)</sup>

- Notes:** (1) Output current range with constant power at 880W.  
 (2) Measured at 100% load and 480Vac input (see below “General Specifications” for details).  
 (3) Certified voltage range: 277-480Vac  
 (4) SELV output  
 (5) x = G are UL Recognized and ENEC, etc. models; x = T are UL Class P models.

## I-V Operating Area

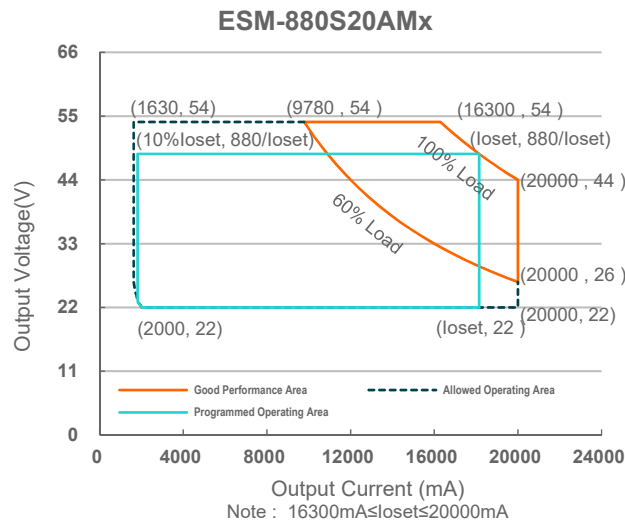
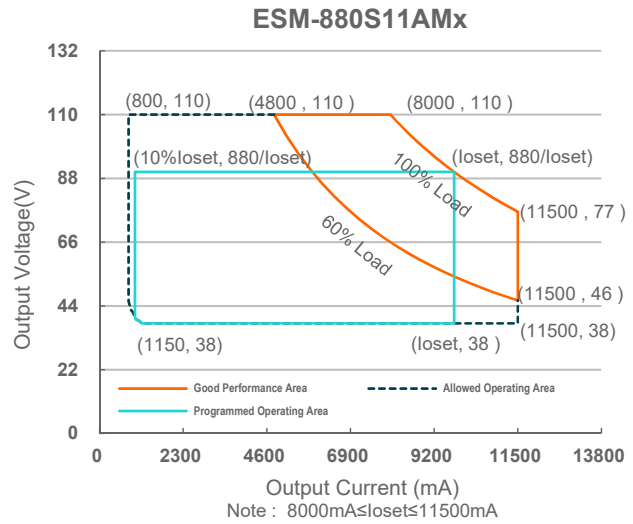
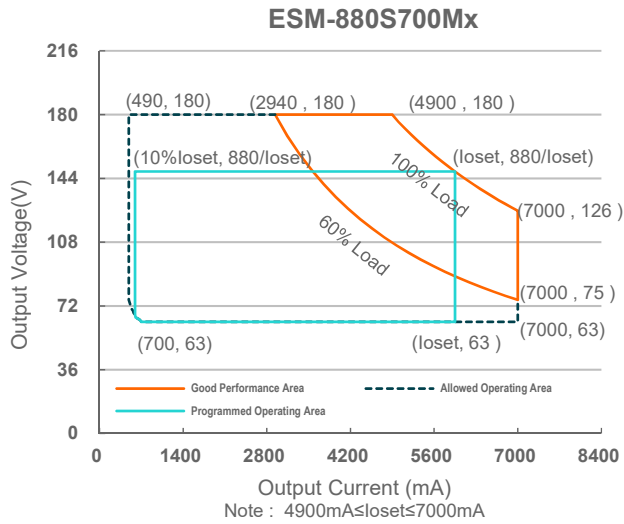
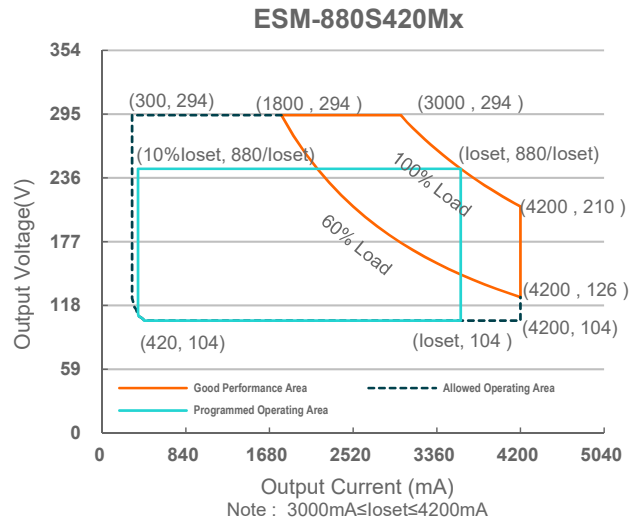
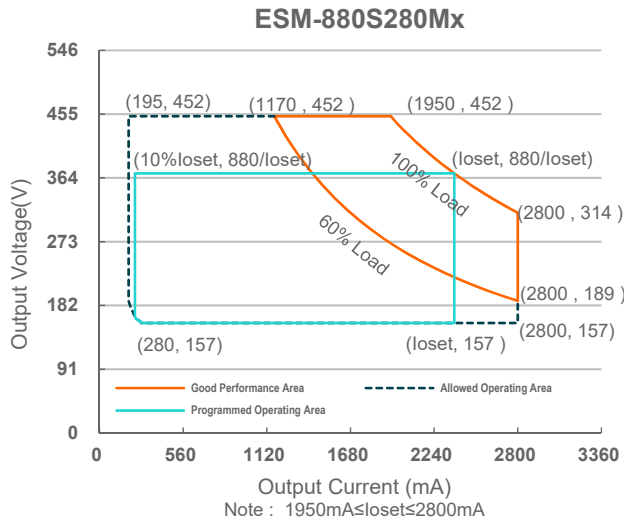

## Input Specifications

Parameter	Min.	Typ.	Max.	Notes
Input AC Voltage	249 Vac	-	528 Vac	
Input DC Voltage	352 Vdc	-	500 Vdc	
Input Frequency	47 Hz	-	63 Hz	
Leakage Current	-	-	0.75 MIU	UL 8750; 480Vac/60Hz
	-	-	0.70 mA	IEC 60598-1; 480Vac/60Hz
Input AC Current	-	-	3.79 A	Measured at 100% load and 277 Vac input.
	-	-	2.16 A	Measured at 100% load and 480 Vac input.
Inrush Current(I <sup>2</sup> t)	-	-	1.98 A <sup>2</sup> s	At 480Vac input, 25°C cold start, duration=6.6 ms, 10%I <sub>pk</sub> -10%I <sub>pk</sub> .
PF	0.90	-	-	At 277-480Vac,50-60Hz,60%-100% Load (528-880W)
THD	-	-	20%	

## Output Specifications

Parameter	Min.	Typ.	Max.	Notes
Output Current Tolerance	-5%loset	-	5%loset	100% load
Output Current Setting(loset) Range				
ESM-880S280Mx	195 mA	-	2800 mA	
ESM-880S420Mx	300 mA	-	4200 mA	
ESM-880S700Mx	490 mA	-	7000 mA	
ESM-880S11AMx	800 mA	-	11500 mA	
ESM-880S20AMx	1630 mA	-	20000 mA	
Output Current Setting Range with Constant Power				
ESM-880S280Mx	1950 mA	-	2800 mA	
ESM-880S420Mx	3000 mA	-	4200 mA	
ESM-880S700Mx	4900 mA	-	7000 mA	
ESM-880S11AMx	8000 mA	-	11500 mA	
ESM-880S20AMx	16300 mA	-	20000 mA	
Total Output Current Ripple (pk-pk)	-	5%lomax	10%lomax	100% load, 20 MHz BW
Output Current Ripple at < 200 Hz (pk-pk)	-	-	2%lomax	70%-100% load
Startup Overshoot Current	-	-	10%lomax	100% load
No Load Output Voltage				
ESM-880S280Mx	-	-	500 V	
ESM-880S420Mx	-	-	350 V	
ESM-880S700Mx	-	-	200 V	
ESM-880S11AMx	-	-	120 V	
ESM-880S20AMx	-	-	60 V	
Line Regulation	-	-	±0.5%	100% load
Load Regulation	-	-	±1.5%	
Turn-on Delay Time	-	-	0.5 s	Measured at 277-480Vac input, 60%-100% Load

## Output Specifications (Continued)

Parameter	Min.	Typ.	Max.	Notes
Temperature Coefficient of $I_{oSet}$	-	0.03%/°C	-	Case temperature = 0°C ~Tc max
12V Auxiliary Output Voltage	10.8 V	12 V	13.2 V	
12V Auxiliary Output Source Current	0 mA	-	250 mA	Return terminal is "Dim-"
12V Auxiliary Output Transient Peak Current@ 6W	-	-	500 mA	500mA peak for a maximum duration of 2.2ms in a 6.0ms period during which time the average should not exceed 250mA.
12V Auxiliary Output Transient Peak Current@10W	-	-	850 mA	850mA peak for a maximum duration of 1.3ms in a 5.2ms period during which time the average should not exceed 250mA.

## General Specifications

Parameter	Min.	Typ.	Max.	Notes
Efficiency at 277 Vac input:				
ESM-880S280Mx				
$I_o = 1950$ mA	93.0%	95.0%	-	
$I_o = 2800$ mA	93.0%	95.0%	-	
ESM-880S420Mx				
$I_o = 3000$ mA	92.0%	94.0%	-	
$I_o = 4200$ mA	92.5%	94.5%	-	
ESM-880S700Mx				
$I_o = 4900$ mA	93.0%	95.0%	-	
$I_o = 7000$ mA	92.5%	94.5%	-	
ESM-880S11AMx				
$I_o = 8000$ mA	92.0%	94.0%	-	
$I_o = 11500$ mA	92.0%	94.0%	-	
ESM-880S20AMx				
$I_o = 16300$ mA	93.0%	95.0%	-	
$I_o = 20000$ mA	92.5%	94.5%	-	
Efficiency at 400 Vac input:				
ESM-880S280Mx				
$I_o = 1950$ mA	94.0%	96.0%	-	
$I_o = 2800$ mA	94.0%	96.0%	-	
ESM-880S420Mx				
$I_o = 3000$ mA	93.0%	95.0%	-	
$I_o = 4200$ mA	93.5%	95.5%	-	
ESM-880S700Mx				
$I_o = 4900$ mA	94.0%	96.0%	-	
$I_o = 7000$ mA	93.5%	95.5%	-	
ESM-880S11AMx				
$I_o = 8000$ mA	93.0%	95.0%	-	
$I_o = 11500$ mA	93.0%	95.0%	-	
ESM-880S20AMx				
$I_o = 16300$ mA	93.5%	95.5%	-	
$I_o = 20000$ mA	93.0%	95.0%	-	

## General Specifications (Continued)

Parameter	Min.	Typ.	Max.	Notes	
Efficiency at 480 Vac input: ESM-880S280Mx I <sub>o</sub> = 1950 mA I <sub>o</sub> = 2800 mA ESM-880S420Mx I <sub>o</sub> = 3000 mA I <sub>o</sub> = 4200 mA ESM-880S700Mx I <sub>o</sub> = 4900 mA I <sub>o</sub> = 7000 mA ESM-880S11AMx I <sub>o</sub> = 8000 mA I <sub>o</sub> = 11500 mA ESM-880S20AMx I <sub>o</sub> = 16300 mA I <sub>o</sub> = 20000 mA	94.0% 94.0% 93.0% 93.5% 94.0% 94.0% 93.0% 93.0% 93.5% 93.0%	96.0% 96.0% 95.0% 95.5% 96.0% 96.0% 95.0% 95.0% 95.5% 95.0%	- - - - - - - - - -	Measured at 100% load and steady-state temperature in 25°C ambient; (Efficiency will be about 2.0% lower if measured immediately after startup.)	
Standby Power	-	1.5 W	-		Measured at 480Vac/50Hz; Dimming off
MTBF	-	217,000 Hours	-		Measured at 480Vac input, 80%Load and 25°C ambient temperature (MIL-HDBK-217F)
Lifetime	-	100,000 Hours	-		Measured at 480Vac input, 80%Load and 70°C case temperature; See lifetime vs. T <sub>c</sub> curve for the details
	-	50,000 Hours	-		Measured at 277Vac input, 100%Load and 40°C ambient temperature
Operating Case Temperature for Safety T <sub>c_s</sub>	-40°C	-	+90°C		
Operating Case Temperature for Warranty T <sub>c_w</sub>	-40°C	-	+80°C		Case temperature for 5 years warranty Humidity: 10%RH to 95%RH
Storage Temperature	-40°C	-	+85°C		Humidity: 5%RH to 95%RH
Dimensions Inches (L × W × H) Millimeters (L × W × H)		9.84 × 5.67 × 1.91 250 × 144 × 48.5			With mounting ear 10.83 × 5.67 × 1.91 275 × 144 × 48.5
Net Weight	-	3450 g	-		

## Dimming Specifications

Parameter	Min.	Typ.	Max.	Notes	
Absolute Maximum Voltage on the V <sub>dim</sub> (+) Pin	-20 V	-	20 V		
Source Current on V <sub>dim</sub> (+)Pin	200 uA	300 uA	450 uA	V <sub>dim</sub> (+) = 0 V	
Dimming Output Range with 10%-100% (Default)	ESM-880S280Mx ESM-880S420Mx ESM-880S700Mx ESM-880S11AMx ESM-880S20AMx	10%I <sub>o</sub> set	-	I <sub>o</sub> set	1950 mA ≤ I <sub>o</sub> set ≤ 2800 mA 3000 mA ≤ I <sub>o</sub> set ≤ 4200 mA 4900 mA ≤ I <sub>o</sub> set ≤ 7000 mA 8000 mA ≤ I <sub>o</sub> set ≤ 11500 mA 16300 mA ≤ I <sub>o</sub> set ≤ 20000 mA
	ESM-880S280Mx ESM-880S420Mx ESM-880S700Mx ESM-880S11AMx ESM-880S20AMx	195 mA 300 mA 490 mA 800 mA 1630 mA	-	I <sub>o</sub> set	195 mA ≤ I <sub>o</sub> set < 1950 mA 300 mA ≤ I <sub>o</sub> set < 3000 mA 490 mA ≤ I <sub>o</sub> set < 4900 mA 800 mA ≤ I <sub>o</sub> set < 8000 mA 1630 mA ≤ I <sub>o</sub> set < 16300 mA

## Dimming Specifications (Continued)

Parameter		Min.	Typ.	Max.	Notes
Dimming Output Range with 5%-100% (Settable)	ESM-880S280Mx ESM-880S420Mx ESM-880S700Mx ESM-880S11AMx ESM-880S20AMx	5% <i>I</i> <sub>load</sub>	-	<i>I</i> <sub>load</sub>	1950 mA ≤ <i>I</i> <sub>load</sub> ≤ 2800 mA 3000 mA ≤ <i>I</i> <sub>load</sub> ≤ 4200 mA 4900 mA ≤ <i>I</i> <sub>load</sub> ≤ 7000 mA 8000 mA ≤ <i>I</i> <sub>load</sub> ≤ 11500 mA 16300 mA ≤ <i>I</i> <sub>load</sub> ≤ 20000 mA
	ESM-880S280Mx ESM-880S420Mx ESM-880S700Mx ESM-880S11AMx ESM-880S20AMx	98 mA 150 mA 245 mA 400 mA 815 mA	-	<i>I</i> <sub>load</sub>	195 mA ≤ <i>I</i> <sub>load</sub> < 1950 mA 300 mA ≤ <i>I</i> <sub>load</sub> < 3000 mA 490 mA ≤ <i>I</i> <sub>load</sub> < 4900 mA 800 mA ≤ <i>I</i> <sub>load</sub> < 8000 mA 1630 mA ≤ <i>I</i> <sub>load</sub> < 16300 mA
Recommended Dimming Input Range		0 V	-	10 V	Default 0-10V dimming mode.
Dim off Voltage		0.35 V	0.5 V	0.65 V	
Dim on Voltage		0.55 V	0.7 V	0.85 V	
Hysteresis		-	0.2 V	-	
PWM_in High Level		3 V	-	10 V	Dimming mode set to PWM in Inventronics Programing Software.
PWM_in Low Level		-0.3 V	-	0.6 V	
PWM_in Frequency Range		200 Hz	-	3 KHz	
PWM_in Duty Cycle		1%	-	99%	
PWM Dimming off (Positive Logic)		3%	5%	8%	
PWM Dimming on (Positive Logic)		5%	7%	10%	
PWM Dimming off ( Negative Logic)		92%	95%	97%	
PWM Dimming on ( Negative Logic)		90%	93%	95%	
Hysteresis		-	2%	-	

## Safety & EMC Compliance

Safety Category	Standard
UL/CUL	UL 8750,CAN/CSA-C22.2 No. 250.13
ENEC & CE	EN 61347-1, EN 61347-2-13
UKCA	BS EN 61347-1, BS EN 61347-2-13
CB	IEC 61347-1, IEC 61347-2-13
EAC	TP TC 004, TP TC 020
Performance	Standard
ENEC	EN 62384

## Safety & EMC Compliance (Continued)

EMI Standards	Notes
BS EN/EN IEC 55015 <sup>(1)</sup>	Conducted emission Test & Radiated emission Test
BS EN/EN IEC 61000-3-2	Harmonic current emissions
BS EN/EN 61000-3-3	Voltage fluctuations & flicker
FCC Part 15 <sup>(1)</sup>	ANSI C63.4 Class B
	This device complies with Part 15 of the FCC Rules. Operation is subject to the following two conditions: [1] this device may not cause harmful interference, and [2] this device must accept any interference received, including interference that may cause undesired Operation.
EMS Standards	Notes
BS EN/EN 61000-4-2	Electrostatic Discharge (ESD): 8 kV air discharge, 4 kV contact discharge
BS EN/EN 61000-4-3	Radio-Frequency Electromagnetic Field Susceptibility Test-RS
BS EN/EN 61000-4-4	Electrical Fast Transient / Burst-EFT
BS EN/EN 61000-4-5	Surge Immunity Test: AC Power Line: Differential Mode 6 kV, Common Mode 10 kV
BS EN/EN 61000-4-6	Conducted Radio Frequency Disturbances Test-CS
BS EN/EN 61000-4-8	Power Frequency Magnetic Field Test
BS EN/EN 61000-4-11	Voltage Dips
BS EN/EN 61547	Electromagnetic Immunity Requirements Applies To Lighting Equipment

**Note:** (1) This LED driver meets the EMI specifications above, but EMI performance of a luminaire that contains it depends also on the other devices connected to the driver and on the fixture itself.

## Lifetime vs. Case Temperature

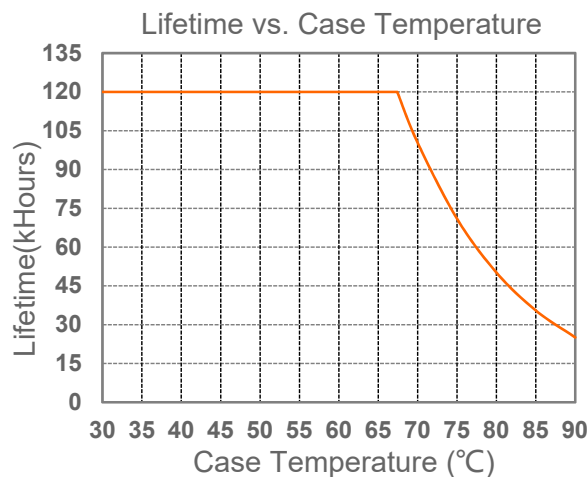

## Inrush Current Waveform

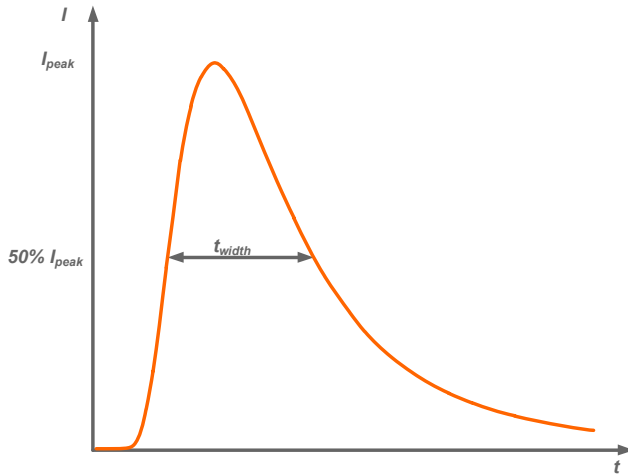

Input AC Voltage	$I_{peak}$	$t_{width}$ (@ 50% $I_{peak}$ )
480V	20.0A	2.0ms

## Efficiency vs. Load

ESM-880S280Mx( $I_o=1950mA$ )  
Efficiency vs. Output Voltage

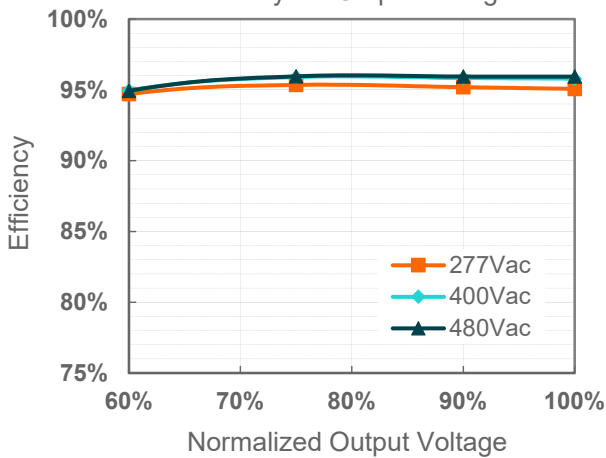

ESM-880S280Mx( $I_o=2800mA$ )  
Efficiency vs. Output Voltage

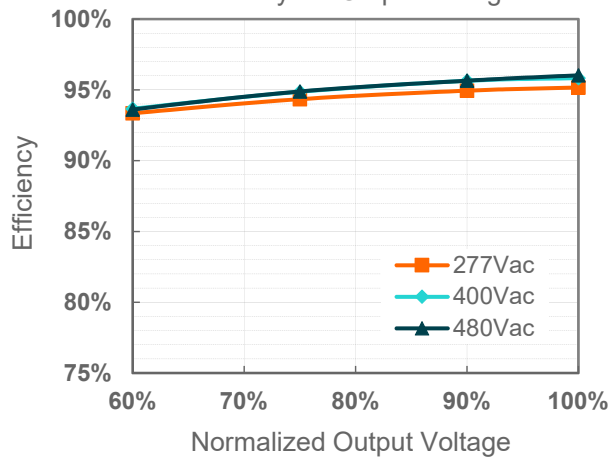

ESM-880S420Mx( $I_o=3000mA$ )  
Efficiency vs. Output Voltage

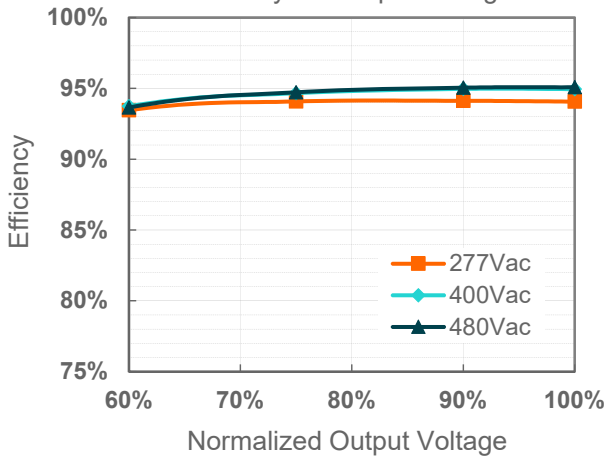

ESM-880S420Mx( $I_o=4200mA$ )  
Efficiency vs. Output Voltage

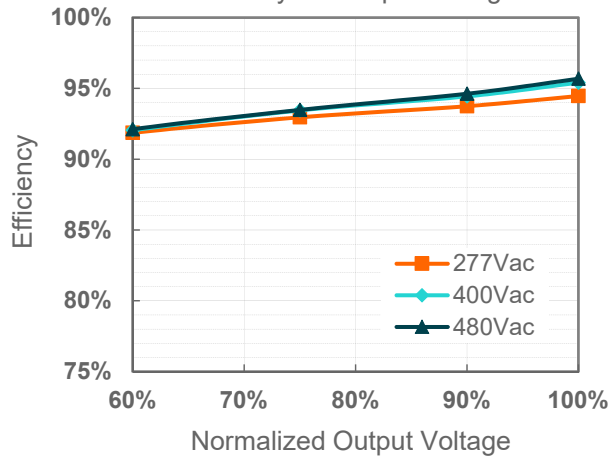



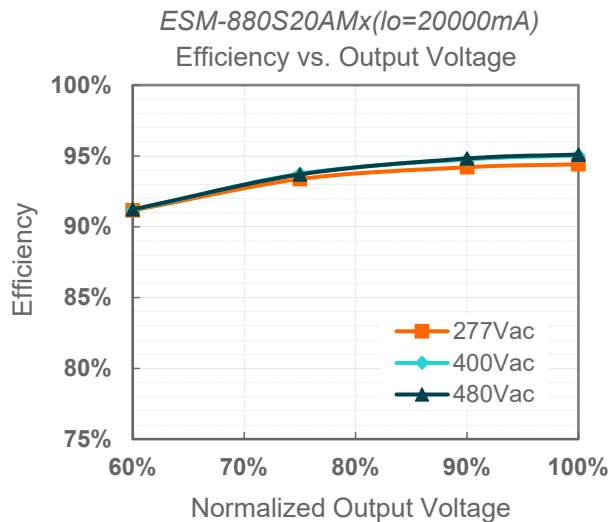
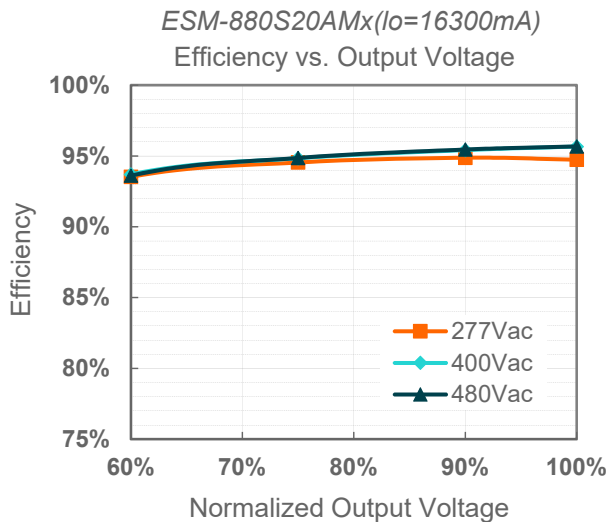
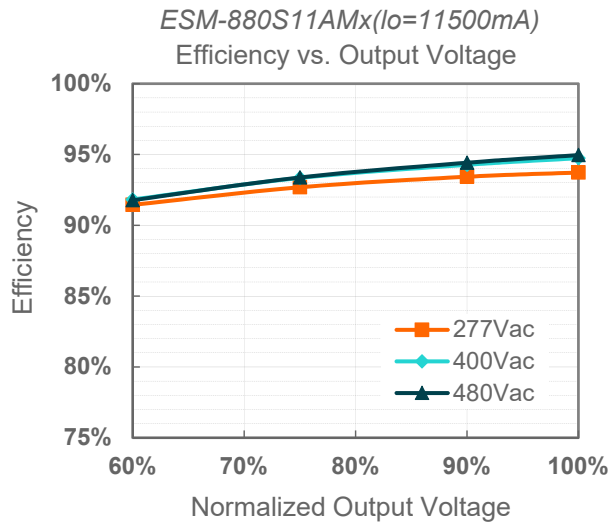
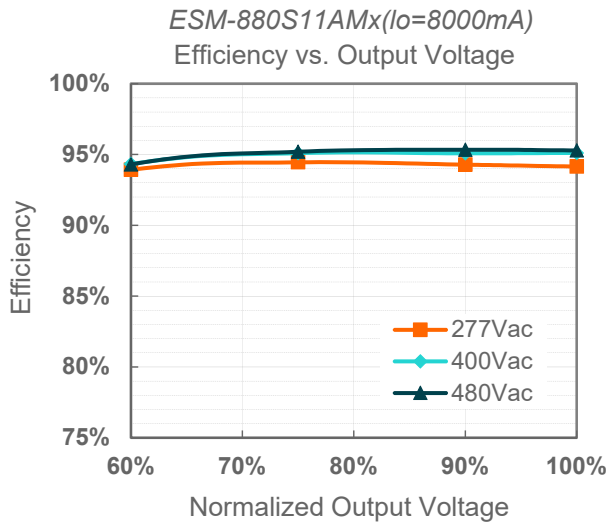
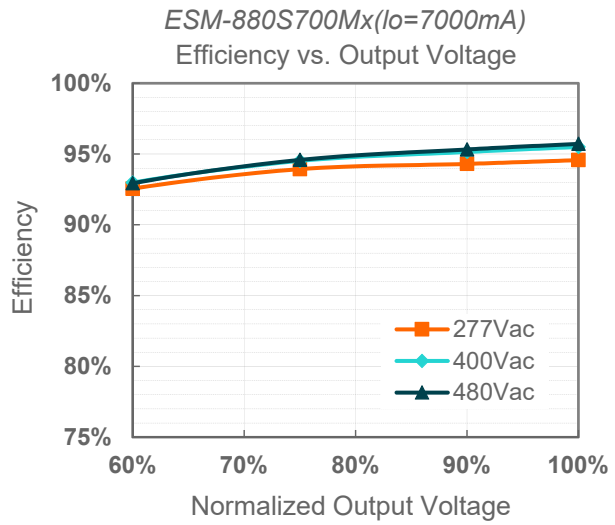
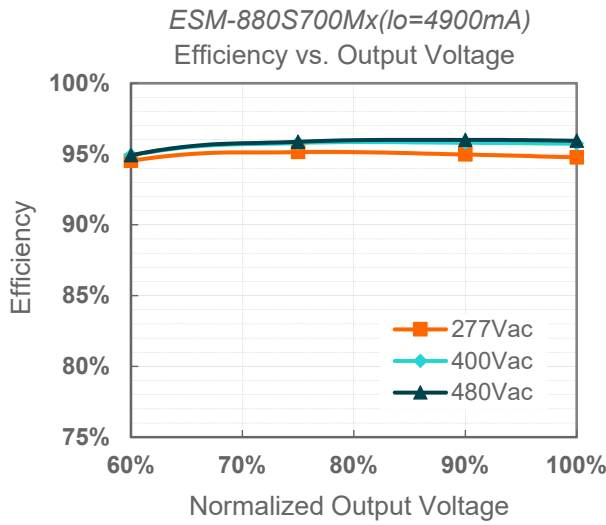

## Power Factor

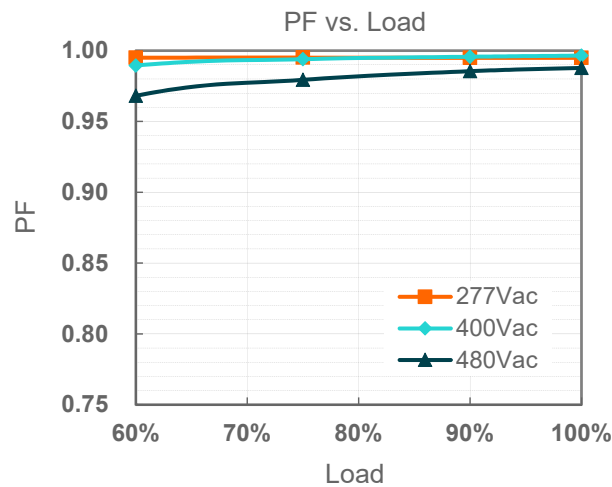

## Total Harmonic Distortion

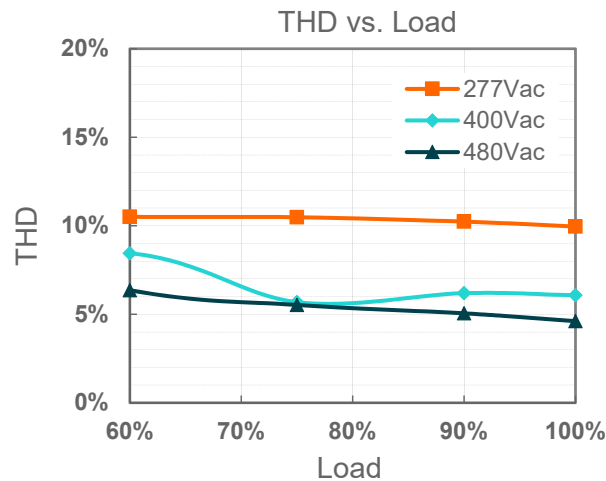

## Protection Functions

Parameter		Min.	Typ.	Max.	Notes
Over Temperature Protection		Decreases output current, returning to normal after over temperature is removed.			
Short Circuit Protection		Auto Recovery. No damage will occur when any output is short circuited. The output shall return to normal when the fault condition is removed.			
Over Voltage Protection		Limits output voltage at no load and in case the normal voltage limit fails.			
Input Under Voltage Protection (IUVP)	Input Protection Voltage	220 Vac	230 Vac	240 Vac	Turn off the output when the input voltage falls below protection voltage.
	Input Recovery Voltage	230 Vac	240 Vac	250 Vac	Auto Recovery. The driver will restart when the input voltage exceeds recovery voltage.
Input Over Voltage Protection (IOVP)	Input Over Voltage Protection	550 Vac	570 Vac	590 Vac	Turn off the output when the input voltage exceeds protection voltage.
	Input Over Voltage Recovery	530 Vac	550 Vac	570 Vac	Auto Recovery. The driver will restart when the input voltage falls below recovery voltage.
	Max. of Input Over Voltage	-	-	590 Vac	The driver can survive for 8 hours with input voltage stress of 590Vac.

● **Input Under Voltage Protection Diagram**

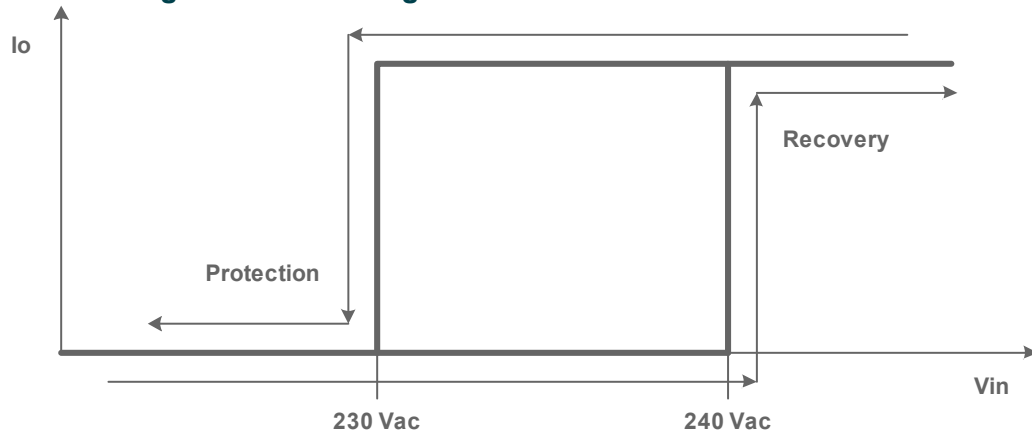

● **Input Over Voltage Protection Diagram**

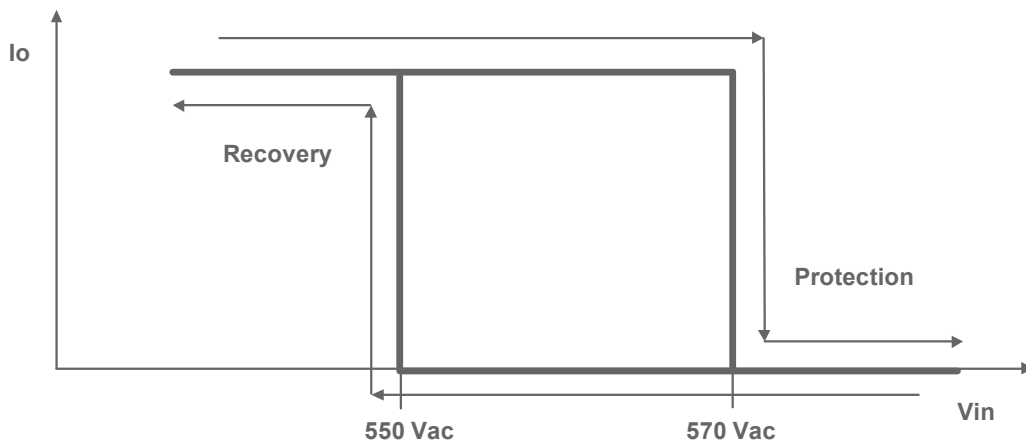

## Dimming

● **0-10V Dimming**

The recommended implementation of the dimming control is provided below.

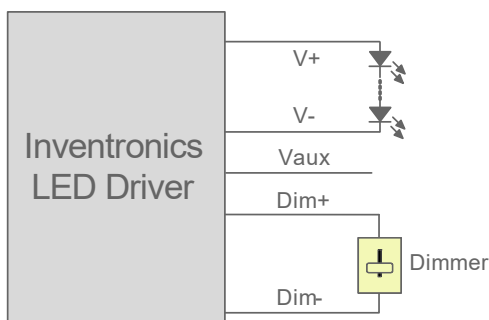

$I_o/I_{o\text{set}}$  vs. Dimming Voltage

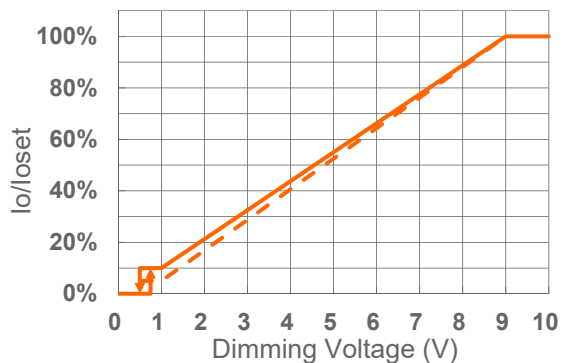

**Implementation 1: Positive logic**

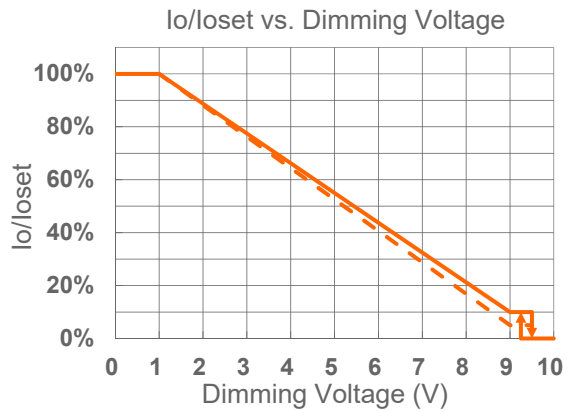
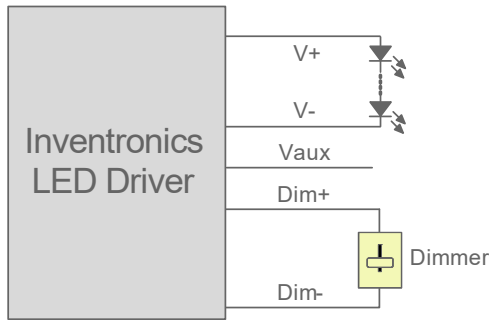

### Implementation 2: Negative logic

**Notes:**

1. Do NOT connect Dim- to the output V- or V+, otherwise the driver will not work properly.
2. The dimmer can also be replaced by an active 0-10V voltage source signal or passive components like zener.
3. When 0-10V negative logic dimming mode and Dim+ is open, the driver will dim to off and be standby.

### ● PWM Dimming

The recommended implementation of the dimming control is provided below.

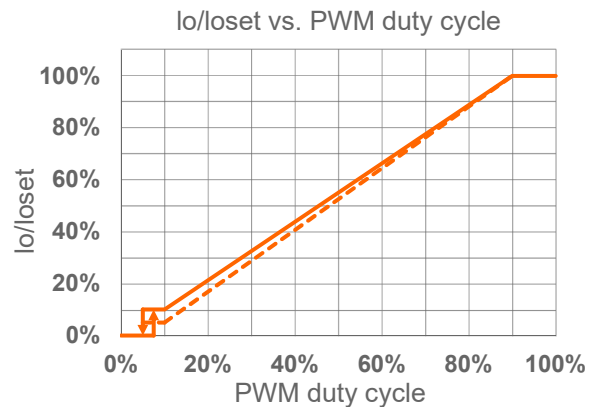
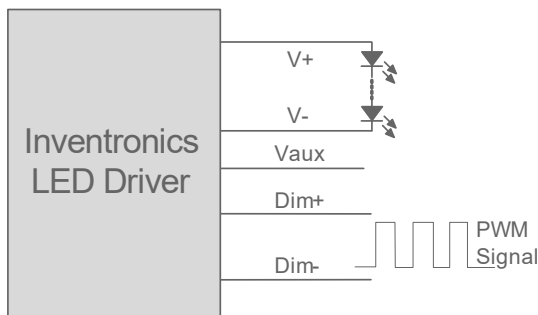

### Implementation 3: Positive logic

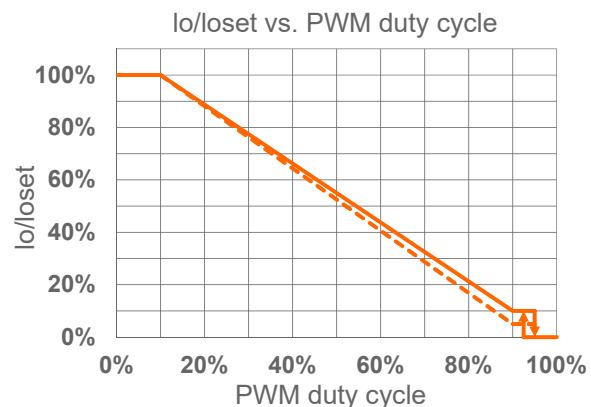
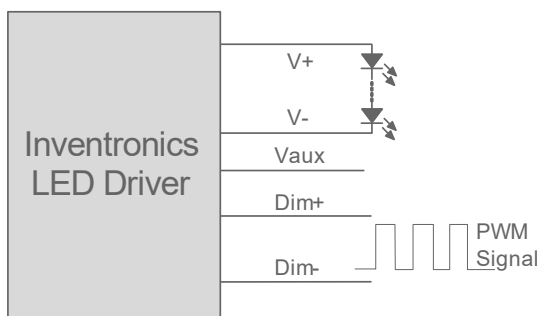

### Implementation 4: Negative logic

**Notes:**

1. Do NOT connect Dim- to the output V- or V+, otherwise the driver will not work properly.
2. When PWM negative logic dimming mode and Dim+ is open, the driver will dim to off and be standby.

## ● Adjustable Dimming Curve

0-10V dimming curve can be set as corresponding dimming voltage by Inventronics Multi Programmer. Take the positive logic dimming as an example, the recommended implementation of the dimming control is provided below.

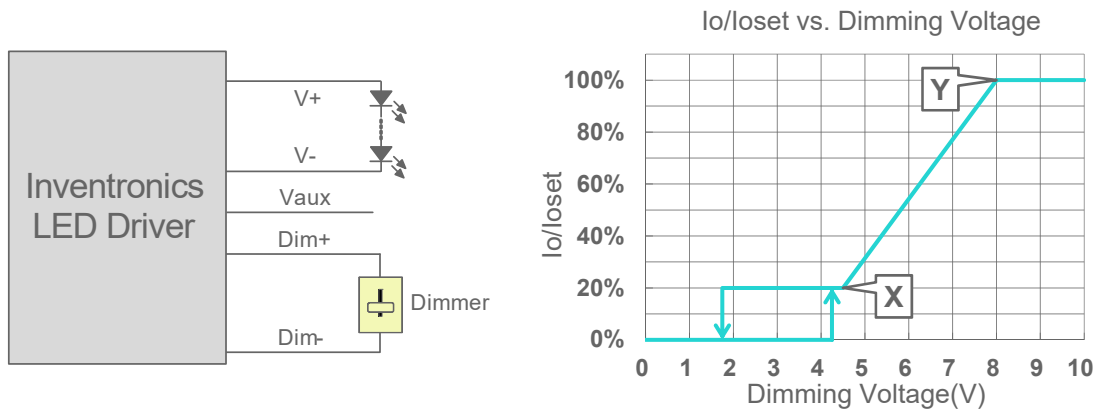

Implementation 5: Positive logic

### Notes:

1. Do NOT connect Dim- to the output V- or V+, otherwise the driver will not work properly.
2. The dimmer can also be replaced by an active 0-10V voltage source signal or passive components like zener.
3. When dimming voltage X point is set to be smaller than Y point, the dimming curve is positive logic; conversely, when X point is set to be bigger than Y point, the dimming curve is negative logic.
4. For best dimming accuracy, the difference between X point and Y point is advised more than 4V.
5. Dimming off voltage adjustable.

## ● Time Dimming

Time dimming control includes 3 kinds of modes, they are Self Adapting-Midnight, Self Adapting-Percentage and Traditional Timer.

- **Self Adapting-Midnight:** Automatically adjusts the dimming curve based on the on-time of past two days (if difference <15 minutes), assuming that the center point of the dimming curve is midnight local time.
- **Self Adapting-Percentage:** Automatically adjusts the on-time of each step by a constant percentage = (actual on-time for the past 2 days if difference <15 min) / (programmed on-time from the dimming curve).
- **Traditional Timer:** Follows the programmed timing curve after power on with no changes.

## ● Output Lumen Compensation

Output Lumen Compensation (OLC) may be used to maintain constant light output over the life of the LEDs by driving them at a reduced current when new, then gradually increasing the drive current over time to counteract LED lumen degradation.

## ● Minimum Dimming Level with 5% or 10% Selectable

The minimum dimming level can be set as 5% or 10% by Inventronics Multi Programmer, 10% is default.

## ● Hold Time Adjustable

When AC power is first applied to the LED driver, enabling a "Hold" period can allow devices powered by the Auxiliary voltage to stabilize before the driver fades up to the maximum dimming level. During this period, the driver will not respond to external dimming commands but will respond again after the hold time ends. Both the initial dimming percentage and the duration of this hold period can be adjusted by the Inventronics Multi Programmer. This function is disabled by default.

## ● Fade Time Adjustable

There is a "Fade" period after the "Hold" period. The soft-start time and dimming slope applied to all dimming transitions can be adjusted individually. It is adjusted by the Inventronics Multi Programmer. This function is disabled by default.

● **End Of Life**

End-of-Life (EOL) is providing a visual notification to a user that the LED module has reached the end of manufacturer-specified life and that the replacement is recommended. Once active, an indication is given at each power-up of the driver, which the driver indicates this through a lower light output during the first 1 minute before normal operation is continued.

● **Digital Dimming**

Inventronics Digital Dimming is a UART (Universal Asynchronous Receive Transmitter) based communication protocol. Please refer to [Inventronics Digital Dimming](#) file for details

**Programming Connection Diagram**

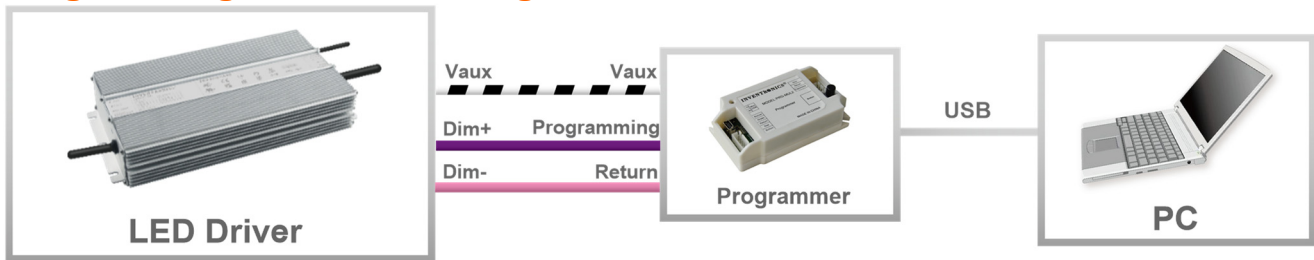

**Note:** The driver does not need to be powered on during the programming process.

● Please refer to [PRG-MUL2 \(Programmer\) datasheet](#) for details.

**Mechanical Outline**

ESM-880S280MG/ESM-880S420MG/ESM-880S700MG

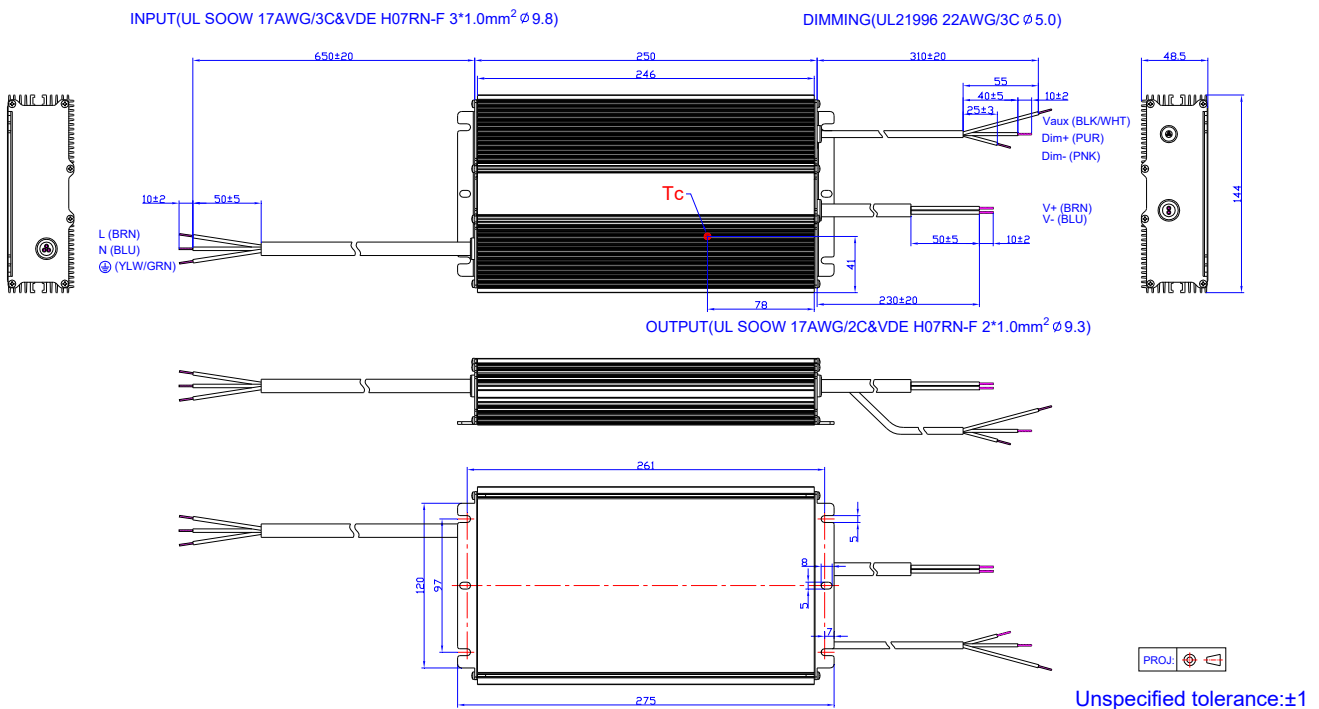

## ESM-880S11AMG

INPUT(UL SOOW 17AWG/3C&VDE H07RN-F 3\*1.0mm<sup>2</sup> Ø9.8)

DIMMING(UL21996 22AWG/3C Ø5.0)

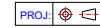
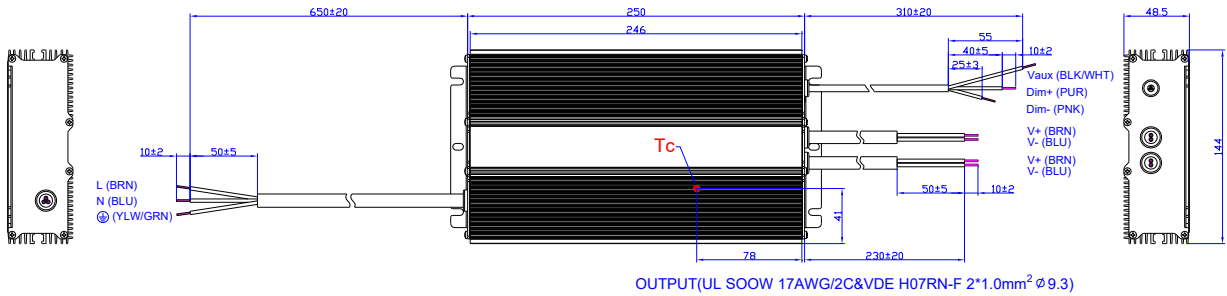

Unspecified tolerance:±1

## ESM-880S20AMG

INPUT(UL SOOW 17AWG/3C&VDE H07RN-F 3\*1.0mm<sup>2</sup> Ø9.8)

DIMMING(UL21996 22AWG/3C Ø5.0)

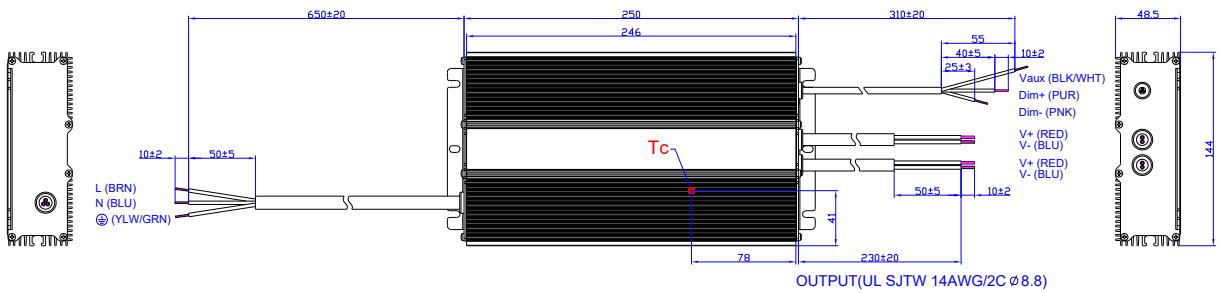

Unspecified tolerance:±1

ESM-880S280MT/ESM-880S420MT/ESM-880S700MT

INPUT(UL STW 18AWG/3C Ø9.5)

DIMMING(UL21996 22AWG/3C Ø 5.0)

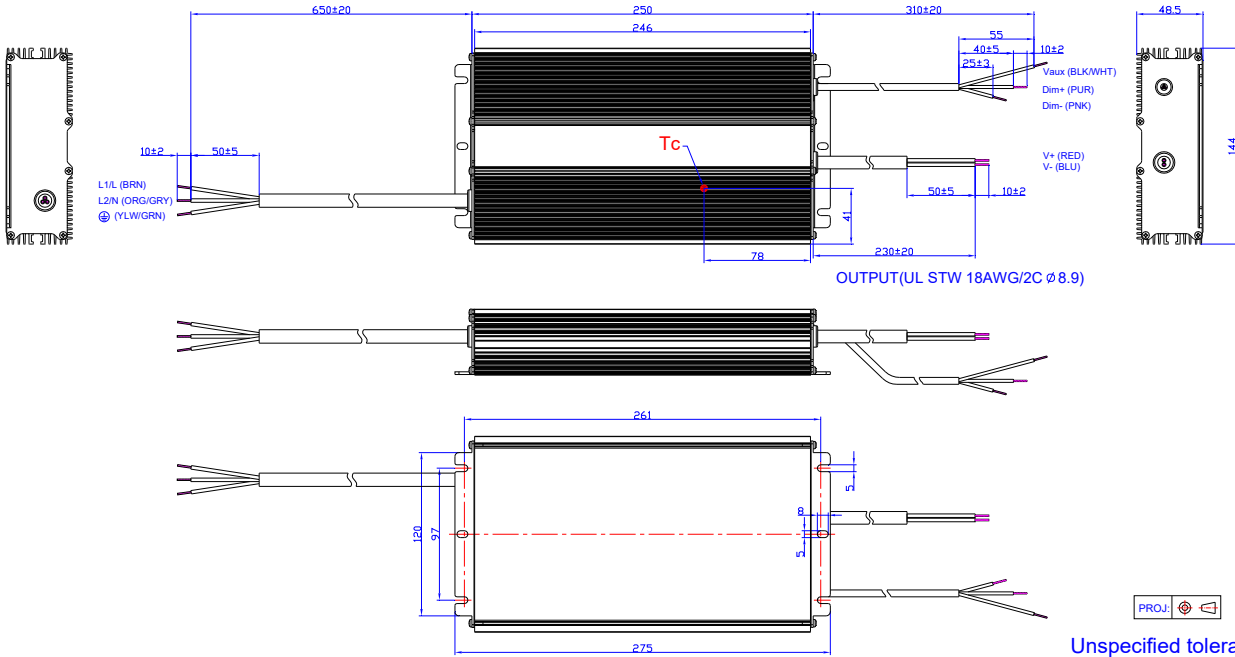

ESM-880S11AMT

INPUT(UL STW 18AWG/3C Ø9.5)

DIMMING(UL21996 22AWG/3C Ø 5.0)

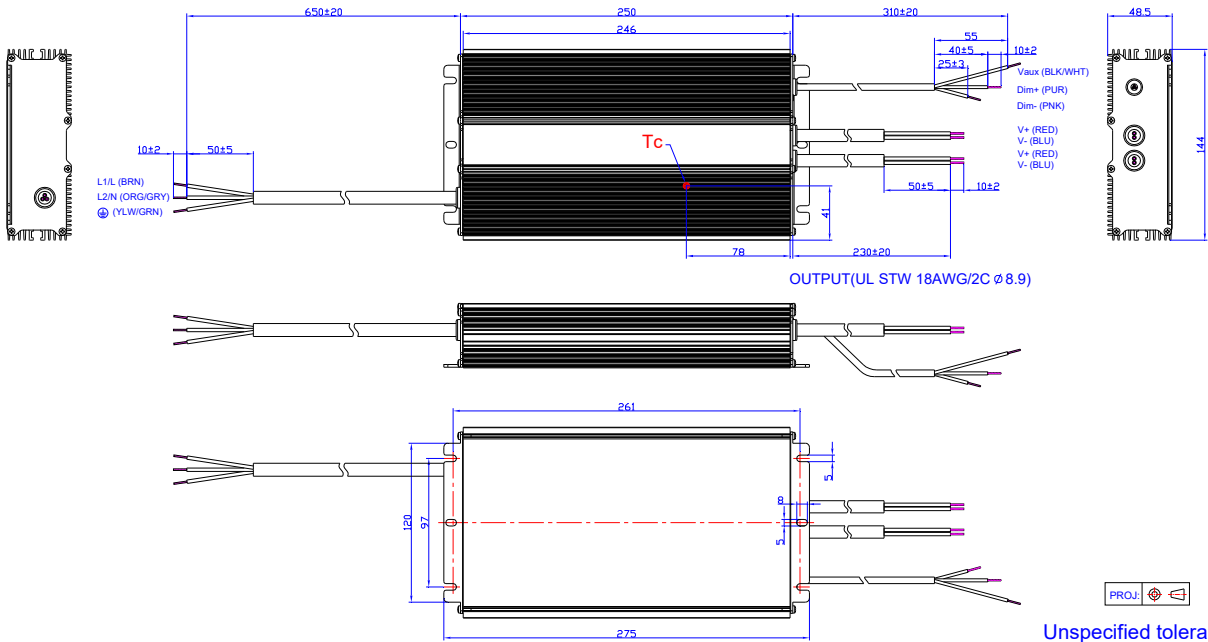



## ESM-880S20AMT

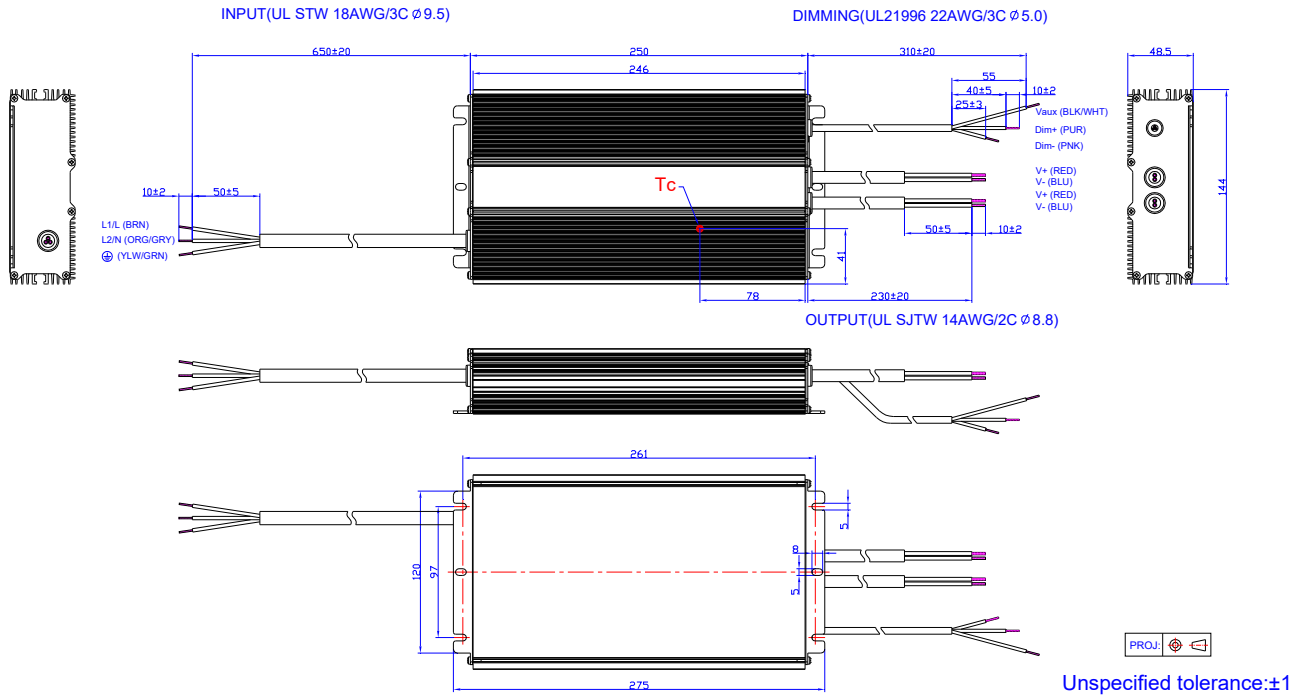

## RoHS Compliance

Our products comply with reference to RoHS Directive (EU) 2015/863 amending 2011/65/EU, calling for the elimination of lead and other hazardous substances from electronic products.

## Revision History

Change Date	Rev.	Description of Change		
		Item	From	To
2021-12-06	A	Datasheet Release	/	/
2022-01-22	B	Product Photograph	/	Updated
		EAC logo	/	Added
		Safety &EMC Compliance	/	Updated
2022-07-05	C	Safety &EMC Compliance	/	Updated
		Mechanical Outline	/	Updated
2023-07-06	D	Product Photograph	/	Updated
		Safety &EMC Compliance	/	Updated
		Dimming	/	Updated
		Programming Connection Diagram	/	Updated
		Mechanical Outline	/	Updated
2024-01-09	E	Format	/	Updated
		Features	/	Updated
		Inrush Current Waveform	/	Updated
		Dimming	/	Updated