

## Features

- Ultra High Efficiency (Up to 95%)
- Full Power at Wide Output Current Range (Constant Power)
- Adjustable Output Current (AOC) with Programmability
- Isolated 0-10V/10V PWM/Resistor/3-Timer-Modes Dimmable
- Adjustable Dimming Curve
- Dim-to-Off
- Hold Time Adjustable
- Fade-Time Adjustable
- Always-on Auxiliary Power: 12Vdc, 250mA
- Output Lumen Compensation
- End-of-Life Indicator
- Input Surge Protection: DM 6kV, CM 6kV
- All-Around Protection: OVP, SCP, OTP
- IP65 and UL Dry/Damp Location (MF models)
- IP66/IP67 and UL Dry/Damp/Wet Location (MG/MT models)
- TYPE HL, for Use in a Class I, Division 2 Hazardous (Classified) Location
- 5 Years Warranty



## Description

The SSM-330SxxxMx series is a 330W, constant-current, programmable LED driver that operates from 249-528Vac input with excellent power factor. Created for many lighting applications including Horticulture, High bay, etc. The high efficiency of this driver enables it to run cooler, significantly improving reliability and extending product life. To ensure trouble-free operation, protection is provided against input surge, output over voltage, short circuit, and over temperature.

## Models

| Adjustable Output Current Range(mA) | Full-Power Current Range(mA) <sup>(1)</sup> | Default Output Current(mA) | Output Voltage Range(Vdc) | Max. Output Power(W) | Typical Efficiency <sup>(2)</sup> | Typical Power Factor |        | Model Number <sup>(3)(4)(5)</sup> |
|-------------------------------------|---|----------------------------|---------------------------|----------------------|-----------------------------------|----------------------|--------|-----------------------------------|
|                                     |   |                            |                           |                      |                                   | 277Vac               | 480Vac |                                   |
| 610-6900                            | 6100-6900                                   | 6100                       | 34-54                     | 330                  | 95.0%                             | 0.99                 | 0.96   | SSM-330S690Mx                     |

- Notes:** (1) Output current range with constant power at 330W.  
 (2) Measured at 100% load and 480Vac input (see below "General Specifications" for details).  
 (3) Certified input voltage range: 277-480Vac.  
 (4) SELV output.  
 (5) x = F are UL Recognized, CE (built-in use), etc. models with flying leads; x = G are UL Recognized, CE, etc. models; x = T are UL Recognized, CE (built-in use), etc. models. See below "Mechanical Outline" for details.

## I-V Operation Area

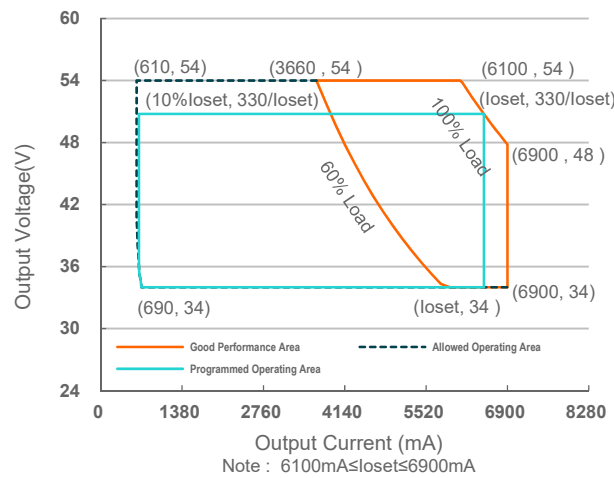

## Input Specifications

| Parameter                        | Min.    | Typ. | Max.                  | Notes  |
|----------------------------------|---------|------|-----------------------|--|
| Input AC Voltage                 | 249 Vac | -    | 528 Vac               |  |
| Input DC Voltage                 | 352 Vdc | -    | 500 Vdc               |  |
| Input Frequency                  | 47 Hz   | -    | 63 Hz                 |  |
| Leakage Current                  | -       | -    | 0.75 MIU              | UL 8750; 480Vac/60Hz   |
|                                  | -       | -    | 0.70 mA               | IEC 60598-1; 480Vac/60Hz   |
| Input AC Current                 | -       | -    | 1.43 A                | Measured at 100% load and 277 Vac input.   |
|                                  | -       | -    | 0.85 A                | Measured at 100% load and 480 Vac input.   |
| Inrush Current(I <sup>2</sup> t) | -       | -    | 1.19 A <sup>2</sup> s | At 480Vac input, 25°C cold start, duration=3.84 ms, 10%I <sub>pk</sub> -10%I <sub>pk</sub> . |
| PF                               | 0.9     | -    | -                     | At 277-480Vac, 50-60Hz, 60%-100% load (198-330W)   |
| THD                              | -       | -    | 20%                   |  |

## Output Specifications

| Parameter  | Min.              | Typ.                 | Max.                  | Notes                             |
|--|-------------------|----------------------|-----------------------|-----------------------------------|
| Output Current Tolerance                         | -5%I <sub>o</sub> | -                    | 5%I <sub>o</sub>      | At 100% load condition            |
| Output Current Setting(I <sub>o</sub> set) Range |                   |                      |                       |                                   |
| SSM-330S690Mx                                    | 610 mA            | -                    | 6900 mA               |                                   |
| Output Current Setting Range with Constant Power |                   |                      |                       |                                   |
| SSM-330S690Mx                                    | 6100 mA           | -                    | 6900 mA               |                                   |
| Total Output Current Ripple (pk-pk)              | -                 | 5%I <sub>o</sub> max | 10%I <sub>o</sub> max | At 100% load condition. 20 MHz BW |

## Output Specifications (Continued)

| Parameter                                       | Min.   | Typ.                | Max.                 | Notes  |
|---|--------|---------------------|----------------------|--|
| Output Current Ripple at < 200 Hz (pk-pk)       | -      | 2%I <sub>omax</sub> | -                    | At 100% load condition. Only this component of ripple is associated with visible flicker.                            |
| Startup Overshoot Current                       | -      | -                   | 10%I <sub>omax</sub> | At 100% load condition   |
| No Load Output Voltage<br>SSM-330S690Mx         | -      | -                   | 60 V                 |  |
| Line Regulation                                 | -      | -                   | ±0.5%                | Measured at 100% load  |
| Load Regulation                                 | -      | -                   | ±3.0%                |  |
| Turn-on Delay Time                              | -      | -                   | 0.5 s                | Measured at 277-480Vac input, 60%-100%load   |
| Temperature Coefficient of I <sub>o</sub> set   | -      | 0.03%/°C            | -                    | Case temperature = 0°C ~T <sub>c</sub> max   |
| 12V Auxiliary Output Voltage                    | 10.8 V | 12 V                | 13.2 V               |  |
| 12V Auxiliary Output Source Current             | 0 mA   | -                   | 250 mA               | Return terminal is "Dim"   |
| 12V Auxiliary Output Transient Peak Current@6W  | -      | -                   | 500 mA               | 500mA peak for a maximum duration of 2.2 ms in a 6.0ms period during which time the average should not exceed 250mA. |
| 12V Auxiliary Output Transient Peak Current@10W | -      | -                   | 850 mA               | 850mA peak for a maximum duration of 1.3 ms in a 5.2ms period during which time the average should not exceed 250mA. |

## General Specifications

| Parameter   | Min.           | Typ.           | Max.   | Notes  |
|---|----------------|----------------|--------|--|
| Efficiency at 277 Vac input:<br>SSM-330S690Mx<br>I <sub>o</sub> =6100 mA<br>I <sub>o</sub> =6900 mA | 92.0%<br>92.0% | 94.0%<br>94.0% | -<br>- | Measured at 100% load and steady-state temperature in 25°C ambient; (Efficiency will be about 2.0% lower if measured immediately after startup.) |
| Efficiency at 400 Vac input:<br>SSM-330S690Mx<br>I <sub>o</sub> =6100 mA<br>I <sub>o</sub> =6900 mA | 93.0%<br>93.0% | 95.0%<br>95.0% | -<br>- | Measured at 100% load and steady-state temperature in 25°C ambient; (Efficiency will be about 2.0% lower if measured immediately after startup.) |
| Efficiency at 480 Vac input:<br>SSM-330S690Mx<br>I <sub>o</sub> =6100 mA<br>I <sub>o</sub> =6900 mA | 93.0%<br>93.0% | 95.0%<br>95.0% | -<br>- | Measured at 100% load and steady-state temperature in 25°C ambient; (Efficiency will be about 2.0% lower if measured immediately after startup.) |
| Standby Power   | -              | 1.5 W          | -      | Measured at 480Vac/60Hz; Dimming off   |
| MTBF  | -              | 258,000 Hours  | -      | Measured at 480Vac input, 80%load and 25°C ambient temperature (MIL-HDBK-217F)   |
| Lifetime  | -              | 108,000 Hours  | -      | Measured at 480Vac input, 80%load and 70°C case temperature; See lifetime vs. T <sub>c</sub> curve for the details                               |
|   | -              | 110,000 Hours  | -      | Measured at 277Vac input, 100%load and 40°C ambient temperature  |
| Operating Case Temperature for Safety T <sub>c_s</sub>  | -40°C          | -              | +90°C  |  |

## General Specifications (Continued)

| Parameter  |   | Min.                                     | Typ.   | Max.  | Notes   |
|--|---|--|--------|-------|---|
| Operating Case Temperature for Warranty T <sub>c_w</sub> |   | -40°C                                    | -      | +80°C | Case temperature for 5 years warranty<br>Humidity: 10% RH to 95% RH |
| Storage Temperature                                      |   | -40°C                                    | -      | +85°C | Humidity: 5% RH to 95% RH   |
| Dimensions   | MF models<br>Inches (L × W × H)<br>Millimeters (L × W × H)    | 15.43 × 1.71 × 1.24<br>392 × 43.5 × 31.5 |        |       | With mounting ear<br>16.38 × 1.71 × 1.24<br>416 × 43.5 × 31.5       |
|  | MG/MT models<br>Inches (L × W × H)<br>Millimeters (L × W × H) | 15.83 × 1.71 × 1.24<br>402 × 43.5 × 31.5 |        |       | With mounting ear<br>16.77 × 1.71 × 1.24<br>426 × 43.5 × 31.5       |
| Net Weight   | MF models   | -  | 1100 g | -     |   |
|  | MG/MT models  | -  | 1290 g | -     |   |

## Dimming Specifications

| Parameter  |               | Min.     | Typ.   | Max.   | Notes                       |
|--|---------------|----------|--------|--------|-----------------------------|
| Absolute Maximum Voltage on the V <sub>dim</sub> (+) Pin |               | -20 V    | -      | 20 V   |                             |
| Source Current on V <sub>dim</sub> (+)Pin                |               | 90 μA    | 100 μA | 110 μA | V <sub>dim</sub> (+) = 0 V  |
| Dimming Output Range                                     | SSM-330S690Mx | 10%loset | -      | loset  | 6100 mA ≤ loiset ≤ 6900 mA  |
|  | SSM-330S690Mx | 610 mA   | -      | loset  | 610 mA ≤ loiset ≤ 6100 mA   |
| Recommended Dimming Input Range                          |               | 0 V      | -      | 10 V   | Default 0-10V dimming mode. |
| Dim off Voltage  |               | 0.35 V   | 0.5 V  | 0.65 V |                             |
| Dim on Voltage   |               | 0.55 V   | 0.7 V  | 0.85 V |                             |
| Hysteresis   |               | -        | 0.2 V  | -      |                             |
| PWM <sub>in</sub> High Level                             |               | -        | 10 V   | -      |                             |
| PWM <sub>in</sub> Low Level                              |               | -        | 0 V    | -      |                             |
| PWM <sub>in</sub> Frequency Range                        |               | 200 Hz   | -      | 3 KHz  |                             |
| PWM <sub>in</sub> Duty Cycle                             |               | 0%       | -      | 100%   |                             |
| PWM Dimming off  |               | 3%       | 5%     | 8%     |                             |
| PWM Dimming on   |               | 5%       | 7%     | 10%    |                             |
| Hysteresis   |               | -        | 2%     | -      |                             |

## Safety & EMC Compliance

| Safety Category             | Standard  |
|-----------------------------|---|
| UL/CUL                      | UL 8750,CAN/CSA-C22.2 No. 250.13  |
| CE                          | EN 61347-1, EN 61347-2-13   |
| CB                          | IEC 61347-1, IEC 61347-2-13   |
| EMI Standards               | Notes   |
| EN IEC 55015 <sup>(1)</sup> | Conducted emission Test & Radiated emission Test  |
| EN IEC 61000-3-2            | Harmonic current emissions  |
| EN 61000-3-3                | Voltage fluctuations & flicker  |
| FCC Part 15 <sup>(1)</sup>  | ANSI C63.4 Class B  |
|                             | This device complies with Part 15 of the FCC Rules. Operation is subject to the following two conditions: [1] this device may not cause harmful interference, and [2] this device must accept any interference received, including interference that may cause undesired operation. |
| EMS Standards               | Notes   |
| EN 61000-4-2                | Electrostatic Discharge (ESD): 8 kV air discharge, 4 kV contact discharge   |
| EN 61000-4-3                | Radio-Frequency Electromagnetic Field Susceptibility Test-RS  |
| EN 61000-4-4                | Electrical Fast Transient / Burst-EFT   |
| EN 61000-4-5                | Surge Immunity Test: AC Power Line: Differential Mode 6 kV, Common Mode 6 kV  |
| EN 61000-4-6                | Conducted Radio Frequency Disturbances Test-CS  |
| EN 61000-4-8                | Power Frequency Magnetic Field Test   |
| EN 61000-4-11               | Voltage Dips  |
| EN 61547                    | Electromagnetic Immunity Requirements Applies To Lighting Equipment   |
| ANSI Standards              | Notes   |
| ANSI C82.77-5               | 6kV combi-wave surge rating to comply with ANSI C82.77-5 CAT low  |

**Note:** (1) This LED driver meets the EMI specifications above, but EMI performance of a Luminaire that contains it depends also on the other devices connected to the driver and on the fixture itself.

## Lifetime vs. Case Temperature

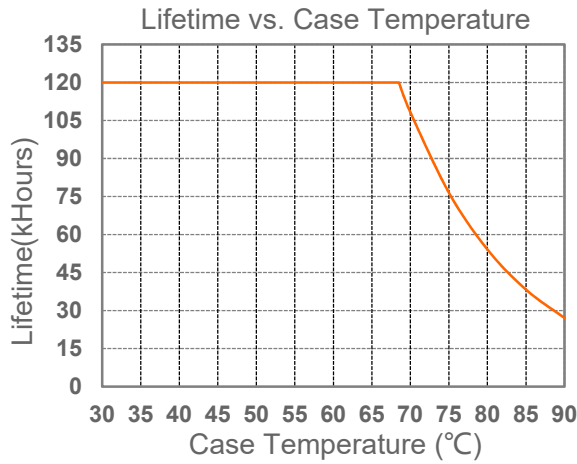

## Inrush Current Waveform

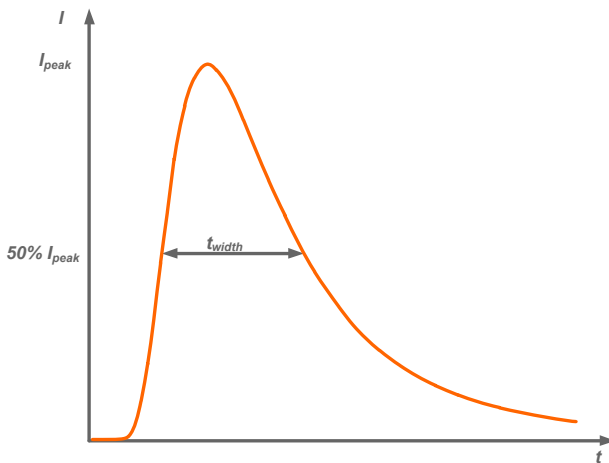

| Input AC Voltage | $I_{peak}$ | $t_{width}$<br>(@ 50% $I_{peak}$ ) |
|------------------|------------|------------------------------------|
| 480Vac           | 20.3A      | 1.12ms                             |

## Efficiency vs. Load

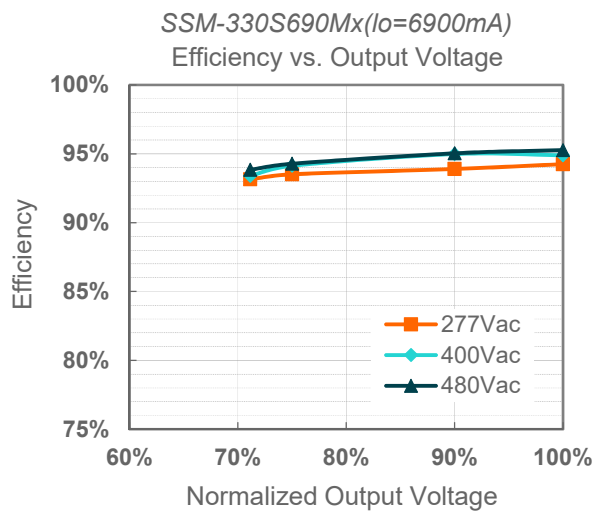
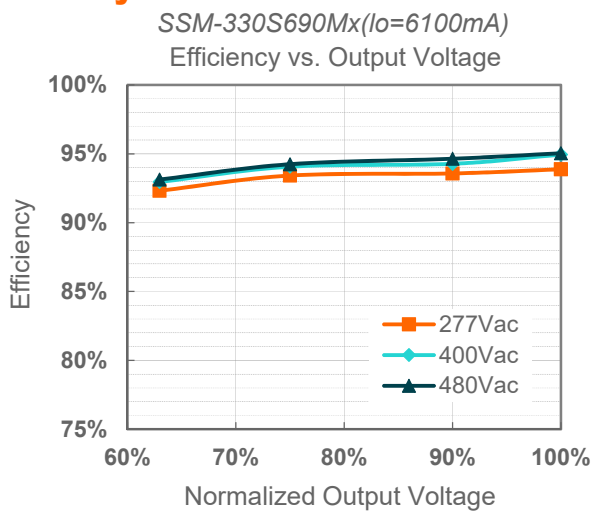

## Power Factor

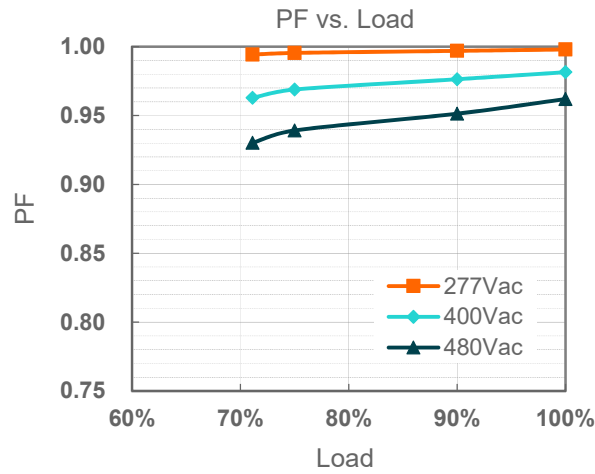

## Total Harmonic Distortion

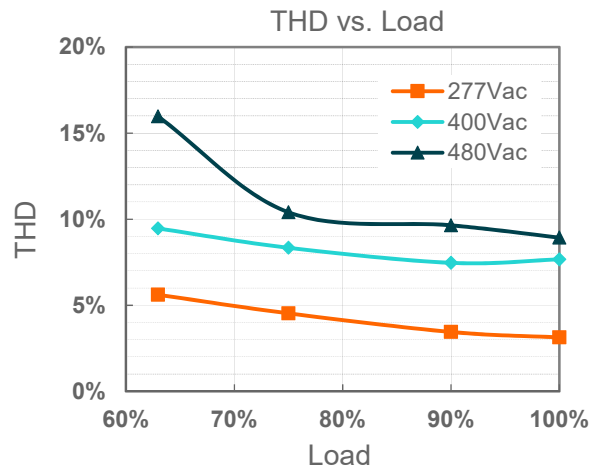

## Protection Functions

| Parameter                   | Notes  |
|-----------------------------|--|
| Over Voltage Protection     | Limits output voltage at no load and in case the normal voltage limit fails.   |
| Short Circuit Protection    | Auto Recovery. No damage will occur when any output is short circuited. The output shall return to normal when the fault condition is removed. |
| Over Temperature Protection | Decreases output current, returning to normal after over temperature is removed.   |

## Dimming

### ● 0-10V Dimming

The recommended implementation of the dimming control is provided below.

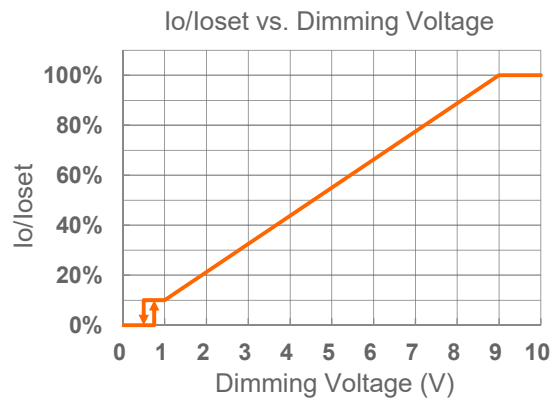
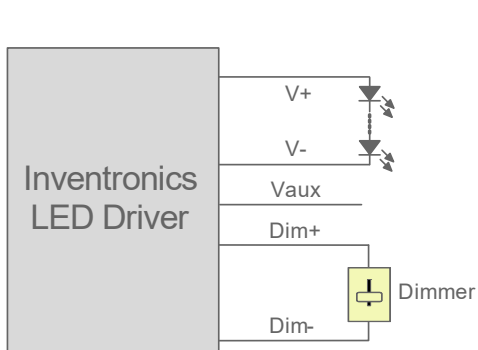

**Implementation 1: Positive logic**

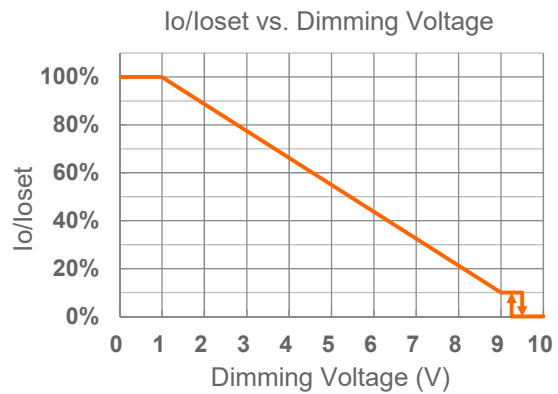
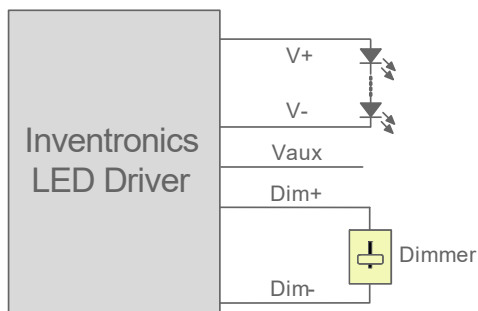

**Implementation 2: Negative logic**

**Notes:**

1. Do NOT connect Dim- to the output V- or V+, otherwise the driver will not work properly.
2. The dimmer can also be replaced by an active 0-10V voltage source signal or passive components like zener.
3. When 0-10V negative logic dimming mode and Dim+ is open, the driver will dim to off and be standby.

**10V PWM Dimming**

The recommended implementation of the dimming control is provided below.

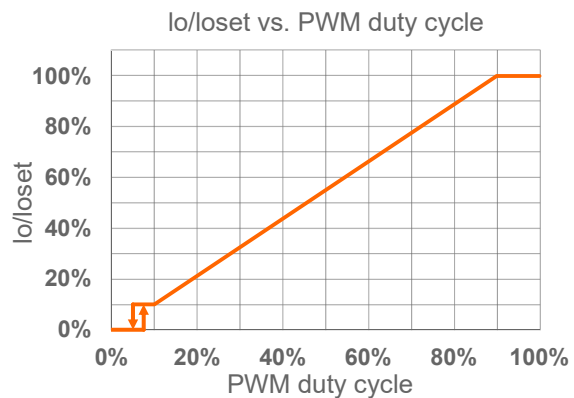
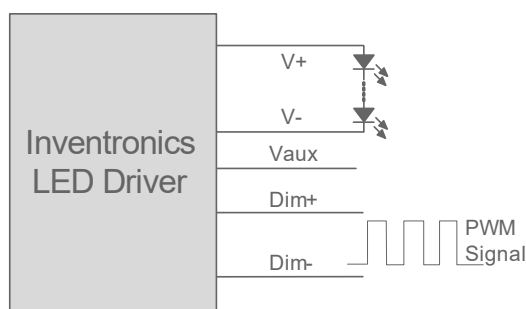

**Implementation 3: Positive logic**



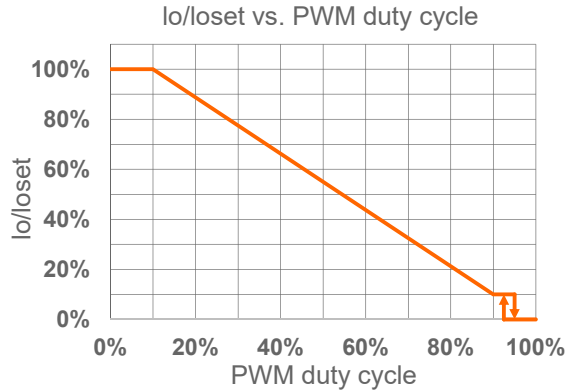
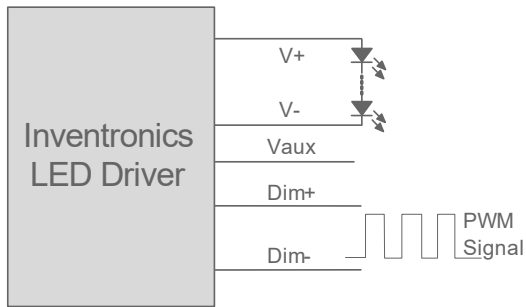

**Implementation 4: Negative logic**

**Notes:**

1. Do NOT connect Dim- to the output V- or V+, otherwise the driver will not work properly.
2. When 10V PWM negative logic dimming mode and Dim+ is open, the driver will dim to off and be standby.

**● Resistor Dimming**

The recommended implementation of the dimming control is provided below.

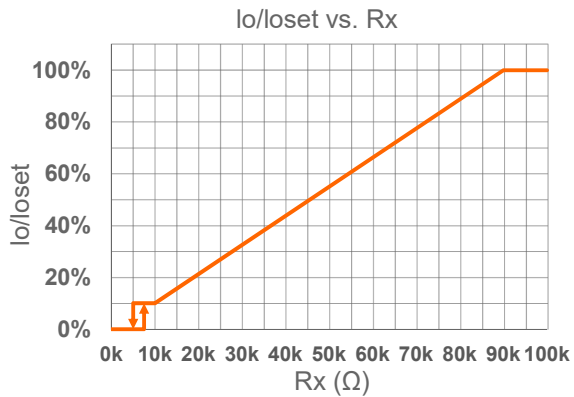
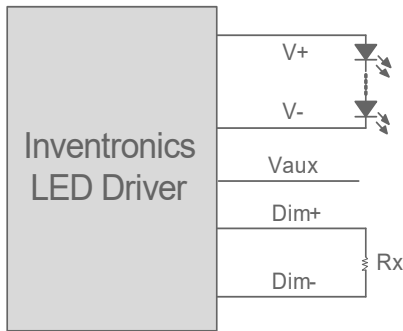

**Implementation 5: Positive logic**

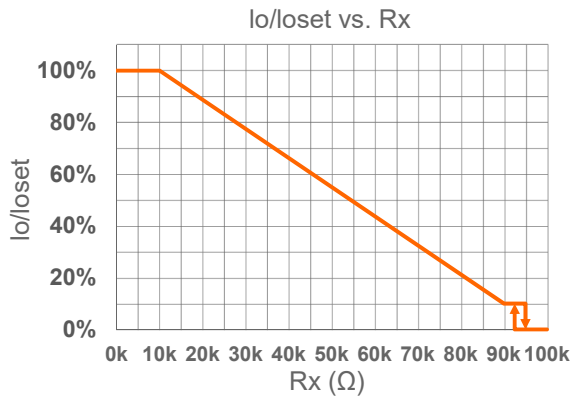
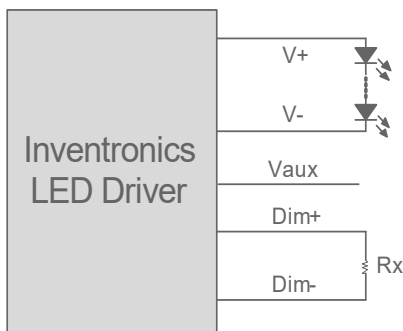

**Implementation 6: Negative logic**

**Notes:**

1. Do NOT connect Dim- to the output V- or V+, otherwise the driver will not work properly.
2. When resistor negative logic dimming mode and Dim+ is open, the driver will dim to off and be standby.

## ● Adjustable Dimming Curve

0-10V dimming curve can be set as corresponding dimming voltage by Inventronics Multi Programmer. Take the positive logic dimming as an example, the recommended implementation of the dimming control is provided below.

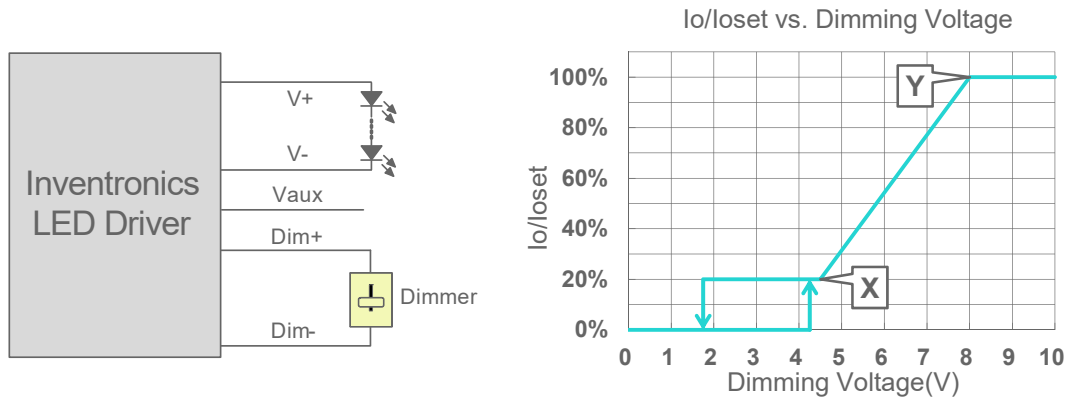

Implementation 7: Positive logic

### Notes:

1. Do NOT connect Dim- to the output V- or V+, otherwise the driver will not work properly.
2. The dimmer can also be replaced by an active 0-10V voltage source signal or passive components like zener.
3. When dimming voltage X point is set to be smaller than Y point, the dimming curve is positive logic; conversely, when X point is set to be bigger than Y point, the dimming curve is negative logic.
4. For best dimming accuracy, the difference between X point and Y point is advised more than 4V.
5. Dimming off voltage adjustable.

## ● Time Dimming

Time dimming control includes 3 kinds of modes, they are Self Adapting-Midnight, Self Adapting-Percentage and Traditional Timer.

- **Self Adapting-Midnight:** Automatically adjusts the dimming curve based on the on-time of past two days (if difference <15 minutes), assuming that the center point of the dimming curve is midnight local time.
- **Self Adapting-Percentage:** Automatically adjusts the on-time of each step by a constant percentage = (actual on-time for the past 2 days if difference <15 min) / (programmed on-time from the dimming curve).
- **Traditional Timer:** Follows the programmed timing curve after power on with no changes.

## ● Output Lumen Compensation

Output Lumen Compensation (OLC) may be used to maintain constant light output over the life of the LEDs by driving them at a reduced current when new, then gradually increasing the drive current over time to counteract LED lumen degradation.

## ● Hold Time Adjustable

When AC power is first applied to the LED driver, enabling a "Hold" period can allow devices powered by the Auxiliary voltage to stabilize before the driver fades up to the maximum dimming level. During this period, the driver will not respond to external dimming commands but will respond again after the hold time ends. Both the initial dimming percentage and the duration of this hold period can be adjusted by the Inventronics Multi Programmer. This function is disabled by default.

## ● Fade Time Adjustable

There is a "Fade" period after the "Hold" period. The soft-start time and dimming slope applied to all dimming transitions can be adjusted individually. It is adjusted by the Inventronics Multi Programmer. This function is disabled by default.

## ● End Of Life

End-of-Life (EOL) is providing a visual notification to a user that the LED module has reached the end of manufacturer-specified life and that the replacement is recommended. Once active, an indication is given at each power-up of the driver, which the driver indicates this through a lower light output during the first 1 minute before normal operation is continued.

## Programming Connection Diagram

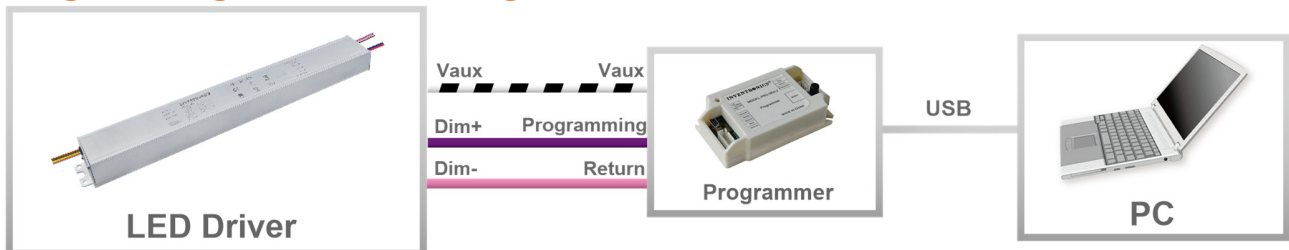

**Note:** The driver does not need to be powered on during the programming process.

● Please refer to [PRG-MUL2 \(Programmer\) datasheet](#) for details.

## Mechanical Outline

SSM-330SxxxMF

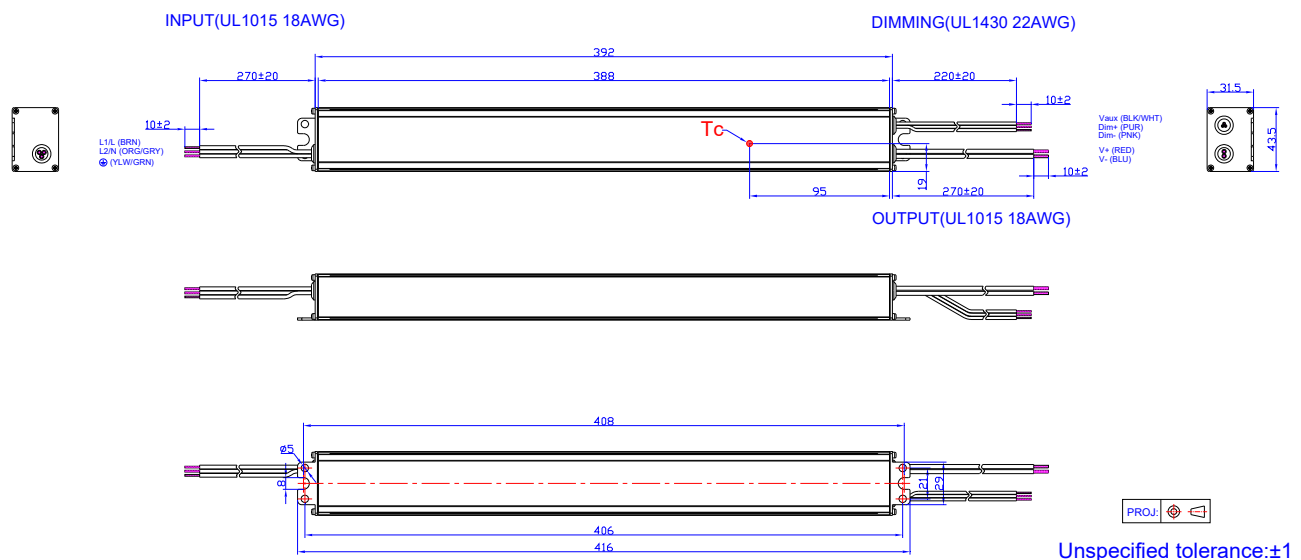

## SSM-330SxxxMG

INPUT (UL SOOW 17AWG/3C & VDE H07RN-F 3\*1.0mm<sup>2</sup>  $\phi$ 9.8)

DIMMING (UL21996 22AWG/3C  $\phi$ 5.0)

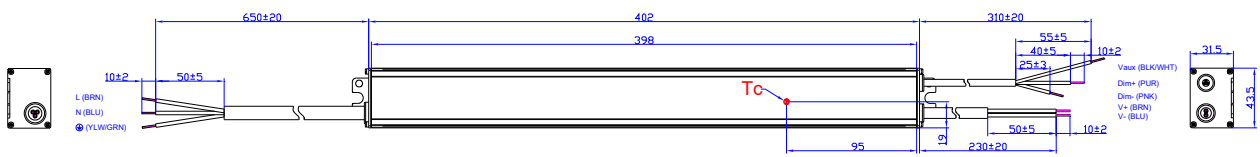

OUTPUT (UL SJOW 17AWG/2C & VDE H05RN-F 2\*1.0mm<sup>2</sup>  $\phi$ 7.8)

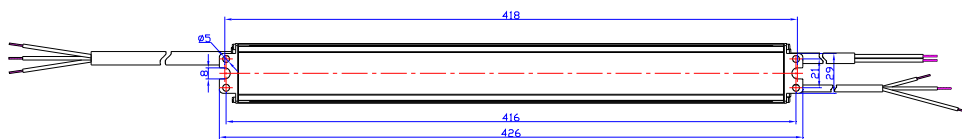

Unspecified tolerance: ±1

## SSM-330SxxxMT

INPUT (UL STW 18AWG/3C  $\phi$ 9.5)

DIMMING (UL21996 22AWG/3C  $\phi$ 5.0)

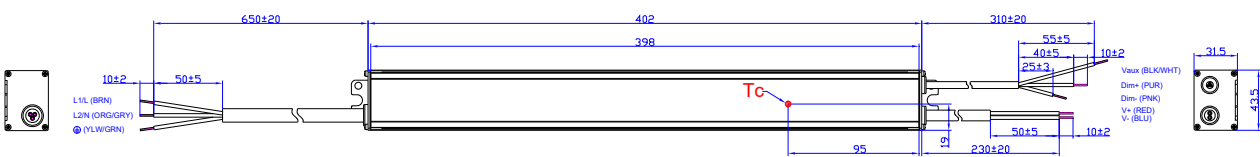

OUTPUT (SJTW 18AWG/2C  $\phi$ 7.3)

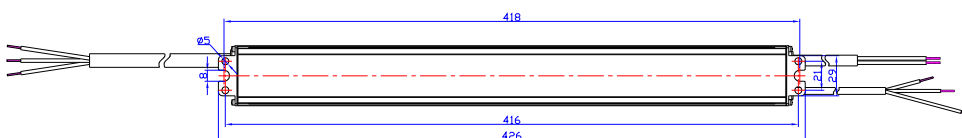
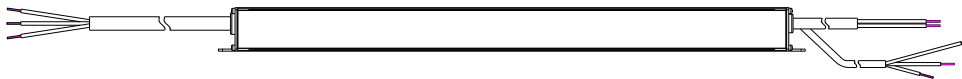

Unspecified tolerance: ±1

## RoHS Compliance

Our products comply with reference to RoHS Directive (EU) 2015/863 amending 2011/65/EU, calling for the elimination of lead and other hazardous substances from electronic products.

## Revision History

| Change Date | Rev. | Description of Change   |      |         |
|-------------|------|-------------------------|------|---------|
|             |      | Item                    | From | To      |
| 2022-06-21  | A    | Datasheet Release       | /    | /       |
| 2024-01-11  | B    | Format                  | /    | Updated |
|             |      | Product Photograph      | /    | Added   |
|             |      | Independent logo        | /    | Added   |
|             |      | Features                | /    | Updated |
|             |      | Models                  | /    | Updated |
|             |      | General Specifications  | /    | Updated |
|             |      | Dimming Specifications  | /    | Updated |
|             |      | Safety & EMC Compliance | /    | Updated |
|             |      | Inrush Current Waveform | /    | Updated |
| Dimming     | /    | Updated                 |      |         |