

Features

- Non-Isolated Class I Driver
- No Afterglow
- Ultra High Efficiency (Up to 98.0%)
- Full Power at Wide Output Current Range (Constant Power)
- Adjustable Output Current (AOC) with NFC
- 0-10V/PWM/Resistor/3-Timer-Modes Dimmable
- Adjustable Dimming Curve
- INV Digital Dimming, UART Based Communication Protocol
- Hold Time Adjustable
- Fade Time Adjustable
- Always-on Auxiliary Power: 12Vdc, 250mA
- Minimum Dimming Level Supports 1%
- Integrated Power Metering with High accuracy up to $\pm 1\%$
- Low Inrush Current
- Output Lumen Compensation
- End-of-Life Indicator
- Input Surge Protection: DM 10kV, CM 10kV
- All-Around Protection: OPP, IOVP, IUVP, OVP, SCP, OTP
- IP66/IP67 and UL Dry/Damp/Wet Location
- TYPE HL, for Use in a Class I, Division 2 Hazardous (Classified) Location
- 5 Years Warranty



Description

The NSM-1K5SxxxMx series is a 1500W, constant-current, programmable and IP66/IP67 rated LED driver that operates from 249-528Vac input with excellent power factor. Created for many lighting applications including high mast, sports, UV-LED and horticulture, etc. It provides an auxiliary voltage and dim-to-off functionality for powering low voltage, wireless controls. The high efficiency of these drivers and compact metal case enables them to run cooler, significantly improving reliability and extending product life. To ensure trouble-free operation, protection is provided against input surge, overpower protection, input under voltage, input over voltage, output over voltage, short circuit, and over temperature.

Models

Adjustable Output Current Range (mA)	Full-Power Current Range (mA) ⁽¹⁾	Default Output Current (mA)	Output Voltage Range (Vdc)	Max. Output Power (W)	Typical Efficiency ⁽²⁾	Typical Power Factor		Model Number ⁽³⁾⁽⁴⁾
						277Vac	480Vac	
30-4800	3000-4800	4800	150-500	1500	97.5%	0.99	0.95	NSM-1K5S480Mx

- Notes:** (1) Output current range with constant power at 1500W.
 (2) Measured at 100% load and 480Vac input (see below "General Specifications" for details).
 (3) Certified voltage range: 277-480Vac
 (4) x=G are UL Recognized, ENEC and CE, etc. models; x=T are UL Class P models.

I-V Operation Area

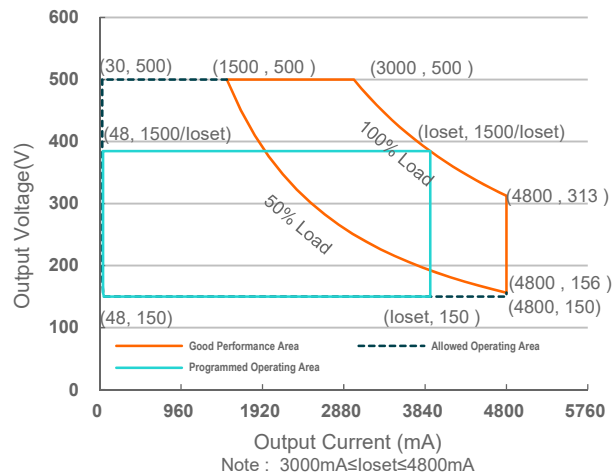

Input Specifications

Parameter	Min.	Typ.	Max.	Notes
Input AC Voltage	249 Vac	-	528 Vac	
Input DC Voltage	352 Vdc	-	500 Vdc	
Input Frequency	47 Hz	-	63 Hz	
Leakage Current	-	-	0.75 MIU	UL 8750; 480Vac/ 60Hz
			0.70 mA	IEC 60598-1; 480Vac/ 60Hz, grounding effectively
Input AC Current	-	-	6.17 A	Measured at 100% load and 277 Vac input.
	-	-	3.64 A	Measured at 100% load and 480 Vac input.
Inrush Current(I ² t)	-	-	2.88 A ² s	At 480Vac input, 25°C cold start, duration=14.3 ms, 10%I _{pk} -10%I _{pk} .
PF	0.90	-	-	At 277-480Vac, 50-60Hz, 50%-100%Load (750 - 1500W)
THD	-	-	20%	

Output Specifications

Parameter	Min.	Typ.	Max.	Notes
Output Current Tolerance	-5%loset		5%loset	At 100% load condition
Output Current Setting(loset) Range				
NSM-1K5S480Mx	48 mA	-	4800 mA	
Output Current Setting Range with Constant Power				
NSM-1K5S480Mx	3000 mA	-	4800 mA	
Total Output Current Ripple (pk-pk)	-	2%I _{omax}	5%I _{omax}	At 100% load condition. 20 MHz BW

Output Specifications (Continued)

Parameter	Min.	Typ.	Max.	Notes
Output Current Ripple at < 200 Hz (pk-pk)	-	1%I _{omax}	-	At 70-100% load condition. Only this component of ripple is associated with visible flicker.
Startup Overshoot Current	-	-	10%I _{omax}	At 100% load condition
No Load Output Voltage NSM-1K5S480Mx	-	-	600 V	
Line Regulation	-	-	±2.5%	Measured at 100% load
Load Regulation	-	-	±5.0%	
Turn-on Delay Time	-	-	0.5 s	Measured at 277-480Vac input, 50%-100% Load
Temperature Coefficient of I _o set	-	0.03%/°C	-	Case temperature = 0°C ~T _c max
12V Auxiliary Output Voltage	10.8 V	12 V	13.2 V	
12V Auxiliary Output Source Current	0 mA	-	250 mA	Return terminal is "DA"
12V Auxiliary Output Transient Peak Current@6W	-	-	500 mA	500mA peak for a maximum duration of 2.2ms in a 6.0ms period during which time the average should not exceed 250mA.
12V Auxiliary Output Transient Peak Current@10W	-	-	850 mA	850mA peak for a maximum duration of 1.3ms in a 5.2ms period during which time the average should not exceed 250mA.

General Specifications

Parameter	Min.	Typ.	Max.	Notes
Efficiency at 277 Vac input: NSM-1K5S480Mx I _o = 3000 mA I _o = 4800 mA	95.0% 95.0%	97.0% 97.0%	- -	Measured at 100% load and steady-state temperature in 25°C ambient; (Efficiency will be about 2.0% lower if measured immediately after startup.)
Efficiency at 400Vac input: NSM-1K5S480Mx I _o = 3000 mA I _o = 4800 mA	96.0% 95.0%	98.0% 97.0%	- -	Measured at 100% load and steady-state temperature in 25°C ambient; (Efficiency will be about 2.0% lower if measured immediately after startup.)
Efficiency at 480 Vac input: NSM-1K5S480Mx I _o = 3000 mA I _o = 4800 mA	95.5% 95.0%	97.5% 97.0%	- -	Measured at 100% load and steady-state temperature in 25°C ambient; (Efficiency will be about 2.0% lower if measured immediately after startup.)
Power Monitoring Accuracy	-1%	-	1%	Measured at 480Vac input and 100% Load
Standby Power	-	1.5 W		Measured at 480Vac/50Hz; Dimming off
MTBF	-	202,000 Hours	-	Measured at 480Vac input, 80%load and 25°C ambient temperature (MIL-HDBK-217F)
Lifetime		120,000 Hours	-	Measured at 480Vac input, 80%Load and 70°C case temperature; See lifetime vs. T _c curve for the details
		59,000 Hours	-	Measured at 277Vac input, 100%Load and 40°C ambient temperature

General Specifications (Continued)

Parameter	Min.	Typ.	Max.	Notes
Operating Case Temperature for Safety Tc _s	-40°C	-	+90°C	
Operating Case Temperature for Warranty Tc _w	-40°C	-	+80°C	Case temperature for 5 years warranty Humidity: 10% RH to 95% RH
Storage Temperature	-40°C	-	+85°C	Humidity: 5%RH to 95%RH
Dimensions Inches (L × W × H) Millimeters (L × W × H)	11.34 × 4.25 × 1.91 288 × 108 × 48.5			With mounting ear 12.20 × 4.25 × 1.91 310 × 108 × 48.5
Net Weight	-	2982 g	-	

Dimming Specifications

Parameter	Min.	Typ.	Max.	Notes	
Absolute Maximum Voltage on the Vdim (+) Pin	-20 V	-	20 V		
Source Current on Vdim (+)Pin	90 uA	100 uA	110 uA	Vdim(+) = 0 V	
Dimming Output range	NSM-1K5S480Mx	1%loset	-	loset	3000 mA ≤ loset ≤ 4800 mA
		30 mA	-	loset	48 mA ≤ loset < 3000 mA
Recommended Dimming Input Range	0 V	-	10 V	0-10V dimming mode.	
Dim off Voltage	0.35 V	0.5 V	0.65 V		
Dim on Voltage	0.55 V	0.7 V	0.85 V		
Hysteresis	-	0.2 V	-		
PWM_in High Level	3 V	-	10 V	Dimming mode set to PWM in Inventronics Programing Software.	
PWM_in Low Level	-0.3 V	-	0.6 V		
PWM_in Frequency Range	200 Hz	-	3 KHz		
PWM_in Duty Cycle	1%	-	99%		
PWM Dimming off (Positive Logic)	3%	5%	8%		
PWM Dimming on (Positive Logic)	5%	7%	10%		
PWM Dimming off (Negative Logic)	92%	95%	97%		
PWM Dimming on (Negative Logic)	90%	93%	95%		
Hysteresis	-	2%	-		

Safety & EMC Compliance

Safety Category	Standard	
UL/CUL	UL 8750,CAN/CSA-C22.2 No. 250.13	
ENEC	EN 61347-1, EN 61347-2-13	
CE	EN 61347-1, EN 61347-2-13 EN 301 489-1 EN 301 489-3 EN 300 330 EN 62479/EN 50663/EN 50665/EN 50364	
CB	IEC 61347-1, IEC 61347-2-13	
CCC	GB 19510.1, GB 19510.14	
global-mark	AS/NZS 61347.1, AS/NZS 61347.2.13	
Performance	Standard	
ENEC	EN IEC 62384	
EMI Standards	Notes	
EN IEC 55015/GB/T 17743 ⁽¹⁾	Conducted emission Test & Radiated emission Test	
EN IEC 61000-3-2/GB 17625.1	Harmonic current emissions	
EN 61000-3-3	Voltage fluctuations & flicker	
FCC Part 15 ⁽¹⁾	ANSI C63.4 Class B	
	This device complies with Part 15 of the FCC Rules. Operation is subject to the following two conditions: [1] this device may not cause harmful interference, and [2] this device must accept any interference received, including interference that may cause undesired operation.	
EMS Standards	Notes	
EN 61000-4-2	Electrostatic Discharge (ESD): 8 kV air discharge, 4 kV contact discharge	
EN 61000-4-3	Radio-Frequency Electromagnetic Field Susceptibility Test-RS	
EN 61000-4-4	Electrical Fast Transient / Burst-EFT	
EN 61000-4-5	AC mains	Surge Immunity Test: AC Power Line: Differential Mode 10 kV, Common Mode 10 kV
	Output	- Common Mode: 3kV Vo+ to PE, Vo- to PE - Differential Mode: 1kV (V+ to V-)
	Dimming	-Common Mode: 3kV Dim+ to PE - Differential Mode: 1kV Dim+ to Dim-
EN 61000-4-6	Conducted Radio Frequency Disturbances Test-CS	
EN 61000-4-8	Power Frequency Magnetic Field Test	
EN 61000-4-11	Voltage Dips	
EN 61547	Electromagnetic Immunity Requirements Applies To Lighting Equipment	

Note: (1) This LED driver meets the EMI specifications above, but EMI performance of a luminaire that contains it depends also on the other devices connected to the driver and on the fixture itself.

● **Isolation Levels between Different Circuits:**

	AC Input	DC Output	Dimming (SELV)	Housing
AC Input	/	No isolation	Double	Basic
DC Output	No isolation	/	Double	Basic
Dimming (SELV)	Double	Double	/	Basic
Housing	Basic	Basic	Basic	/

Lifetime vs. Case Temperature

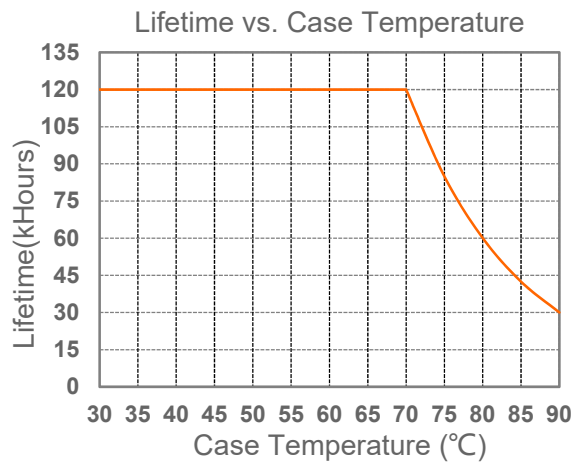

Inrush Current Waveform

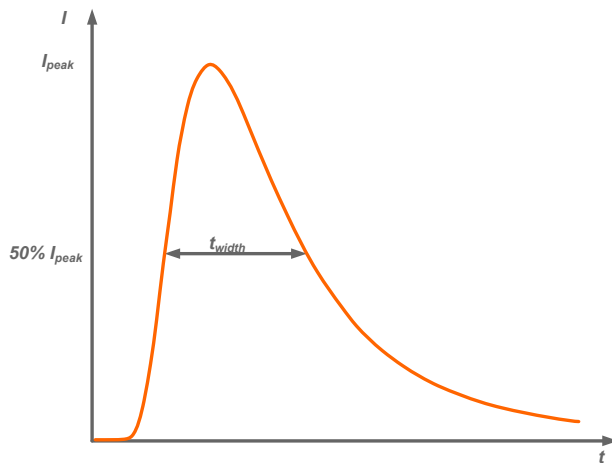

Input AC Voltage	I_{peak}	t_{width} (@ 50% I_{peak})
277Vac	8.35A	4.24ms
400Vac	12.5A	3.84ms
480Vac	16.4A	4.00ms

MCB	Tripping Curves	B	B	B	B	C	C	C	C
	Rated Current	10A	16A	20A	25A	10A	16A	20A	25A
The Number of LED Driver can be Configured	277Vac	1	1	2	2	1	1	2	3
	400Vac	0	1+1+1	1+1+1	2+2+2	1+1+1	1+1+1	2+2+2	2+2+2
	480Vac	1+1+1	1+1+1	2+2+2	2+2+2	1+1+1	1+1+1	2+2+2	3+3+3

Efficiency vs. Load

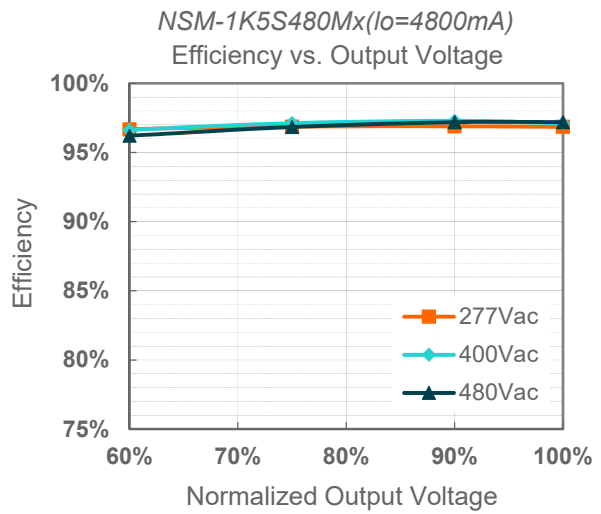
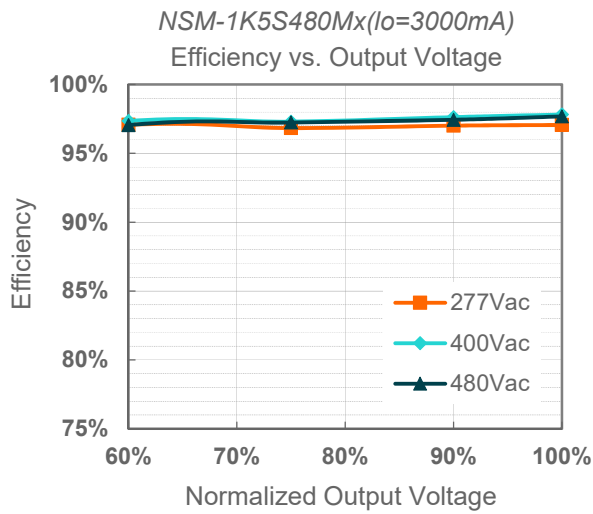

Power Factor

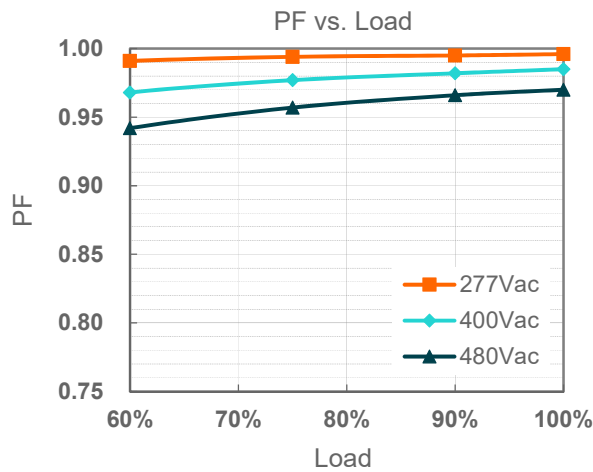

Total Harmonic Distortion

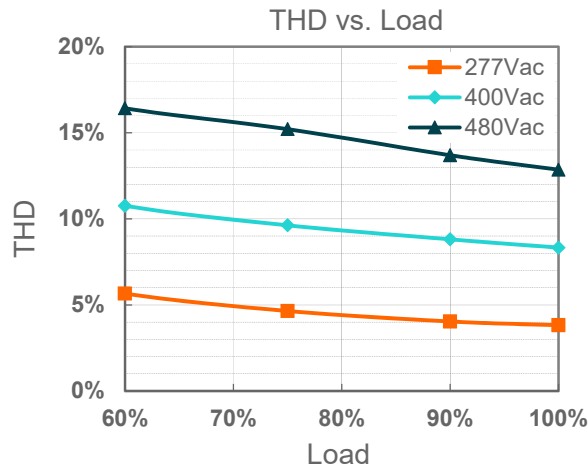

Protection Functions

Parameter		Min.	Typ.	Max.	Notes
Over Temperature Protection		Decreases output current, returning to normal after over temperature is removed.			
Short Circuit Protection		Auto Recovery. No damage will occur when any output is short circuited. The output shall return to normal when the fault condition is removed.			
Over Voltage Protection		Limits output voltage at no load and in case the normal voltage limit fails.			
Over Power protection		Exceeds 1605W (typical), the driver will decrease this channel output current automatically and shall return original current when the fault condition is removed.			
Input Under Voltage Protection (IUVP)	Input Under Voltage Protection	220 Vac	230 Vac	240 Vac	Turn off the output when the input voltage falls below protection voltage.
	Input Under Voltage Recovery	230 Vac	240 Vac	250 Vac	Auto Recovery. The driver will restart when the input voltage exceeds recovery voltage.
Input Over Voltage Protection (IOVP)	Input Over Voltage Protection	550 Vac	570 Vac	590 Vac	Turn off the output when the input voltage exceeds protection voltage.
	Input Over Voltage Recovery	530 Vac	550 Vac	570 Vac	Auto Recovery. The driver will restart when the input voltage falls below recovery voltage.
	Max. of Input Over Voltage	-	-	590 Vac	The driver can survive for 8 hours with a stable input voltage stress of 590Vac.

● **Input Under Voltage Protection Diagram**

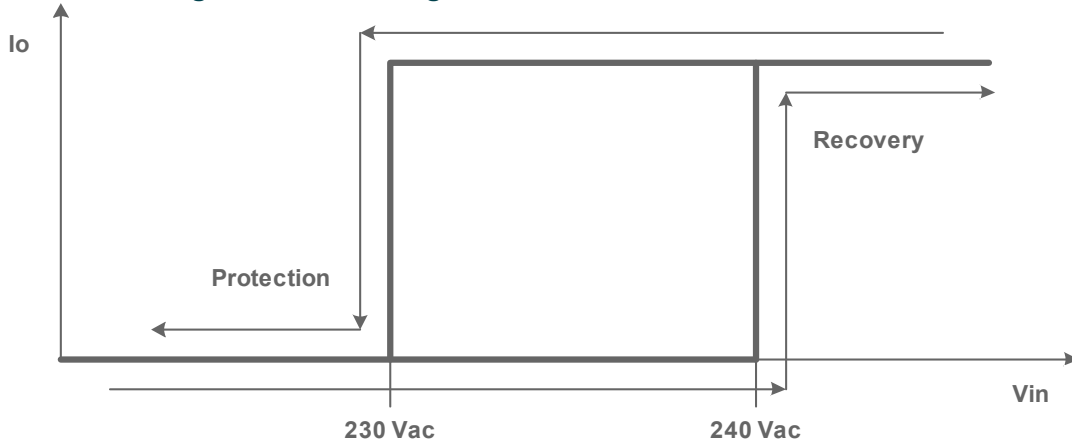

● **Input Over Voltage Protection Diagram**

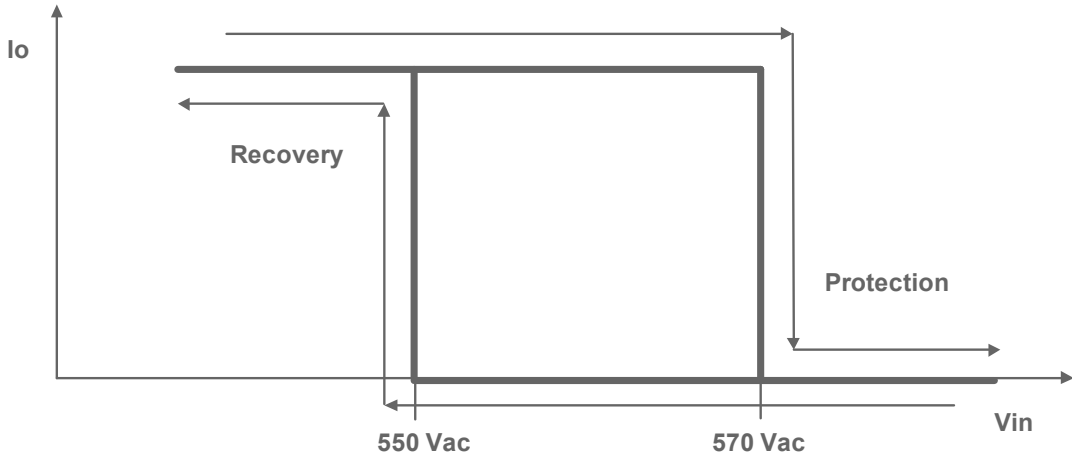

Dimming

● **0-10V Dimming**

The recommended implementation of the dimming control is provided below.

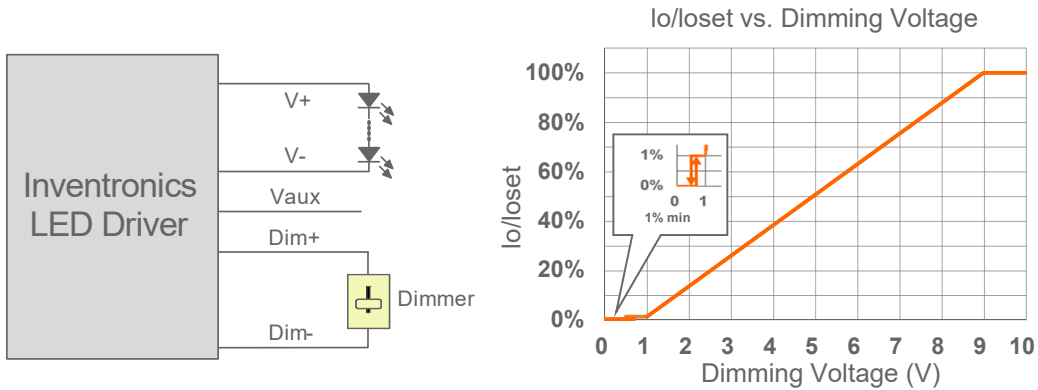

Implementation 1: Positive logic

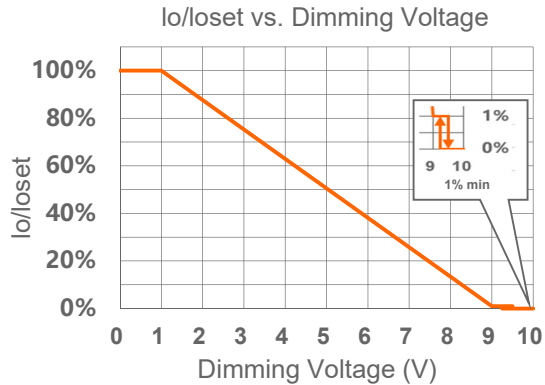
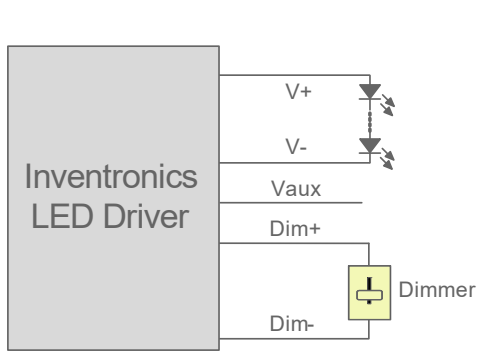

Implementation 2: Negative logic

Notes:

1. Do NOT connect Dim- to the output V- or V+, otherwise the driver will not work properly.
2. The dimmer can also be replaced by an active 0-10V voltage source signal or passive components like zener.
3. When 0-10V negative logic dimming mode and Dim+ is open, the driver will dim to off and be standby.

● PWM Dimming

The recommended implementation of the dimming control is provided below.

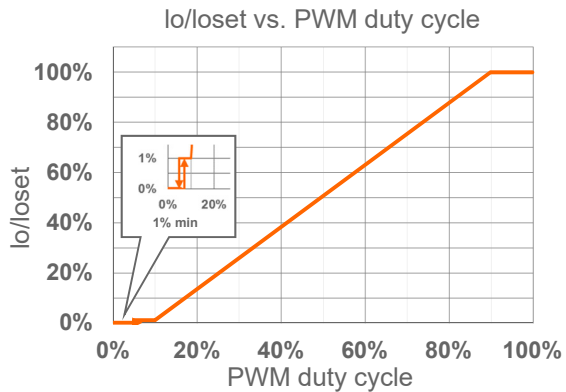
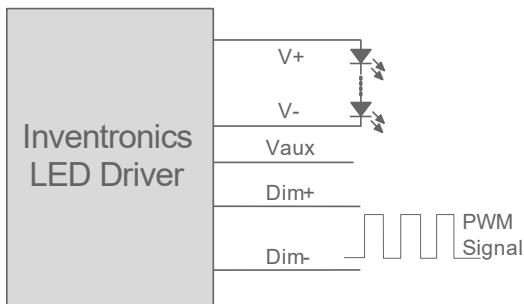

Implementation 3: Positive logic

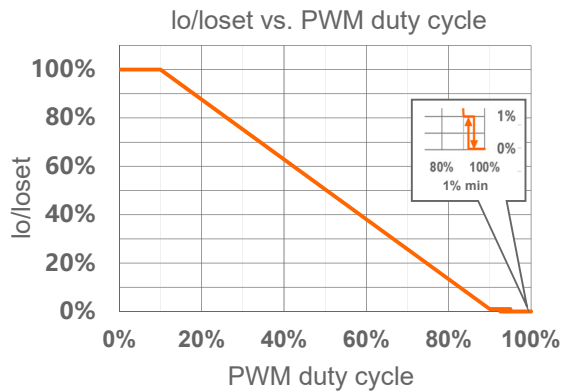
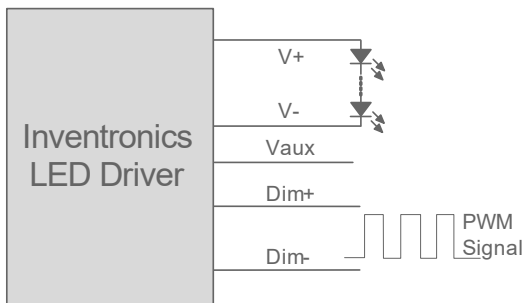

Implementation 4: Negative logic

Notes:

1. Do NOT connect Dim- to the output V- or V+, otherwise the driver will not work properly.
2. When PWM negative logic dimming mode and Dim+ is open, the driver will dim to off and be standby.

● **Resistor Dimming**

The recommended implementation of the dimming control is provided below.

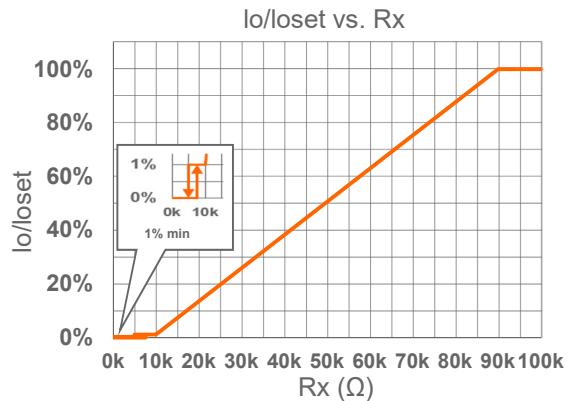
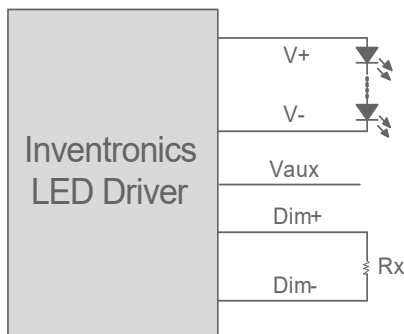

Implementation 5: Positive logic

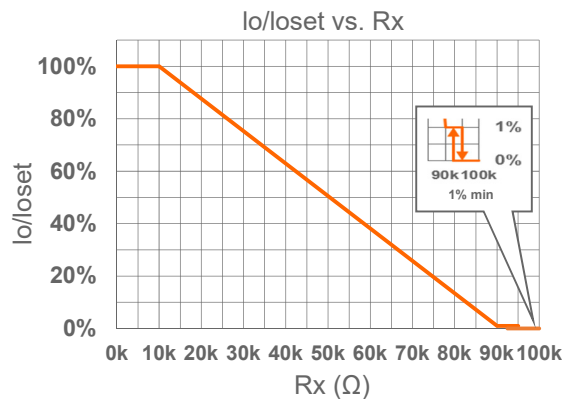
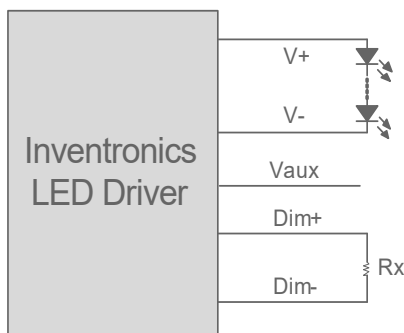

Implementation 6: Negative logic

Notes:

1. Do NOT connect Dim- to the output V- or V+, otherwise the driver will not work properly.
2. When resistor negative logic dimming mode and Dim+ is open, the driver will dim to off and be standby.

● **Adjustable Dimming Curve**

0-10V dimming curve can be set as corresponding dimming voltage by Inventronics Multi Programmer. Take the positive logic dimming mode as an example, the recommended implementation of the dimming control is provided below.

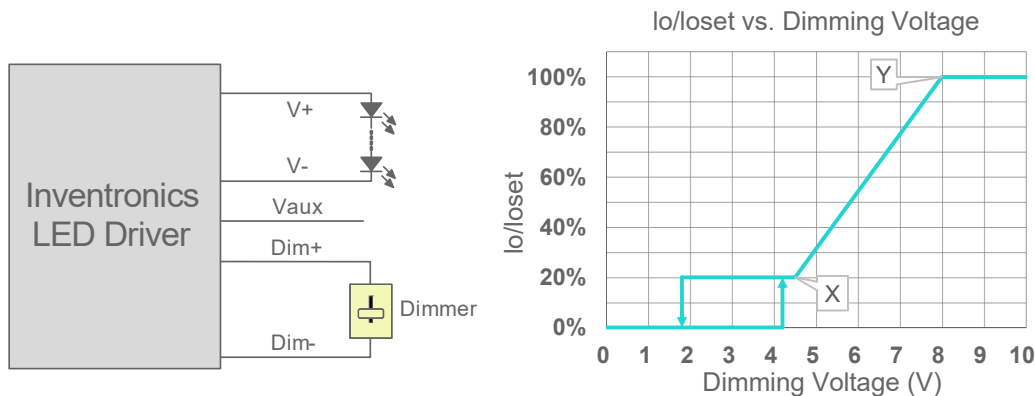

Implementation 7: Positive logic

Notes:

1. Do NOT connect Dim- to the output V- or V+, otherwise the driver will not work properly.
2. The dimmer can also be replaced by an active 0-10V voltage source signal or passive components like zener.
3. When dimming voltage X point is set to be smaller than Y point, the dimming curve is positive logic; conversely, when X point is set to be bigger than Y point, the dimming curve is negative logic.
4. For best dimming accuracy, the difference between X point and Y point is advised more than 4V.
5. Dimming off voltage Adjustable.

● Time Dimming

Time dimming control includes 3 kinds of modes, they are Self Adapting-Midnight, Self Adapting-Percentage and Traditional Timer.

- **Self Adapting-Midnight:** Automatically adjusts the dimming curve based on the on-time of past two days (if difference <15 minutes), assuming that the center point of the dimming curve is midnight local time.
- **Self Adapting-Percentage:** Automatically adjusts the on-time of each step by a constant percentage = (actual on-time for the past 2 days if difference <15 min) / (programmed on-time from the dimming curve).
- **Traditional Timer:** Follows the programmed timing curve after power on with no changes.

● Output Lumen Compensation

Output Lumen Compensation (OLC) may be used to maintain constant light output over the life of the LEDs by driving them at a reduced current when new, then gradually increasing the drive current over time to counteract LED lumen degradation.

● Hold Time Adjustable

When AC power is first applied to the LED driver, enabling a "Hold" period can allow devices powered by the Auxiliary voltage to stabilize before the driver fades up to the maximum dimming level. During this period, the driver will not respond to external dimming commands but will respond again after the hold time ends. Both the initial dimming percentage and the duration of this hold period can be adjusted by the Inventronics Multi Programmer. This function is disabled by default.

● Fade Time Adjustable

There is a "Fade" period after the "Hold" period. The soft-start time and dimming slope applied to all dimming transitions can be adjusted individually. It is adjusted by the Inventronics Multi Programmer. This function is disabled by default.

● **End Of Life**

End-of-Life (EOL) is providing a visual notification to a user that the LED module has reached the end of manufacturer-specified life and that the replacement is recommended. Once active, an indication is given at each power-up of the driver, which the driver indicates this through a lower light output during the first 1 minute before normal operation is continued.

● **Digital Dimming**

Inventronics Digital Dimming is a UART (Universal Asynchronous Receive Transmitter) based communication protocol. Please refer to [Inventronics Digital Dimming](#) file for details.

Programming Connection Diagram

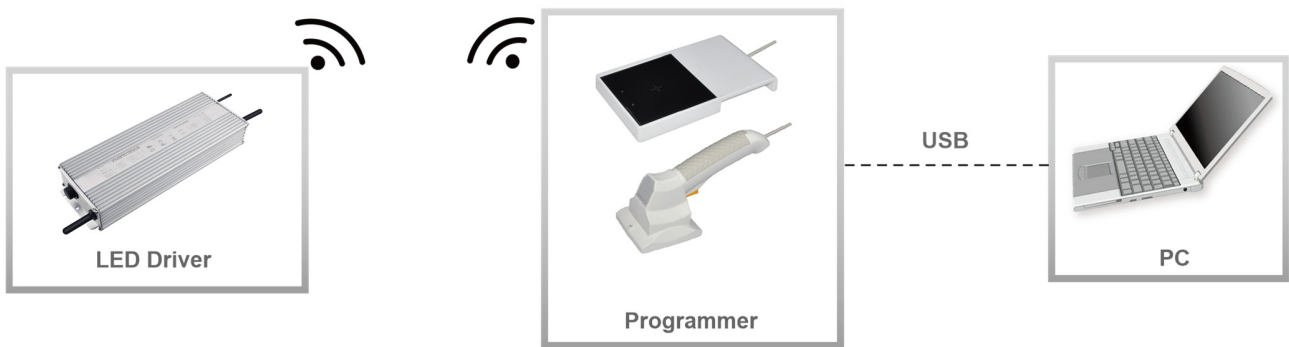

Note: The driver does not need to be powered on during the programming process.

● Please refer to [PRG-NFC-H](#) or [PRG-NFC-D2](#) (Programmer) datasheet for details.

Mechanical Outline

NSM-1K5S480MG

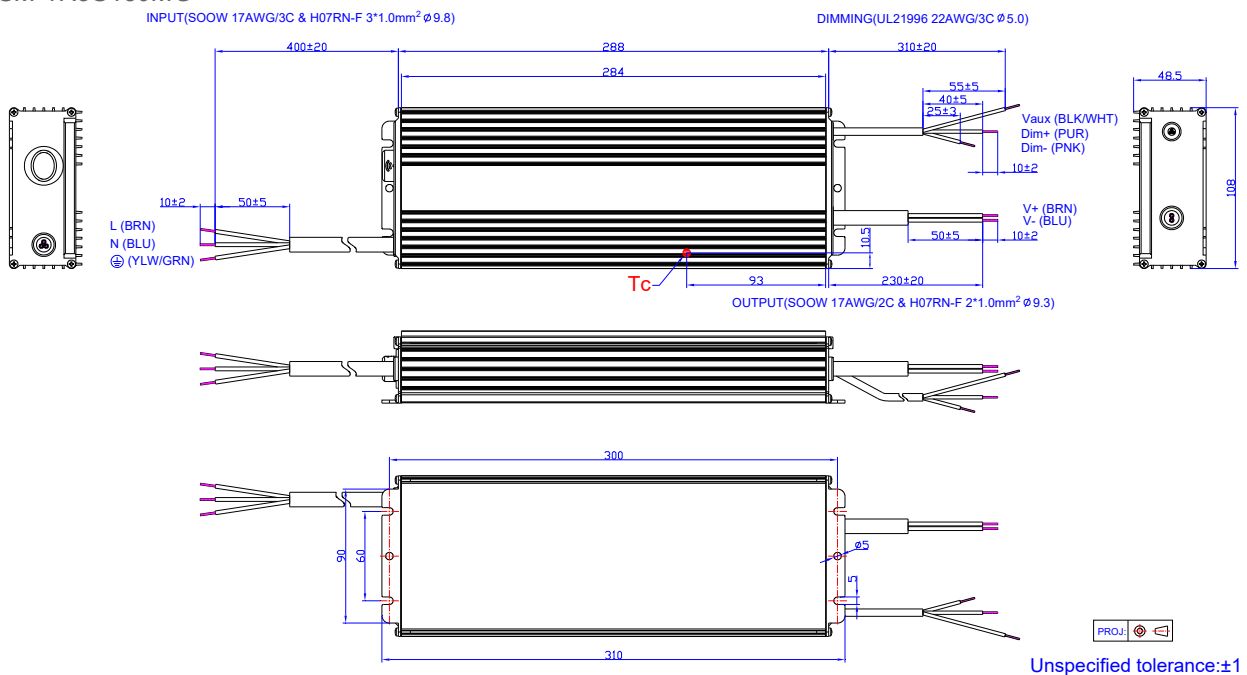

NSM-1K5S480MT

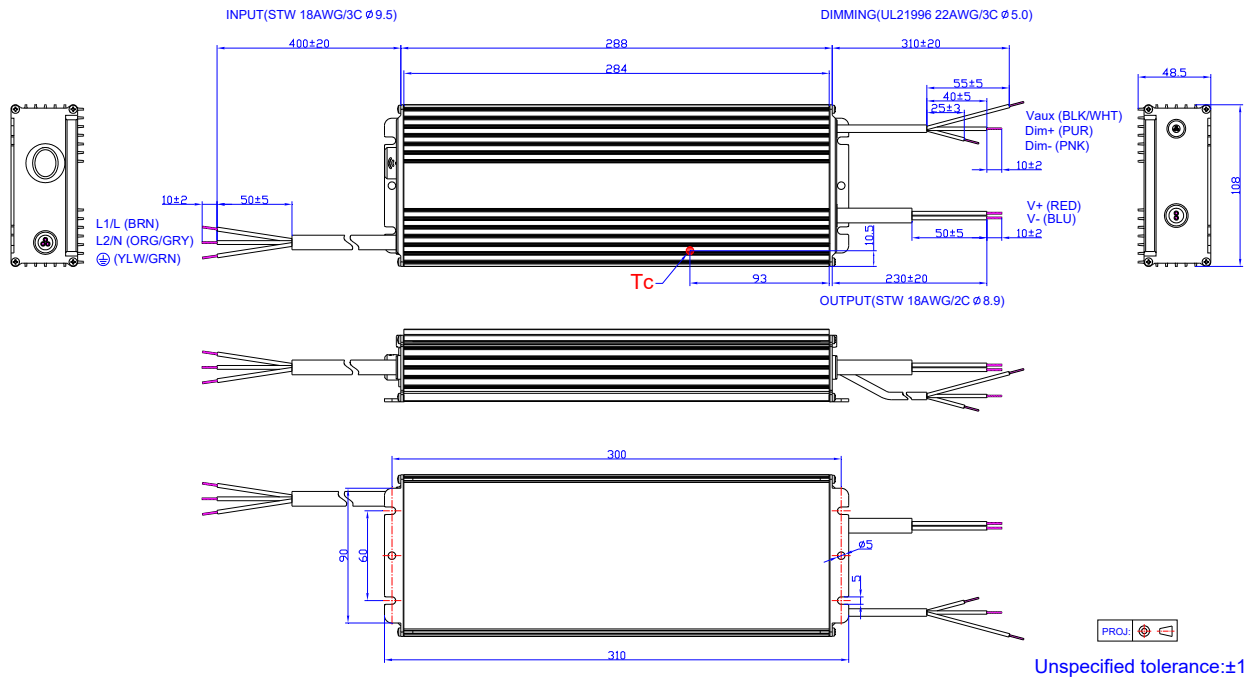

Installations

To download the Installation Guidelines, please click here: [Inventronics Considerations for Non-Isolated LED Drivers.](#)

RoHS Compliance

Our products comply with reference to RoHS Directive (EU) 2015/863 amending 2011/65/EU, calling for the elimination of lead and other hazardous substances from electronic products.

Revision History

Change Date	Rev.	Description of Change		
		Item	From	To
2024-07-09	A	Datasheet Release	/	/