

LUM-030S100MTF

Dimmable Constant Current LED Power Supply

Inventronics LUM Power Supply is the reliable choice for linear and area fixtures for office - industrial – shop – retail

Benefits

- 1% dimming capability with Dim to Off
- Programming via Inventronics PC programmer / Tuner4TRONIC
- Very low ripple for high lighting quality
- 12V Aux included
- Long lasting and high reliability
- UL Class 2

Applications

- Linear and area lighting
- Office – industrial – shop – retail

Approbations & Certifications

FCC / cULus / Class P

In preparation, if not already printed on the label



CLASS P

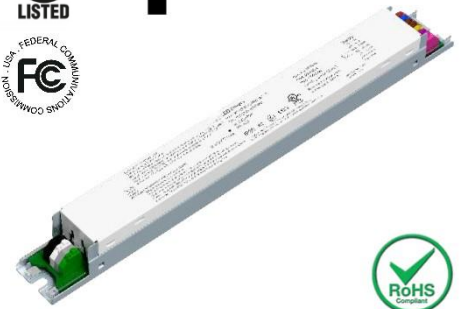

Size	Unit	Inch	Millimeter
Case Length		11.02	280.00
Case Width		1.14	29.00
Case Height		1.02	26.00
Mounting Length		10.63	270.00
Connectors		UL, KF250-3.5, 250-402 Push Pin or equivalent	

Product Features

- 1% dimming capability incl. Dim to Off
- 0-10V / PWM dimming
- Low THD $\leq 20\%$ @ full load
- Input voltage: 120 – 277V
- Very wide ambient temperature range
- Programmable drivers
- Low flicker index $< 5\%$
- 12Vaux included
- Long lifetime up to 100k hours
- 5 years warranty

	Item	Value	Unit	Remarks
INPUT	Nominal voltage	120 – 277	V	
	Nominal frequency	50 / 60	Hz	Max 47 – 63Hz
	AC voltage range	108 – 305	V	
	Input current AC	0.32/0.14	mA	120, 277V
	Total Harmonic Distortion (THD)	≤ 20	%	120Vac / 277Vac output ≥ 50% load
	Stand-by power	≤ 1	W	Dim to Off / no AUX
	Power factor	≥ 0.9		120Vac / 277Vac output ≥ 50% load
	Efficiency	Up to 85	%	Full load without AUX
	Leakage current	300 / 750	µA	120Vac/277 Vac / 60Hz Input, Output Full Load
	Inrush current max	2.5A / 8.7A typ	A	120Vac / 277Vac Typical / $t_{width} = 40 \mu s$ typical (max)
OUTPUT	Nominal voltage range	10 - 55	Vdc	59V max
	Maximum voltage	59	Vdc	120V-277Vac / 60Hz Input
	Nominal current range	100 – 1050	mA	
	Current accuracy	+/- 5	%	at 120-277Vac nominal voltage
	Flicker index	< 5	%	Full load
	Max. power	30	W	
	Start-Up Time	500	ms	120/277Vac / 60Hz Input, Output Full load
DIMMING	Dimming technology	0-10V / PWM		Linear & log dimming curve / PWM frequency: 200Hz – 2kHz
	12V auxiliary output	10.8 / 12.0 / 13.2	V	Min./Typ./Max. – yellow wire
	12V auxiliary current	200	mA	
	0-10V dimming	0 / 10 / 15	V	Min./Typ./Max. – purple wire
	Output source current	200	µA	Max. – purple Wire
Dimming range	1-100%	%	1% dimming capability	
ENVIRONMENT	Ambient temperature range t_a	-40 ... +50	°C	50W
	Maximum case temperature t_c	90	°C	
	Storage temperature range	-40 ... +85	°C	
	Relative humidity	5 ... 85	%	Not condensing
	Surge transient protection	2 4	kV	L-N; L-FG & N-FG
	Environmental rating	Indoor		
	IP rating	IP 20		
	Expected lifetime	50'000 100'000	h	$t_c = 80^\circ C$ $t_c = 70^\circ C$

Wiring diagram

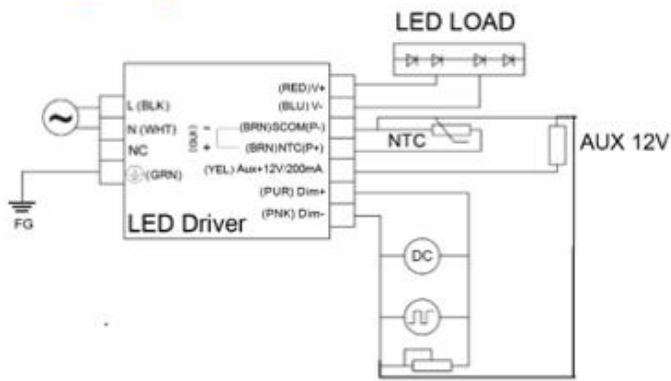

Installation / wiring

Wire preparation:
0.5-1.5mm²

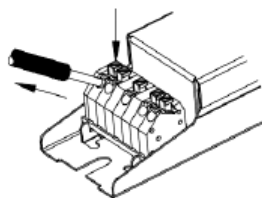
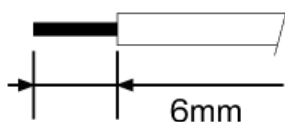

Only Solid wire with a cross section of 0.5 – 1.5 mm².

Strip 6mm of insulation from the cables to ensure perfect operation of terminals

Operating window

Operating Window

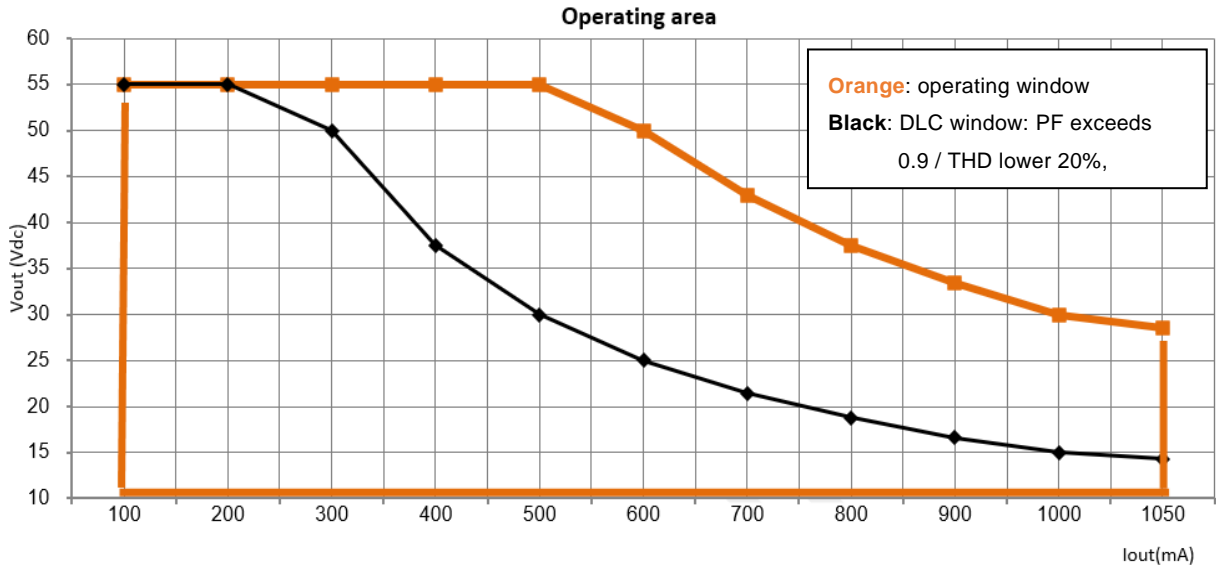

Efficiency vs power

Typical Efficiency vs. Pout at 25°C Ambient Temp

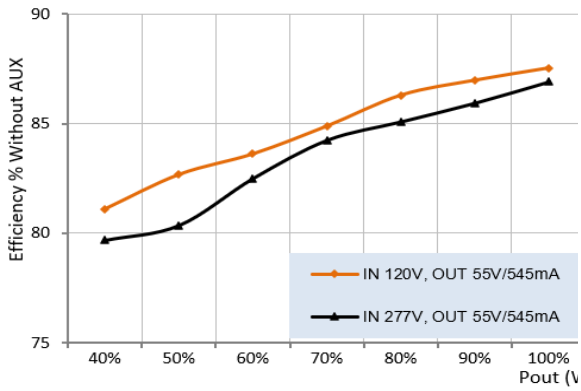

PF vs power

Typical PF vs. Pout at 25°C Ambient Temp

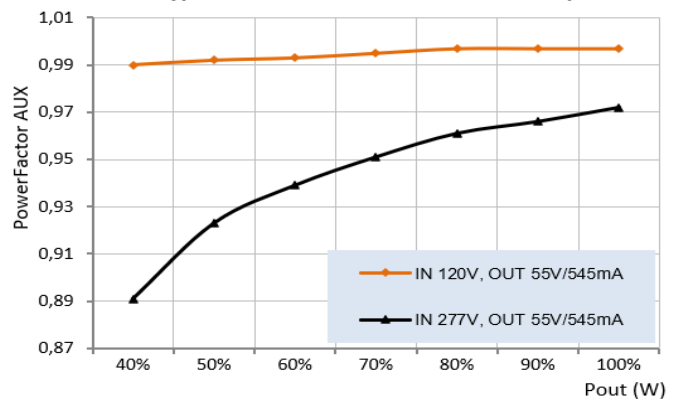

THD vs power

Typical THD vs. Pout at 25°C Ambient Temp

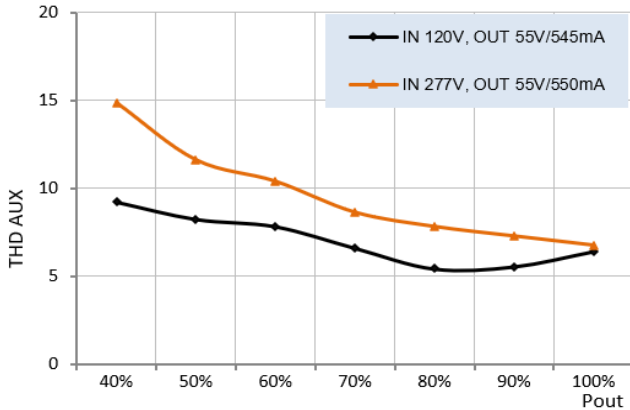

Overtemperature protection behavior

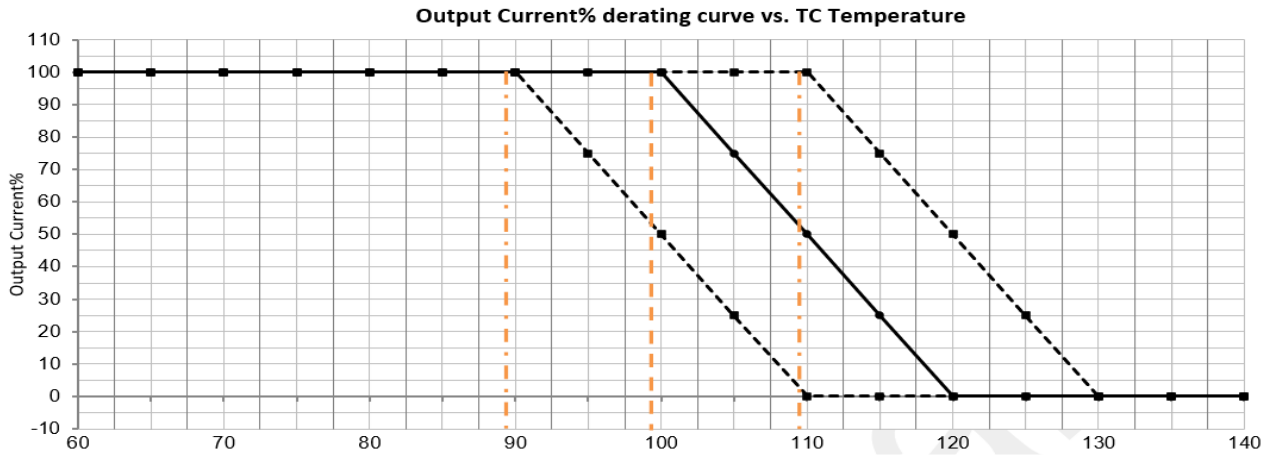

0-10V dimming curve @ minimum dimming set to 1%

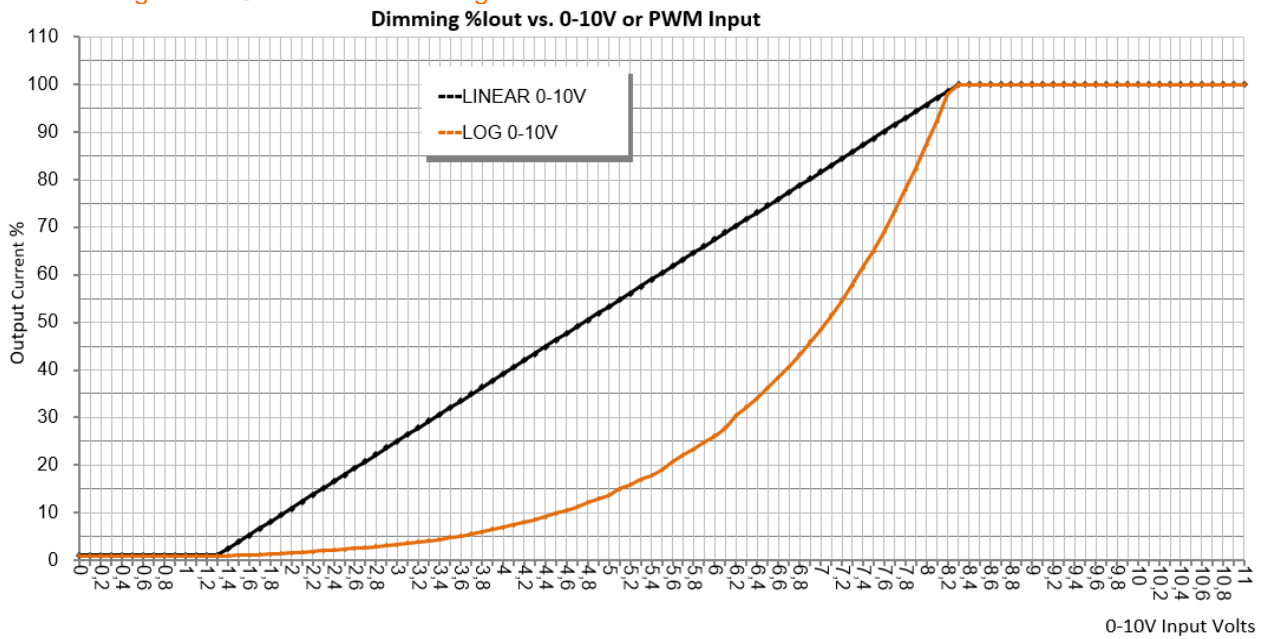

1-10V Dimming curve @ minimum dimming set to 1%

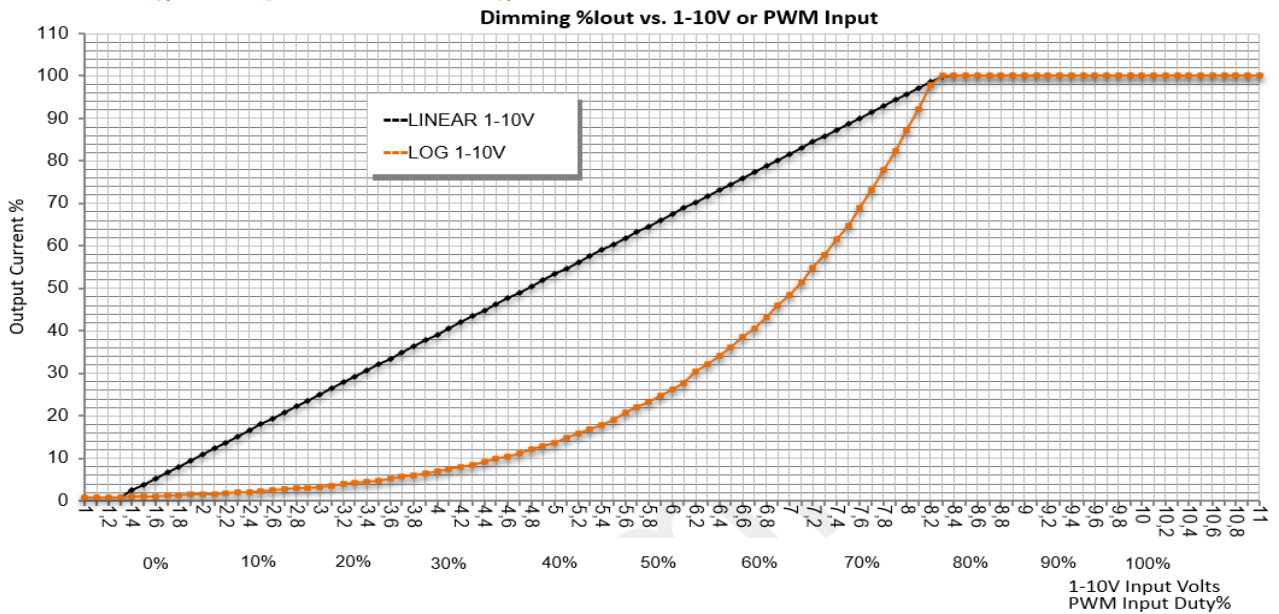

Lifetime vs TCase

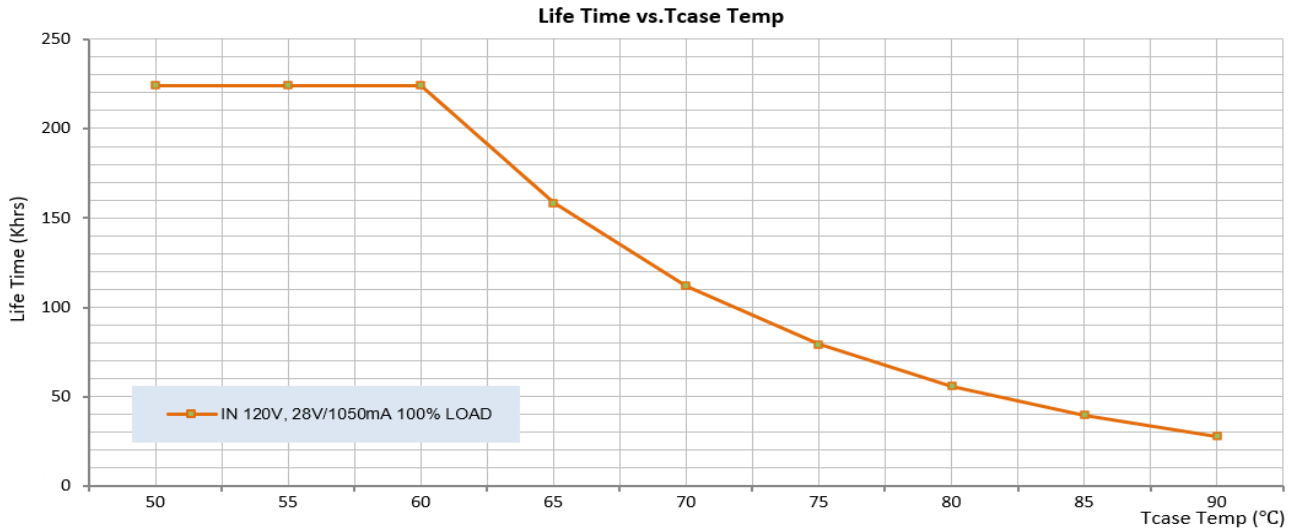

Programming & current setting

Operating Mode: Default | LUD-050S140MTF - Eng.Sample

Output Current

Constant Lumen

End of Life

Thermal Protection

Dimming

Current Mode: FixedCurrent

Fixed Current Settings:

Minimum Current	Operating Current	Maximum Current
400 mA	400 mA	1400 mA

Please use the Inventronics Programmer (Hardware) and Tuner4TRONIC (Software) to program current / features. For further information please refer to www.tuner4tronic.com

Protections

- Output short circuit
- Output over current
- Over temperature protection
- Output over voltage

Programmable features

- Output current
- NTC
- Soft start
- Dim to off
- End-of-life indicator
- Dimming curve
- Constant lumen

Safety / EMC compliance

UL / cUL	UL8750, CSA-C22.2, Class 2, UL Class P
FCC	FCC Part 15 Subpart B, Class A
Ring Wave	NEMA SSL1

Ordering information

Product Naming	Ordering Code / EAN (single)	Part Number	Pieces / Package
LUM-030S100MTF	6937186100085	9LUM030S100MTF0000	40

Inventronics
 2825 S. Tulsa Avenue
 Oklahoma City OK 73108
 United States
www.inventronicsglobal.com

inventronics